

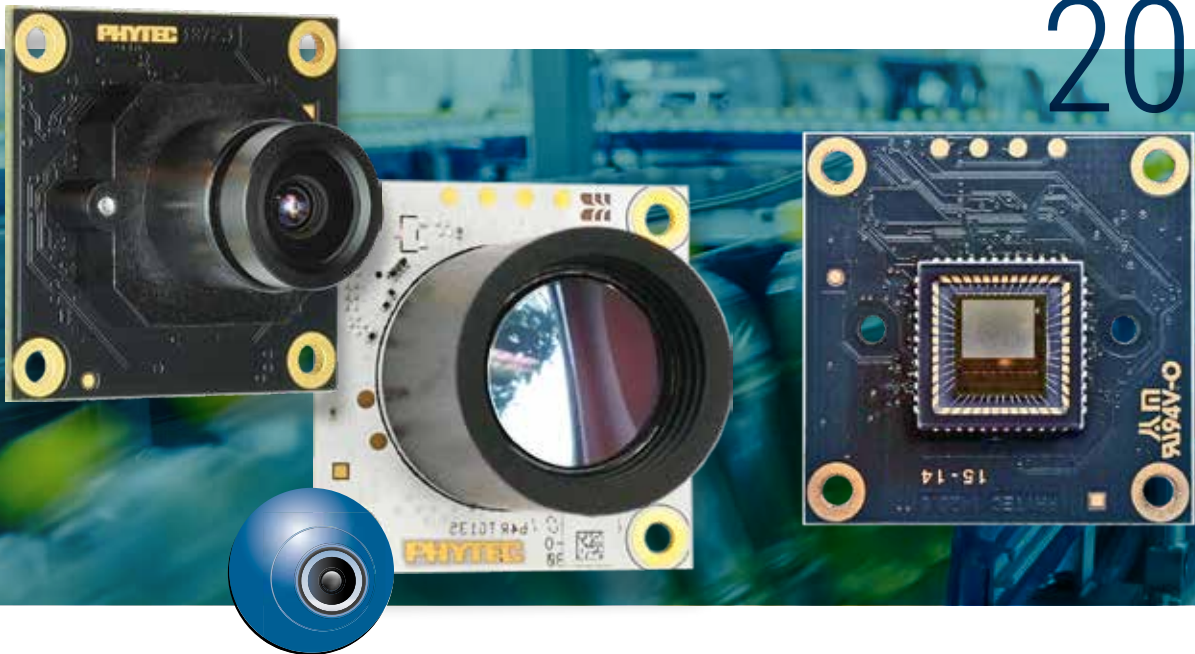

PHYTEC

Components and Solutions
for Your Individual Products.

Embedded Vision 2024



phyCAM[®]

phyCAM-M-mini
smallest Board-Level Camera
for M12 Lenses

phyCAM-L
Board-Level Camera with
up to 15 m Camera Cable

VM-020
2MPixel Full HD Camera Module
with Global Shutter

phyCORE-i.MX 8M Plus
powerful
computer module
with ISP and NPU

phyCORE-AM68x/TDA4VM
Module for Image Processing
with ARM Cortex A72 and
8 TOPS KI-Accelerator

phyCORE-i.MX 8M Mini/Nano
Low-Cost
Computer Module
for Image Processing

phyCORE-STM32MP157
Low-Cost
Processor Module with
parallel Camera Interface

Content

About Us	3
phyCAM – Imaging System	4
The Embedded Imaging Concept	6
phyCAM-M / phyCAM-L	7
phyCAM-M-mini	8
Global Shutter Camera Modules	10
5 MPixel Camera Modules	11
phyCAM-M / VM-X20	12
phyCAM-L / phyCAM-L-mini	14
phyCAM-L Starterkits	16
Phytec Design-Service	18
Processor Modules Embedded Imaging	20
PHYTEC ISP-Kalibrierungsservice	21
phyCORE-i.MX 8M Plus	22
phyBOARD-Pollux	23
phyCORE-i.MX 8M Mini/Nano	24
phyBOARD-Polis	25
phyCORE-STM32MP157	26
phyBOARD-Sargas	27
Software – BSP and Middleware	28
Lenses and Optic Services	30
OVERVIEW TABLES	
all Camera Modules	32
all Processor platforms	34



Transport Security

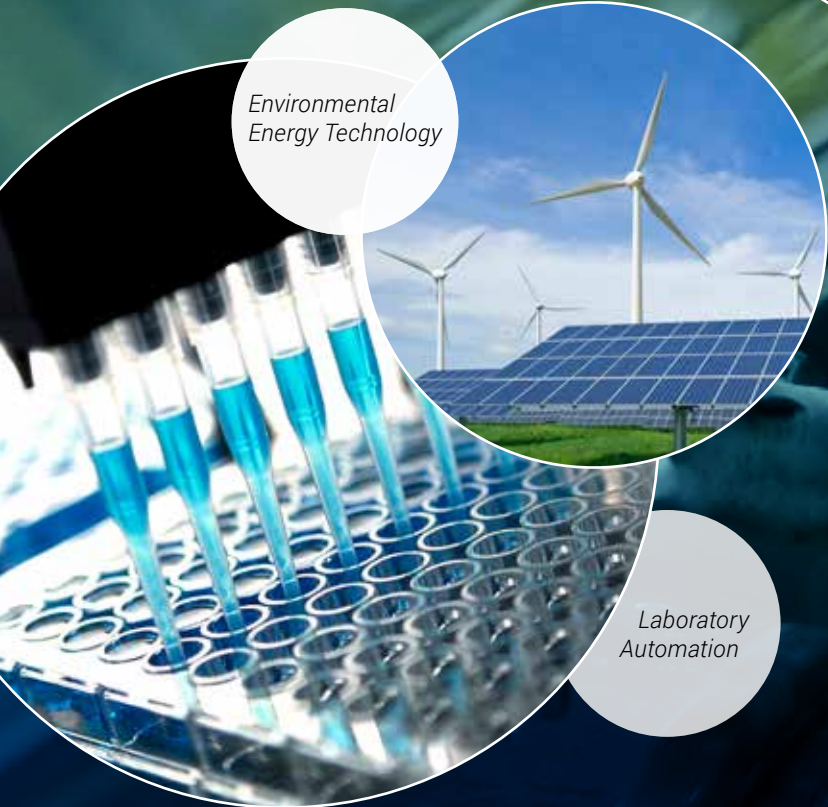

Laboratory Automation



Environmental Energy Technology

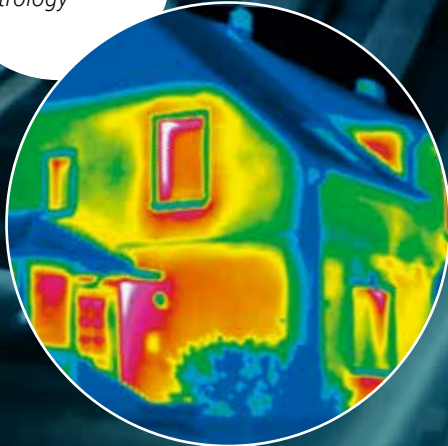

Quality Assurance Metrology

Embedded Imaging We integrate professional image processing into your device

Embedded Imaging is the key to the perfect integration of image processing into your serial device – efficient, cost-effective and optimized for production in quantities. Powerful microcontrollers with integrated camera interface make the implementation of camera sensors easy and cost-effective. At PHYTEC, digital image processing is embedded in a wide range of microcontroller modules and development services.

The special requirements of image processing tasks are taken into account by our own "Digital Imaging" product division. Here, experts develop ready-to-use, scalable concepts that can be directly incorporated into our customers' end products.

Efficient Solutions

The optimal integration of image processing into a series product always requires an individual approach. The planning covers the entire system to be developed. Optics and illumination, image resolution and computing power must be harmonized with other parameters such as other functions, device size, power consumption and last but not least, economic factors. The composition of the right components has a decisive influence on the expenditure required to implement the overall solution.

Our experts will advise you individually on your project and develop adapted or customized solutions for you.

"Our goal is to increase the benefits of image processing in serial products. Take advantage of the many investments we have made for you."

*Martin Klahr
Head of Image Processing Division*



Offer subject to change.
All information is subject to change or error.

phyCAM-Imaging System

The flexible modular solution for Digital Image Products

phyCAM – Imaging with System – The phyCAM concept enables the simple integration of camera sensors into embedded imaging systems. Four interface systems allow optimal adaptation to the circumstances:

phyCAM-M – Our standard solution for modern processors with MIPI CSI-2 interface. The phyCAM-M-interface is based on the MIPI CSI-2 standard and furthermore defines a connector for professional applications. This makes different camera modules compatible. The internal cable routing can be up to 15 cm and can be planned flexibly. The phyCAM-M connector considers different supply voltages and additional latency-free control lines.

phyCAM-L – Line lengths up to 15 m for MIPI CSI-2 based systems. To overcome the length limitations of MIPI CSI-2, phyCAM-L uses the FPD-Link III transmission format from the automotive sector. Alternatively, V³Link, which is compatible with FPD-Link, can also be used. Image and control data as well as the power supply are transmitted via a single thin coaxial cable between the camera module and the application board. phyCAM-L is suitable for internal device cabling due to its small UMCC connector; for external applications, an RG58 cable, for example, can be used.

phyCAM-L camera modules are compact and cost-effective as a single-board solution. They have an expansion connector on the camera for individual extensions. For very small designs, phyCAM-L is also available as a backplane for the mini camera series. phyCAM-L is suitable for all processors with MIPI CSI-2 interface.

COMPARISON OF phyCAM SYSTEMS

The table shows the most important features at a glance



Features	phyCAM-M	phyCAM-L	phyCAM-P	phyCAM-S+
Transmission Method	MIPI CSI-2	FPD-Link III/ V ³ Link	parallel	LVDS
Max. Cable Length	20 cm	15 m	30 cm	5m
Max. Data Rate	> 10 Gbit/s	4.16 Gbit/s	n/a*	0.64 Gbit/s
Cable Type	FFC/FPC	Koax	FFC	Twisted Pair
Connector	30 pin Hirose	UMCC Gen.1	33 pin FFC 0.5	8 pin Hirose
Special Functions / GPIO	+	+	+	
Supply Voltage	3.3V / 5V	12V**	variabel***	3.3V
Most Cost-Effective Solution	€€€€€	€€€€€	€€€€€	€€€€€

*) not limited by system
 **) 4.5V..13.2V
 ***) variable voltage by control pin

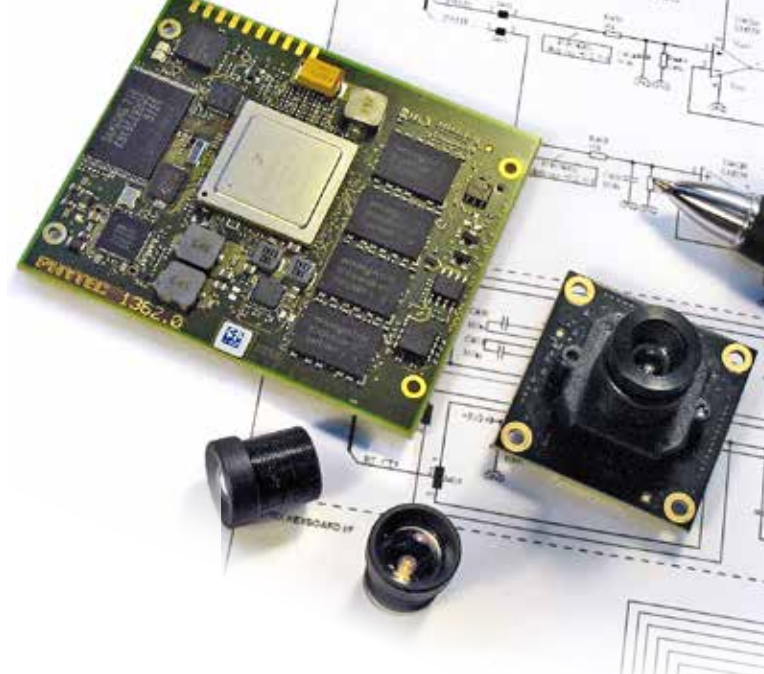

phyCAM-P und phyCAM-S – The phyCAM variants for processors with parallel camera interface. phyCAM-P transmits data, control signals and supply voltage via a 33-pin FFC cable. phyCAM-S converts the image data to LVDS and thereby enables longer camera connections: A phyCAM-S cable requires only eight wires and can be up to five meters long. This also enables the separation of camera head and main unit.

OBJEKTIV-OPTIONEN

All standard size phyCAM boards are available in three lens versions:

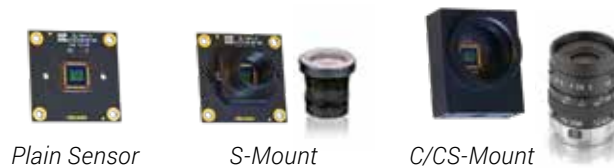

Plain Sensor S-Mount C/CS-Mount

phyCAM mini boards are available as plain sensor and S-Mount (M12) versions.



NEXTSENSE

Customer Testimonial

Nextsense develops hand-held measuring devices for non-contact profile measurement. For example, railway accidents can be avoided by highly accurate wheel profile evaluations. Based on PHYTEC standard components, Nextsense was able to quickly and effectively develop the high-end product CALIPRI.

APPLICATION

- Optical acquisition of 2D geometries using laser light-section technology
- Evaluation of object contours and comparison with user-specific limit values
- Output of measured values and deviations on the sensor display



PHYTEC PRODUCTS AND SERVICES

- Use of standard camera module VM-010-BW-LVDS
- Use of the controller module phyCORE-i.MX 6 Quad Core
- Consulting and support by PHYTEC in the development and series production phase



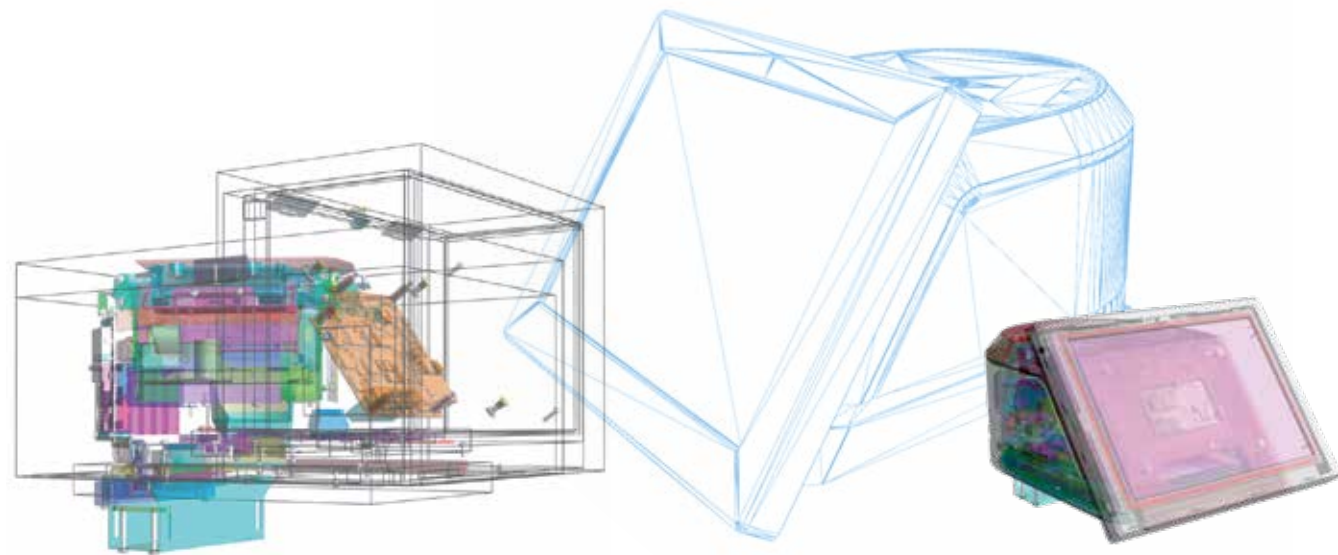

The Embedded Imaging Concept Advance performance optimally tailored to your application

Embedded Imaging – Optimized for Series Production

With our preliminary work, you can integrate cameras as easily as sensors. This "add-in" instead of "add-on" significantly increases the synergies within the application and, therefore, the cost efficiency of series products. Simplify solutions and add new functionality to your application.

Taking into account series costs and long-term availability, embedded systems offer convincing advantages.

PHYTEC System Solutions – a Perfect Fit to your Application

With PHYTEC's phyCAM concept, the requirements of a compact, tailor-made system solution can be easily met. The standardized phyCAM interfaces enable the assembly of scalable microcontroller modules with coordinated image processing components. The result is a complete system that is optimally adapted to the application.

Individualization – The Key to the Series

In addition to image acquisition, other functions (motor control, GPS, audio, CAN or I/O lines, etc.) are required. Furthermore, the hardware must be adapted to given mechanical dimensions. The application-specific base board covers these requirements perfectly. This individualization option is a very important part of our concept and distinguishes it from conventional, prefabricated components.

Interface to Software

In the phyCAM concept, software representation of the hardware is already prepared at operating system level. The required drivers for the camera sensor and controller's camera interface are integrated in our BSPs. Under Embedded Linux, the V4L2 interface is the preferred interface to the application software.

Develop Application Software Easily

The phyCAM interface makes image data available to the application software in a simple way. Further processing of the data can be implemented quickly and efficiently by using various ready-to-use image processing libraries.

Lifecycle Management

Our Lifecycle Strategies enable product maintenance and ensure the ability to deliver throughout the product life cycle. This includes obsolescence management as well as update- and security concepts.



phyCAM®-M

MIPI CSI-2 for Professional Applications

Modern processor architectures use the MIPI CSI-2 interface to connect board-level cameras. PHYTEC's phyCAM-M interface adapts this interface for professional application environments. It takes into account industrial design criteria such as interchangeability and flexibility in cable routing. Due to the optional switchable supply voltages 3.3V / 5V, the interface is open-platform and can be easily adapted if required.

The BSPs of our qualified processor modules contain the appropriate Video 4 Linux drivers ready for use.

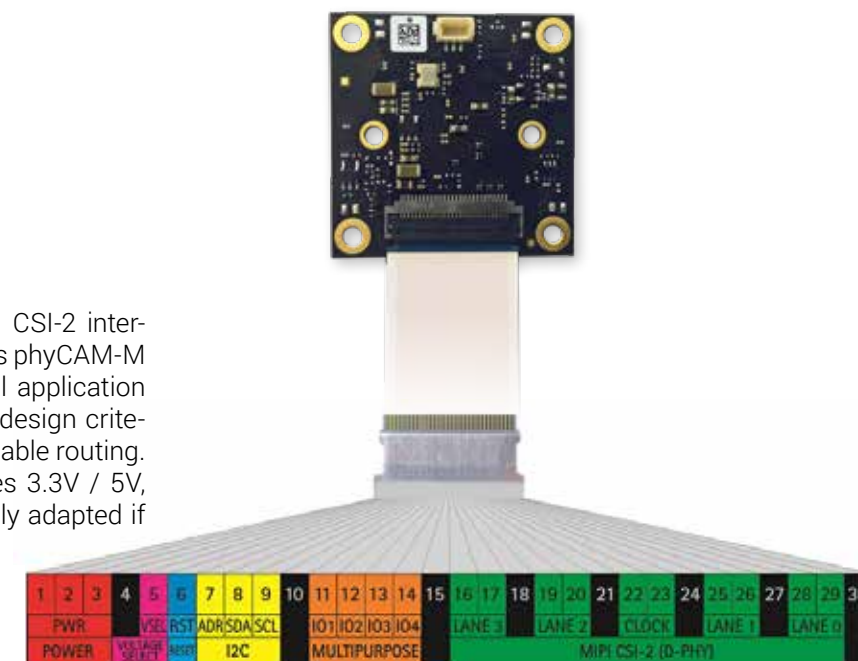

Design for High Demands

The phyCAM-M interface uses a robust and compact FFC / FPC connector type Hirose FH41 / FH48 with 30 pins. In addition to the MIPI CSI-2 interface for the image data, it carries the power supply, an I²C interface, and four multipurpose I/O pins for fast signals such as trigger and strobe. The connector is compatible with low-cost standard flex-foil cables and with freely formable FPC printed circuit boards. So any design goal can be achieved.

During design, emphasis was placed on very good EMI characteristics and high signal integrity. This is ensured by dedicated shield contacts and a tuned impedance management.

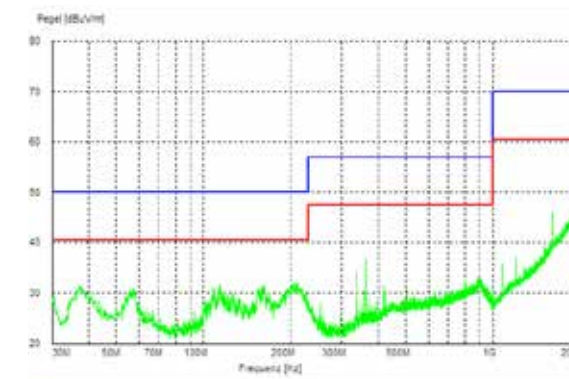

EMI Radiation EN 55011, Class B
PHYTEC i.MX8 M Reference Design phyBOARD-Polaris with VM-017 5.1 MPixels camera module, 15 cm cable

phyCAM®-L

Does it have to be longer?

The MIPI CSI-2 interface is typically limited to a free line length of approx. 15 cm. If a larger distance between camera and processor board is required, this can be easily solved by using the phyCAM-L camera series. PhyCAM-L transmits MIPI CSI-2 transparently over a coaxial cable up to 15 m long.

→ More information p. 14

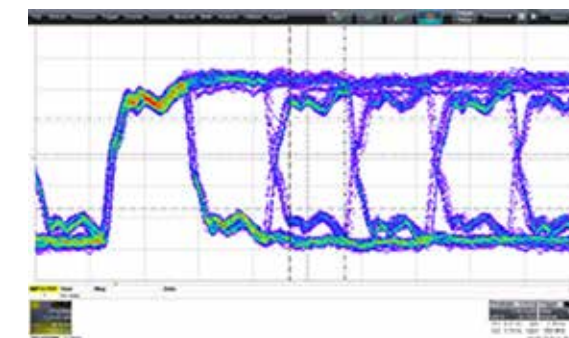

MIPI CSI-2 Signal Integrity
PHYTEC i.MX6 Reference Design phyBOARD-Nunki with VM-017 5.1 MPixels camera module, 15 cm cable

phyCAM®-M-mini

VM-116 / VM-117 / VM-120

Extremely small board-level cameras with MIPI CSI-2 interface

YOUR BENEFITS

- Only 18 mm x 26 mm size
- Monochrome or Color Sensor
- Suitable for industry for professional series use
- -25°C to +85°C
- MIPI CSI-2-Standard
- EMI optimized phyCAM-M-Interface
- Exchangeable, long-term available camera modules

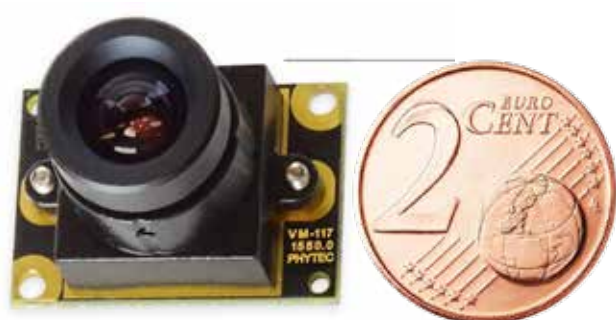

phyCAM-M-mini Smallest Board-Level-Camera with S-Mount



OUTSTANDING IMAGE QUALITY

The mini camera series models are characterized by a particularly small design. The 18 mm x 26 mm camera modules are practically identical in function to their "big brothers". The board-level cameras have modern CMOS sensors and are available in either color or monochrome versions. The new VM-120 extends the product range with a 2 MPixel module with a global shutter.

The standard phyCAM series, with a fixed size of 34 mm x 34 mm, provides mechanical interchangeability with the other models in the phyCAM series and is available with either S-mount (M12) or C/CS-mount lens holders. In contrast, the mini-series focuses on the most compact design possible for S-mount lenses.

All camera modules are electrically compatible through the phyCAM-M interface and can be immediately connected to all PHYTEC boards with MIPI CSI-2 camera interface. During the development of the mini-series, special attention was paid to mechanical properties due to the compact design.

In addition to two full-size mounting holes, two centering holes ensure easy and accurate mounting. Optimal heat dissipation is provided by support surfaces on the front, which in the S-mount version also uses the metallic holder for dissipation. As with all phyCAM models, PHYTEC supplies the appropriate driver software in our development kit BSPs, immediately ready for use. The lens assembly service enables the customer to receive their camera module fully assembled.



MAIN CHARACTERISTICS

	VM-117	VM-116	VM-120
Resolution	2592 x 1944 (5 MP)	1280 x 800 (1 MP)	1920 x 1200 (2.3 MP)
Color/Monochrome	-COL / -BW	-COL / -BW	-COL / -BW
Color Format (-COL/-BW)	Bayer Pattern / Y	Bayer Pattern / Y	Bayer Pattern / Y
Interface	phyCAM-M (MIPI CSI-2)	phyCAM-M (MIPI CSI-2)	phyCAM-M (MIPI CSI-2)
Image Sensor (-COL/-BW)	AR0521	AR0144	AR0234
Sensor Size	1/2.5" 5.7 mm x 4.3 mm	1/4" 3.84 mm x 2.4 mm	1/2.6" 5.76 mm x 3.6 mm
Pixel Size	2.2 µm x 2.2 µm	3 µm x 3 µm	3 µm x 3 µm
Shutter Type	Rolling	Global	Global
Frame Rate (full-size image)	60 fps (max.)	60 fps	120 fps
Frame Rate (Standard Video)	120 fps (Full HD)	66 fps (HD)	134 fps (Full HD)
Dynamic Range	40 dB	71.4 dB	71.4 dB
Features (optional)	Strobe/Trigger/EEPROM	Strobe/Trigger/EEPROM	Strobe/Trigger/EEPROM
Operating Voltage	3.3 V DC	3.3 V DC	3.3 V DC
Connector Type (Signal)	FFC/FPC 30 pin, 0.5 mm pitch	FFC/FPC 30 pin, 0.5 mm pitch	FFC/FPC 30 pin, 0.5 mm pitch
Operating Temperature	-25°C...+85°C (Junction)	-25°C...+85°C (Junction)	-25°C...+85°C (Junction)
Lens Mount	plain sensor / M12	plain sensor / M12	plain sensor / M12
Lens	optional, customizable	optional, customizable	optional, customizable
PCB Dimensions	18 mm x 26 mm	18 mm x 26 mm	18 mm x 26 mm

MORE CHARACTERISTICS

	VM-117	VM-116	VM-120
Sensor Technology	CMOS, Backside Illumination	CMOS, Backside Illumination	CMOS, Superior Low-light
Sensitivity	18.8 ke-/lux*sec (COL) 36.0 ke-/lux*sec (BW)	22.3 ke-/lux*sec (COL) 56.0 ke-/lux*sec (BW)	22.3 ke-/lux*sec (COL) 56.0 ke-/lux*sec (BW)
Chief Ray Angle	9°	0°	0°
ROI	yes	yes	yes
Skipping	2 / 3 / 4	2 / 4 / 8 / 16	2 / 4 / 8 / 16
Binning	yes	yes	yes
Mirror / Flip	yes	yes	yes
Defective Pixel Correction	yes	yes	yes
Control Interface	I²C	I²C	I²C
Interface Data Width	8/10/12 Bit	8/10/12 Bit	8/10 Bit
Special Feature	interleaved HDR	AEC / AGC, auto / manual	AEC / AGC, auto / manual
Mounting Points	2 x M2	2 x M2	2 x M2

phyCAM-M-mini VM-117

→ To product page



phyCAM-M-mini VM-116

→ To product page



phyCAM-M-mini VM-120

→ To product page



NEW

Cost-effective Camera Modules for Professional Imaging Solutions

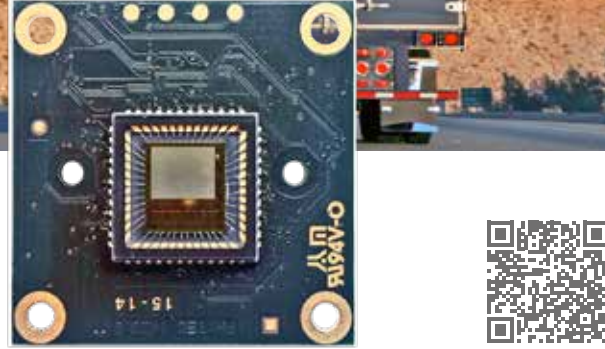

Global Shutter Camera Modules

VM-016 / VM-116 / VM-020 / VM-120

For applications where exposure must be exactly simultaneous for all pixels of the sensor, PHYTEC offers camera modules with a global shutter.

Shutter Technologies and Differences

With the cost-effective rolling shutter technology, the individual lines of the image sensor are exposed one after the other from top to bottom. Fast moving objects can consequently be imaged distorted. In camera sensors with global shutter technology, all pixels are exposed at exactly the same time. There is no distortion of moving objects. For metrological applications with fast moving objects, global shutter sensors are therefore preferable. PHYTEC has developed three phyCAM camera modules with global shutter sensors for use in series production, which are characterized by a particularly good price-performance ratio.

Ready to use for High Demands

With the VM-016, VM-116 and the new VM-020, VM-120 board cameras, the system developer has powerful CMOS image sensors with global shutter for direct use in series production. The sensors are also characterized by good sensitivity in close infrared. The camera modules can be configured in different variants and ordered ready to use with M12 or C/CS mount lens holders.



Rolling / Global Shutter: Shot of a rotating fan with different shutter technology.

Image Resolution	1280 x 800 (1 MPixel) Standard-Size				1280 x 800 (1MP) Mini	1920 x 1200 (2.3 MPixel) Standard-Size	1920 x 1200 (2.3 MPixel) Mini	
Color / Monochrome	-COL / -BW				-COL / -BW	-COL / -BW	-COL / -BW	
Image Sensor (-COL/-BW)	AR0144				AR0144	AR0234	AR0234	
Color Format (-COL/-BW)	Bayer Pattern / Y				Bayer Pattern / Y	Bayer Pattern / Y	Bayer Pattern / Y	
Optical Format	1/4" 3.83 mm x 2.4 mm				1/4" 3.83 x 2.4 mm	1/2.6" 5.76 x 3.6 mm	1/2.6" 5.76 x 3.6 mm	
Pixel Size	3 µm x 3 µm				3 µm x 3 µm	3 µm x 3 µm	3 µm x 3 µm	
Dynamic Range	71.4 dB				71.4 dB	71.4 dB	71.4 dB	
High Dynamic Range	-				-	-	-	
PCB Dimensions	Global				Global	Global	Global	
Shutter Type	34 mm x 34 mm				18 mm x 26 mm	34 mm x 34 mm	18 mm x 26 mm	
Features (optional)	Strobe / Trigger / EEPROM				Strobe / Trigger	Strobe / Trigger / EEPROM	Strobe / Trigger / EEPROM	
Operating Temperature	-25°C...+85°C				-25°C...+85°C	-25°C...+85°C	-25°C...+85°C	
Interface	phyCAM-M	phyCAM-L	phyCAM-P	phyCAM-S	phyCAM-M	phyCAM-M	phyCAM-L	phyCAM-M
Transmission protocol	MIPI CSI-2	FPD-Link III	parallel	LVDS	MIPI CSI-2	MIPI CSI-2	FPD-III Link	MIPI CSI-2
Frame rate (Full-Size)	60 fps	60 fps	60 fps	60 fps	60 fps	120 fps (max.)	120 fps (max.)	120 fps (max.)
Frame rate (Video)	66 fps (HD)	66 fps (HD)	66 fps (HD)	66 fps (HD)	66 fps (HD)	134 fps (Full HD)	134 fps (Full HD)	134 fps (Full HD)
Article Number	VM-016-COL VM-016-BW	VM-016-COL-L VM-016-BW-L	VM-016-COL-P VM-016-BW-P	VM-016-COL-S VM-016-BW-S	VM-116-COL-M VM-116-BW-M	VM-020-C-M VM-020-M-M	VM-020-C-L VM-020-M-L	VM-120-C-M VM-120-M-M



Flexible 5 Megapixel Camera

VM-017 - MIPI CSI-2
VM-117 - MIPI CSI-2 Mini

Versatile and Adaptable for your Application

Our 5 megapixel cameras strike a balance between high demands on image quality and performance on an embedded device. The high resolutions above the Full HD standard can be variably adapted to the requirements of the applications.

Due to the industrial design and long-term available sensors, the phyCAM series is suitable for almost all areas of application. The VM-017 is characterized by an excellent low-light performance and backside illumination technology. The HDR function allows you to shoot even in difficult contrast conditions. In the BSPs of the supported phyCORE modules, the software driver for the VM-x17 is already integrated as a V4L2 driver.

EXTRACT OF THE RESOLUTION OPTIONS

Image Resolution	Name	Maximum Frame Rate in fps
		VM-017 8/10 Bit MIPI
2592 x 1944	(5 Megapixel)	60
1920 x 1080	Full HD	120
1280 x 720	HD	180
640 x 480	VGA	260

Image Resolution	2592 x 1944 (5MPix) Standard-Size	2592 x 1944 (5MPix) Mini	
Color / Monochrome	-COL / -BW	-COL / -BW	
Image Sensor (-COL/-BW)	AR0521	AR0521	
Color Format (-COL/-BW)	Bayer Pattern / Y	Bayer Pattern / Y	
Optical Format	1/2.5" 5.7 mm x 4.3 mm	1/2.5" 5.7 mm x 4.3 mm	
Pixel Size	2.2 µm x 2.2 µm	2.2 µm x 2.2 µm	
Dynamic Range	40 dB	40 dB	
Shutter Type	Rolling	Rolling	
PCB Dimensions	34 mm x 34 mm	18 mm x 26 mm	
Features (optional)	Strobe / Trigger / EEPROM	Strobe / Trigger	
Interface	phyCAM-M	phyCAM-L	phyCAM-M
Transmission protocol	MIPI CSI-2	FPD-Link III	MIPI CSI-2
Framerate (full-size image)	60 fps	60 fps	60 fps
Framerate (Standard Video)	120 fps (Full HD)	120 fps (Full HD)	120 fps (Full HD)
Article Number	VM-017-COL-M VM-017-BW-M	VM-017-COL-L VM-017-BW-L	VM-117-COL-M VM-117-BW-M



phyCAM®-M

VM-X20

2.3 MPixel MIPI CSI-2 Camera Module Full HD with Global Shutter

YOUR BENEFITS

- Monochrome or Color Sensor
- 1920 x 1200 (Full HD 1080p120)
- CMOS-Sensor AR0234
- Global Shutter 120 fps (Full frame)
- phyCAM-M - MIPI CSI-2 - Standard with industrial connectors
- -25°C to +85°C
- Exchangeable, long-term camera modules available
- Corning Liquid Lens control (optional)

With the VM-020 series, our global shutter camera modules are available with an even higher resolution of 2.3 MPixel at an extremely attractive price. They are equipped with the AR0234 CMOS sensor from onsemi. This sensor, with a global shutter, is particularly suitable for capturing fast-moving objects. A frame rate of 134 in Full HD format enables detailed capture of fast-moving events. It has integrated Auto Exposure (AEC) and Auto Black Level Calibration (ABLC).

The wide temperature range and long-term availability enable the design of professional embedded vision solutions.

The VM-x20 series is available in a standard size, as a mini variant, and with phyCAM-L interface.

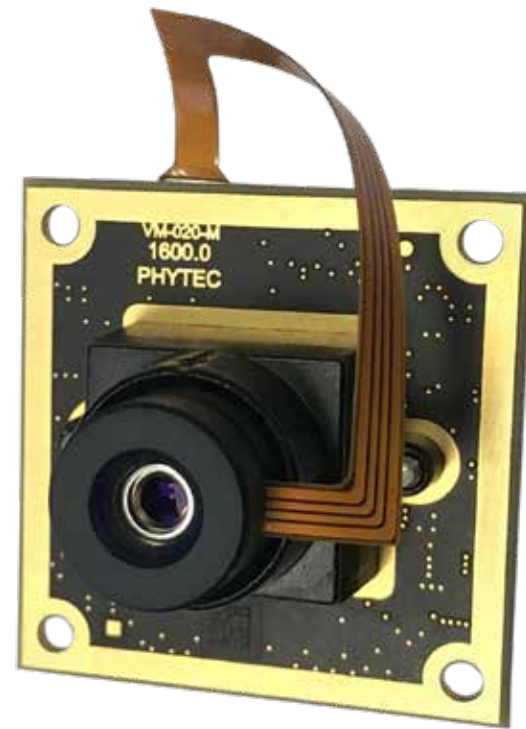

Integrate Autofocus Easily

The VM-020 module design is optionally available with a Corning Liquid Lenses driver. The lens focus can then be adjusted by software via the I²C interface. With a corresponding algorithm, an autofocus function can be realized.

→ Technical data see pages 9, 10 and 15

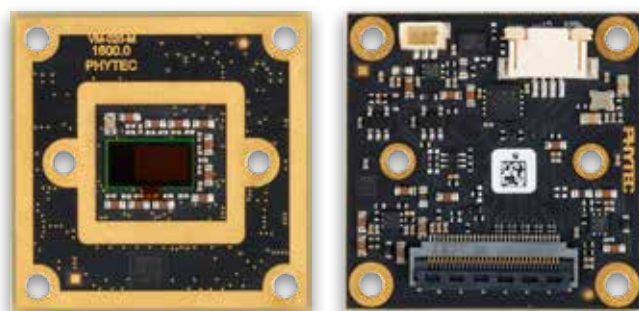

Learn More:
<https://www.phytec.eu/en/unternehmen/publikationen/>

Made in Germany Production at the highest level

PHYTEC sees itself as a supplier for serial products. Our standard products and the individual hardware for your project are manufactured in Germany, in our own production facility in Mainz. This guarantees the highest quality and flexibility with regard to your production and delivery requirements. Fast availability of prototypes and scalable services such as design and production according to industry-specific standards, e.g. VDA2 or KTA1401, are possible due to the close integration of development and production.

In an increasingly difficult component market, our obsolescence management takes over the product maintenance of your hardware, manages product change notifications of the component manufacturers and develops solutions to ensure delivery capability at all times.



YOUR BENEFITS

- PHYTEC is your partner for the entire development and delivery cycle
- We take responsibility for your project and deliver complete solutions from proof of concept to series production
- Our project managers and developers develop your product realization in partnership with you
- Individual hardware at manageable development costs
- Earlier on the market through fast prototype production, longer on the market through PHYTEC's product care



phyCAM®-L

VM-016 / VM-017 / VM-020

Board-Level Cameras with FPD-Link III Interface und Mini-Coaxial Jack

YOUR BENEFITS

- Monochrome or Color Sensor
- Signalübertragung up to 15 m
- A coaxial cable for data and power supply
- Single-board camera for industrial series production
- FPD-Link III / V³Link-Transmission
- Optimized for internal and external device use
- Easy connection to MIPI CSI-2 receiver

Experience New Ranges

With the new phyCAM-L camera interface, PHY-TEC solves the problem of the length limitation of the MIPI CSI-2 interface. While MIPI CSI-2 allows a maximum of approx. 15 cm between camera module and processor board, phyCAM-L allows up to 15 m to be bridged. By using subminiature connectors, phyCAM-L is very compact and cost-effective as a single-board module. The flexible coaxial cable functions simultaneously as a data channel and power supply. No additional cable is required. Data is transmitted using the FPD-Link III protocol, which has been tried and tested in the automotive sector, or optionally using the industrial variant V³Link. The camera modules even offer a plug-in connection for extensions.

A special feature of phyCAM-L is that the system is also particularly well suited for device-internal cabling. This can be done with a millimeter-thin, cost-effective RG1.37 cable. External connections can be customized to the task at hand using pigtail adapters. A kit with a phyCAM receiver board is available for development, which can be connected to all processor boards using a phyCAM-M MIPI CSI-2 interface.

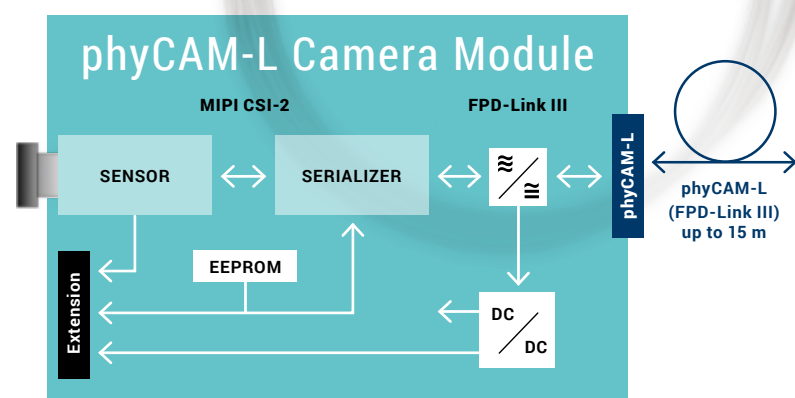
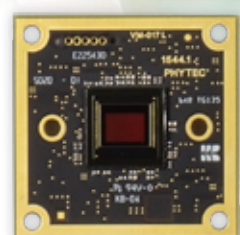

phyCAM®-L-mini

Backplane Solution for Ultra-small Sizes



NEW

The phyCAM-L-mini backplane combines the extremely small size of the phyCAM-mini cameras with the phyCAM-L solution for long camera cables. It is the ideal solution when the application requires a small camera footprint with a remote camera position.

The backplane is simply screwed behind any phyCAM-M-mini camera board and connected to it via the integrated phyCAM-M pigtail. The functionality corresponds to that of the phyCAM-L standard model – with extremely compact dimensions of typ. 18 x 26 mm and a depth of less than 15 mm (plus lens).

Just like its "big brother", phyCAM-L-mini also has an expansion interface which provides power supply, I²C interface as well as strobe and shutter signals from the camera sensor.

Of course, phyCAM-L-mini camera modules are also available with the lens of your choice.

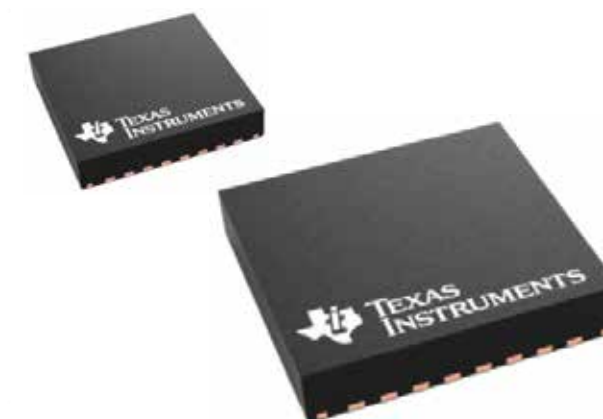

FPD-Link III or V³Link?

All phyCAM-L products are available with either FPD-Link III or V³Link interface. Both are interface systems from Texas Instruments and are compatible with each other. While FPD-Link III is designed for the automotive market, V³Link is designed for industrial applications.

WHICH SYSTEM SHOULD BE CHOSEN FOR A PARTICULAR APPLICATION?

The following table provides an overview of the main differences:

Parameter*	FPD-Link III™	V³Link™
Data Rate	4.16 Gbps	4.16 Gbps
Target Market	Automotive	Industrial
Operating Temp.	-40...+105 °C	-20...+85 °C
Functional Safety	AEC-Q100	-
Cost	€€€€€	€€€€€€

*) Selected features and model variations. In critical application environments, we recommend that you refer to the chip manufacturer's datasheets. Note: In this catalog we use FPD-Link III synonymously for both systems. All phyCAM-L products are available as FPD-Link III or V³Link versions.



phyCAM[®]-L Starter Kits

FPD-Link III Starter Kits

phyCAM-L Board-Level Camera
incl. Converter to phyCAM-M
(MIPI CSI-2) interface

YOUR BENEFITS

- Starter Kit for easy implementation of phyCAM-L solutions
- FPD-Link III Standard
- Creation of a transparent MIPI CSI-2 channel
- Connection to all imaging boards with phyCAM-M input
- Up to 15 m coaxial cable length (Power-over-Coax)
- Kit contents: Camera module with FPD-Link III interface, VZ-018: FPD-Link III converter board phyCAM-L/ M with phyCAM-M output (MIPI CSI-2), reference schematics, accessories
- Simply combine with desired Embedded Imaging Kit

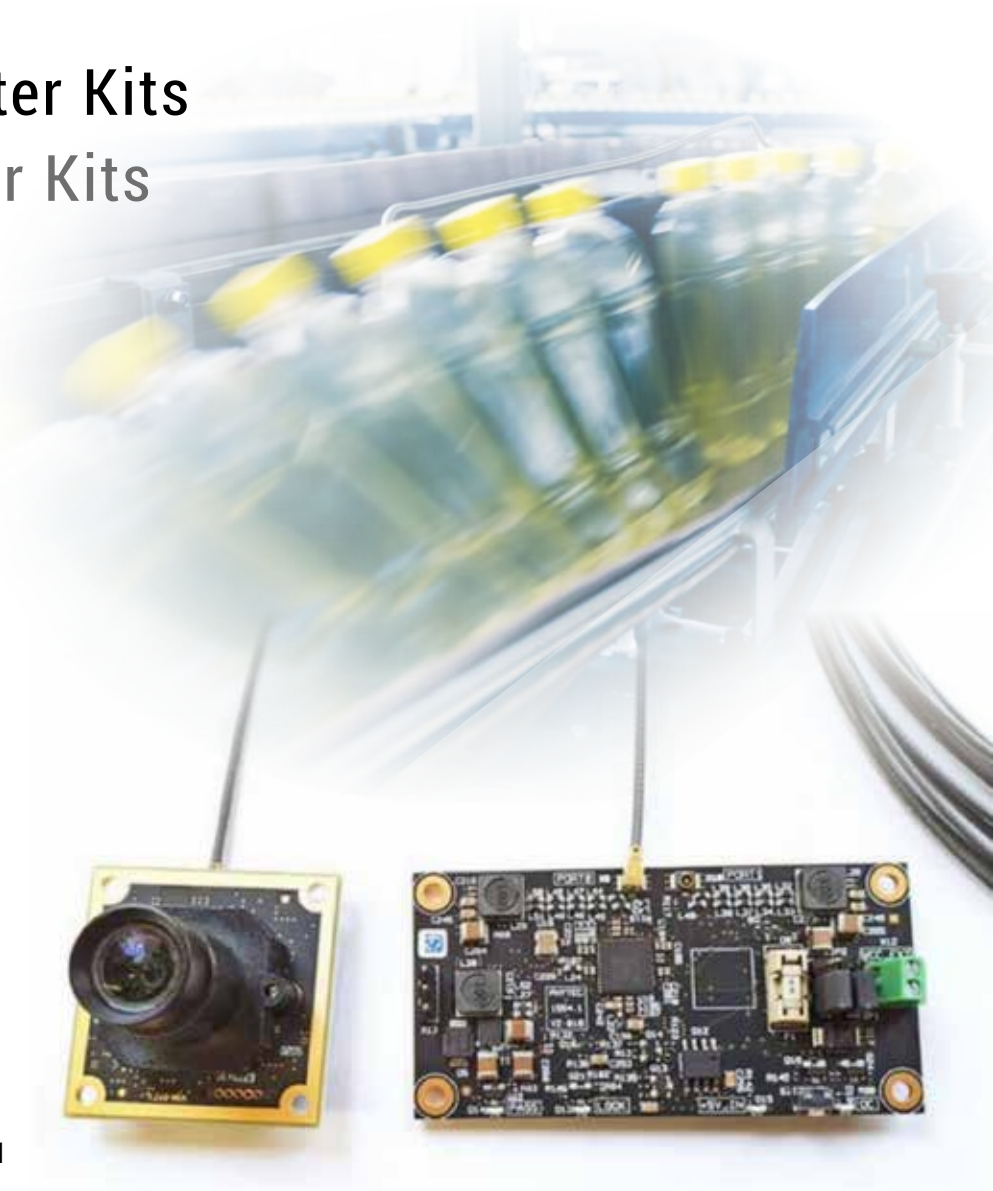

THIS IS HOW EFFICIENCY WORKS

The kits allow the phyCAM-L board-level cameras to be commissioned on any compatible embedded imaging kit. The phyCAM-L interface connects the camera module and converter board via a single coaxial cable of up to 15 m length. Power-over-coax eliminates the need for an additional power supply cable.

On the receiver side, the VZ-018 converter board provides conversion to MIPI CSI-2 and can be easily connected to a compatible embedded imaging kit via the phyCAM-M interface.

The FPD-Link III based phyCAM-L interface is transparent for data transfer. After initialization of the transmission path, the camera driver already integrated in the BSP can be used for the camera modules.

The converter board has two phyCAM-L inputs. Two camera modules can be connected to the phyCAM-M output. The power supply for the camera module can be provided directly from the computer board via the phyCAM-M interface or, if required, can be supplied externally at the converter board.

The kit contains a highly flexible coaxial cable of type RG1.37, which is particularly suitable for internal device wiring. It can be connected directly to the UMCC Gen.1 sockets of the camera module and converter board. Other cable types (e.g. RG174) can be used via pigtail adapters (accessories). Adapters are available e.g. with SMA or FAKRA connectors.

For serial use, the converter circuit is usually integrated on the base board. The necessary information and reference schematics are included in the kit.

STARTER KITS

- VM-016-L FPD-Link III Starter Kit
- VM-017-L FPD-Link III Starter Kit
- VM-020-L FPD-Link III Starter Kit

MATCHING EMBEDDED IMAGING KITS

- phyBOARD-Pollux Imaging Kit
- phyBOARD-Polaris Imaging Kit
- phyBOARD-Polis Imaging Kit

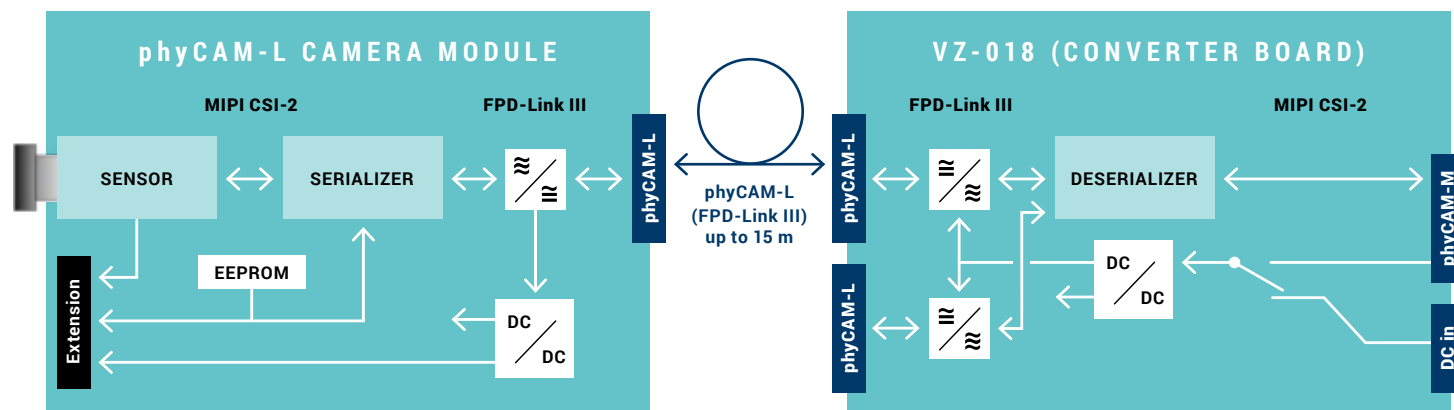

5 MPixel	1 MPixel
VM-017-L FPD-Link III Starter Kit	VM-016-L FPD-Link III Starter Kit
→ To product page	→ To product page



PHYTEC Design Service Hardware as individual as your project

YOUR BENEFITS

- **Space and cost efficient solution**
- **Interfaces and functions adapted exactly to your needs**
- **Protection of intellectual property rights**
- **Hardware from a single source – no need to manage and plug together many parts of different origin**
- **Future-proof through professional product maintenance and upgrade options**

Embedded hardware shows its advantages in series production, especially when it is perfectly adapted to the target system. The efficient means for this is the project-specific base board, which can be fully adapted to the requirements of your project.

Describe your task to us in a free project workshop or send us your specification. We will sketch your individual solution together with you and subsequently work out the specification.

By using the pre-developed components such as camera and processor module, our circuit diagram library and the experience our engineers have gained from hundreds of projects, the development of an individual hardware is more cost-effective than you might think.

Additionally, the PHYTEC project manager will accompany you from the specification to the start of production. Your specific solution, just like our standard products, is manufactured in our factory in Mainz. This enables short reaction times and the flexible fulfillment of individual requirements, including assembly and rollout service.



DIALUNOX

Customer Testimonial

DIALUNOX has been a leading developer and manufacturer of reflective and fluorescence-based detection systems in medical diagnostics for more than 20 years.

For a new generation of the OEM lateral flow reader "ESEQuant Flex", PHYTEC developed the device electronics from specification in close cooperation with DIALUNOX. By using the ready-made phyCORE-i.MX 6 and VM-011 processor and camera modules, it was possible on one hand to reduce development efforts and on the other hand to outsource essential parts of the product maintenance in series production.

"When we started the development of the ESE-Quant Flex, PHYTEC was, in retrospect, exactly the right partner for us. The development kits and support allowed us to get off to a flying start. Later in the electronics subproject, the constructive and open cooperation allowed us to bring a great product to the market in a short time. Typically, you plan several loops in a development project – here in the project with PHYTEC, everything was actually done in one go, except for small detail adjustments. I have never experienced this before in my career."

*Dr. Juha Koota
Senior System Engineer
R&D Systems Engineering and Optics,
PON Instrumentation*

Processor Modules for Embedded Imaging Ready to use for Individual Series Solutions

Our microprocessor modules represent complete computer systems (SOM – System on Module) on a ready-to-use, compact board. They are equipped with the interfaces for the digital camera modules of the phyCAM series. This allows the camera modules to be connected to the computer board easily and cost-effectively. The processor-specific camera interfaces also allow direct access to internal pre-processing units for image data.

The modules offer a variety of data interfaces: Ethernet, HDMI, CAN, I²C, TFT display and RS-485 to name but a few. They can, therefore, be easily integrated into many applications. The adaptation to the respective task is done by the individual base board, onto which the module is plugged or – in our DSC solutions – directly soldered. The base board can also contain additional function groups and sensors.

Processor functions, interfaces and phyCAM camera modules are supported by the corresponding Linux operating system (BSP) which is maintained by PHYTEC. Our development kits enable software and design verification even before the individual base board is available.

Benefit from our many years of experience: PHYTEC development engineers advise customers who wish to develop their baseboards themselves and are available for design reviews. We would also be happy to take over the entire electronic development of the base board for you.

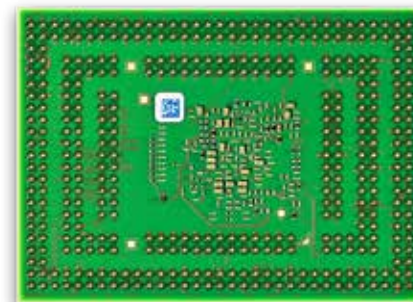

The DSC technology enables high connectivity and a low-cost connection of SOM and base board.



You can find even more information on our modules at:

www.phytec.eu

Feature	STM32MP157	i.MX 6 ULL	i.MX 8M Nano	i.MX 8M Mini	i.MX 8M Plus	AM68x
Camera Interfaces	1x parallel	1x parallel	1x MIPI CSI-2 ¹⁾	1x MIPI CSI-2 ¹⁾	2x MIPI CSI-2 ¹⁾	2x phyCAM-M
Image Pipeline	DCMI	ISI	ISI	CSI	ISI / ISP	VISS / ISP (DSP C7x)
CPU-Cores ²⁾	2x Cortex™ A7	1x Cortex™ A7	4x Cortex™ A53	4x Cortex™ A53	4x Cortex™ A53	2x Cortex™ A72
CPU Frequency	650 MHz	792 MHz	1.5 GHz	1.8 GHz	1.8 GHz	2 GHz
Realtime CPU	Cortex M4, 209 MHz	-	Cortex M7, 750 MHz	Cortex M4, 400 MHz	Cortex M7, 800 MHz	2x Cortex-R5F, 1 GHz
3D GPU	1x Vivante GC Nano	-	1x GC7000 UL	1x GC Nano Ultra	1x GC7000 UL	1x BXS-4-64
3D GFLOPS ³⁾	3.2	-	16 / 32	6.4	16 / 32	50
OpenCV/VX ⁴⁾	-	OpenCV 4.0.1	OpenCV 4.5.2	OpenCV 4.5.2	OpenCV 4.5.2	OpenCV 4.5.2
SMID-Unit	2x Arm NEON™	1x Arm NEON™	4x Arm NEON™	4x Arm NEON™	4x Arm NEON™	2x Arm NEON™
VPU ⁵⁾	-	-	-	H.265 -/D 1080p60 H.264 E/D 1080p60	H.265 E/D 1080p60 H.264 E/D 1080p60	H.265 E/D 4k60 H.264 E/D 4k60
NPU	-	-	-	-	2,3 TOPS	8 TOPS
Plattform	SARGAS	SEGIN	POLIS	POLIS	POLLUX	IZAR
phyCAM-Interface	1x phyCAM-P	1x phyCAM-P	1x phyCAM-M	1x phyCAM-M	2x phyCAM-M	2x phyCAM-M
Operating System	Linux 5.x	Linux 5.4	Linux 5.4	Linux 5.4	Linux 5.10	Linux 5.x

Selected derivatives: 1) 4-lane MIPI CSI-2 2) scalable 3) theor. values MP/HP 4) status Q3/2021 5) D=decode / E=encode, all data are preliminary

→ Further functions and interfaces of the processor modules can be found in the overview table on page 34

i.MX 8M PLUS IMAGE SIGNAL PROCESSOR Integrated Image Preprocessing

The image signal processors (ISPs) integrated in the i.MX 8M Plus can prepare the image data from the camera sensor for subsequent image processing without consuming CPU resources. An ISP, therefore, takes over many routine tasks that would otherwise be realized in software or even in a separate chip. This makes the entire image processing system more cost-effective and better performing.

It should be noted that many of these functions require calibration to the camera and / or lens used. In some cases, calibration to the specific application environment may also be necessary.



Example: Lens Distortion Correction (Dewarping)

PHYTEC ISP Calibration Service

NEW

Our board-level cameras are already pre-calibrated for use with the phyCORE i.MX 8M plus module. This means that basic ISP functions can already be used directly. PHYTEC offers an individual calibration service for your application so that you can benefit optimally from the ISP functions of

the i.MX 8M plus in your application. As a result, you receive a calibration file for the phyCORE-i.MX 8M Plus-BSP for your specific combination of board-level camera, lens, and application parameters, which makes the desired ISP functions usable in your application.

These functions are already included in the BSP of the phyCORE i.MX 8M Plus module as basic calibration for the phyCAM modules VM-016, VM-116, VM-017, VM-117:

Demosaic	• Conversion of the sensor's raw color data into RGB values
Denoise/Sharpen Filter	• Visual improvement of the image quality
AEC (Auto Exposure Control)	• Automatic exposure control (basic calibration)
AWB (Auto White Balance)	• Automatic white balance (for color cameras, basic calibration)
BLC (Black Level Correction)	• Black level adjustment (for cameras without internal BLC)
Defect Pixel Cluster Correction	• Automatic correction of defect pixels (for cameras without internal DPC)
WDR3 (Wide Dynamic Range)	• Contrast enhancement in difficult lighting conditions



ISP-CALIBRATION PACKAGE

In the calibration package, we offer you the basic calibration of your individual camera-lens combination at a fixed price. The calibration is based on a phyCAM camera and a lens from our portfolio, taking into account project-specific parameters.

As a result, you will receive calibration files that you only need to install in the BSP of the phyCORE-i.MX 8M Plus module.

These functions are included in the Optics 1 calibration package:

Dewarp	• Lens Distortion Correction ("fisheye effect")
Lens Shade Correction	• Correction of lens edge shading
CPROC	• Optional fixed-value tuning of brightness, contrast, saturation and HUE

Optics 1 Package Price
1350.- € *

We will be happy to advise you individually on ISP calibration:

<https://www.phytec.eu/en/unternehmen/kontakt/embedded-imaging/?lang=en/>

*) Prerequisites and detailed scope of services are available upon request.



phyCORE®-i.MX 8M Plus

ARM Cortex™-A53/-M7

The "smartest" i.MX 8 module

YOUR BENEFITS

- **Neural Processing Unit**
- **2x Image Signal Processor + 2x MIPI CSI-2**
- **HiFi 4 Audio DSP**
- **2x LVDS, MIPI DSI-2, HDMI**
- **Real-time with Cortex-M7**
- **2x GB Ethernet (1x with TSN)**
- **2x CAN FD, 2x USB 3.0**
- **High reliability (DRAM inline ECC, ECC on on-chip RAM)**
- **Scalable plug-in module (60 pin connector optional) or FTGA (Fused Tin Grid Array) solder module**



Based on the NXP i.MX 8M Plus SoC, the phyCORE-i.MX 8M Plus is the "smartest" PHYTEC module. Equipped with up to 4 Cortex-A53, one Cortex-M7 for real-time applications, and a unique combination of a variety of multimedia interfaces with a powerful NPU (Neural Processing Unit) and the integrated image signal processors (ISPs), the i.MX 8M Plus SoC is ideally suited for machine learning (ML), image processing, advanced multimedia, and industrial IoT applications.

The scalable and size-optimized phyCORE-i.MX 8M Plus is the perfect basis for using all the i.MX 8M Plus features in areas where intelligent and fast processing of multimedia data in a small space is required. Be it in the Smart Home (e.g. home automation), the Smart City (e.g. people/traffic monitoring), Industry 4.0 (e.g. intelligent robot control, HMI) or IIoT applications (e.g. edge computing).

phyCORE-i.MX 8M Plus

→ To product page

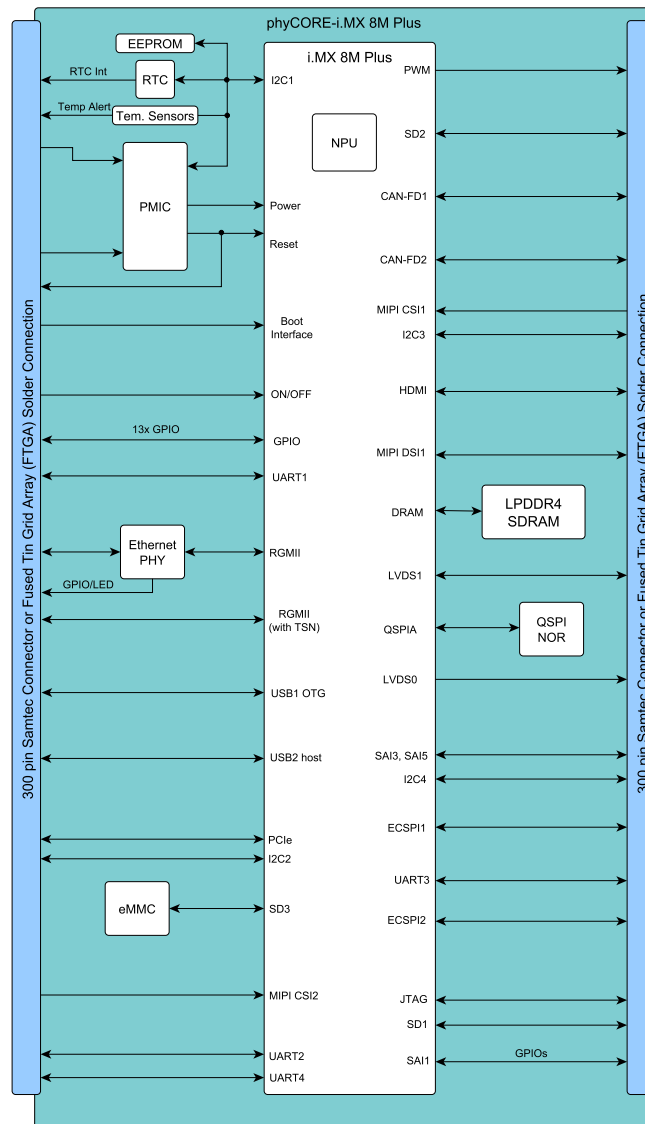

phyBOARD®-Pollux

NXP i.MX 8M Plus Imaging Kit

Development kit with phyCAM-M Camera

YOUR BENEFITS

- **phyCORE-i.MX 8M Plus Processor board**
- **2 MIPI CSI-2 Inputs**
- **2 integrated image signal processors (ISP)**
- **NPU Neuronal Processing Unit**
- **Incl. global shutter HD color camera**
- **Ready to go: pre-installed Linux image with integrated V4L2 camera driver**
- **Two independent phyCAM-M MIPI CSI-2 camera interfaces**
- **Hardware Video Encoder/Decoder (H.264/H.265)**
- **Connectivity: Gigabit Ethernet, 2x USB 3.0, miniPCIe**

Premier League Embedded Vision

The phyCORE-i.MX 8M Plus board opens up a new performance class for embedded vision applications:

- The integrated Image Signal Processors (ISP) process the camera image data independently of the CPU. Bayer demosaicing of high-resolution live streams is possible in real-time without CPU load.
- Two independent camera interfaces for MIPI CSI-2 camera modules of the latest generation. Due to the standardized phyCAM-M connectors on the base board, different camera boards can be connected easily.
- The 1.6 GHz Quad Cortex-A53 NXP processor with an M7 real-time co-processor enables the creation of completely new and powerful image processing systems.
- The advanced video encoder and decoder can also process H.265 formats in both directions.

phyBOARD-Pollux Imaging Kit

→ To product page



AI Edge Computing

The first module with integrated neural co-processor drastically accelerates AI and machine learning processing. The NPU unit with 2.3 TOPS can accelerate the processing of neural networks by a factor of 20. Even more complex tasks can be computed on the module without having to process the data in the cloud. The NPU is integrated in the BSP via Tensor-Flow Lite.

Exceptional Connectivity

The phyBOARD-Pollux integrates the greatest possible variety of interfaces: in addition to the two phyCAM-M interfaces, the board is equipped with 2x USB 3.0, 2x CAN FD, 2x Gigabit Ethernet, miniPCIe, LVDS display, MIPI DSI, HDMI, audio and digital I/Os.

Better Integrated – Faster in Series

The kit is based on the production-ready components phyCORE-i.MX 8M Plus and phyCAM VM-016-M camera module. You develop with exactly the components that will later be used in your series device. This makes the transfer to series production particularly easy and safe.

Use our support, our enclosed reference circuit diagrams and our advance services for your designs or create your design together with us.

The Embedded Imaging Kit Pollux can also be delivered with other hardware configurations (e.g. with other camera modules of the phyCAM-M series). Let us put together your individual desired kit for you.

phyCORE®-i.MX 8M Mini/Nano

ARM Cortex™-A53/-M4

Efficient computing power on only 40 mm x 37 mm

YOUR BENEFITS

- Scalable performance i.MX 8M Mini SoloLite to Quad
- Cortex-M4 for real-time applications
- MIPI-DSI to FlatLink converter
- Optimal EMI and EMC properties
- FTGA soldering technology
- Resistance to shock and vibration
- 1080p Video Encoding/Decoding
- 2D/3D Graphics acceleration
- MIPI CSI-2
- Multi-channel Audio
- Pin compatible with i.MX 8M Nano processor

Multimedia-Encoder – Video, Grahic, Audio

The i.MX 8M Mini encodes video and converts camera raw data into a transferable format. i.MX 8M Mini is the performance-oriented multimedia professional, i.MX 8M Nano has slimmer multimedia features and is more cost-effective.

Scalable Performance Across the i.MX 8 Family

PHYTEC maintains the same SW infrastructure under Yocto for all derivatives of the entire i.MX 8 family.

Hard Real-Time and Convenient Application

The Cortex-A53 processor comfortably handles application tasks with the support of an operating system. The Cortex-M4 controller handles deterministic tasks with real-time requirements.

High Performance with Low Power Consumption

Simpler heat dissipation designs due to favorable Mips per Watt ratio of Advanced 14LPC FinFET Process technology.

[phyCORE-i.MX 8M Mini/Nano](#)

→ To product page

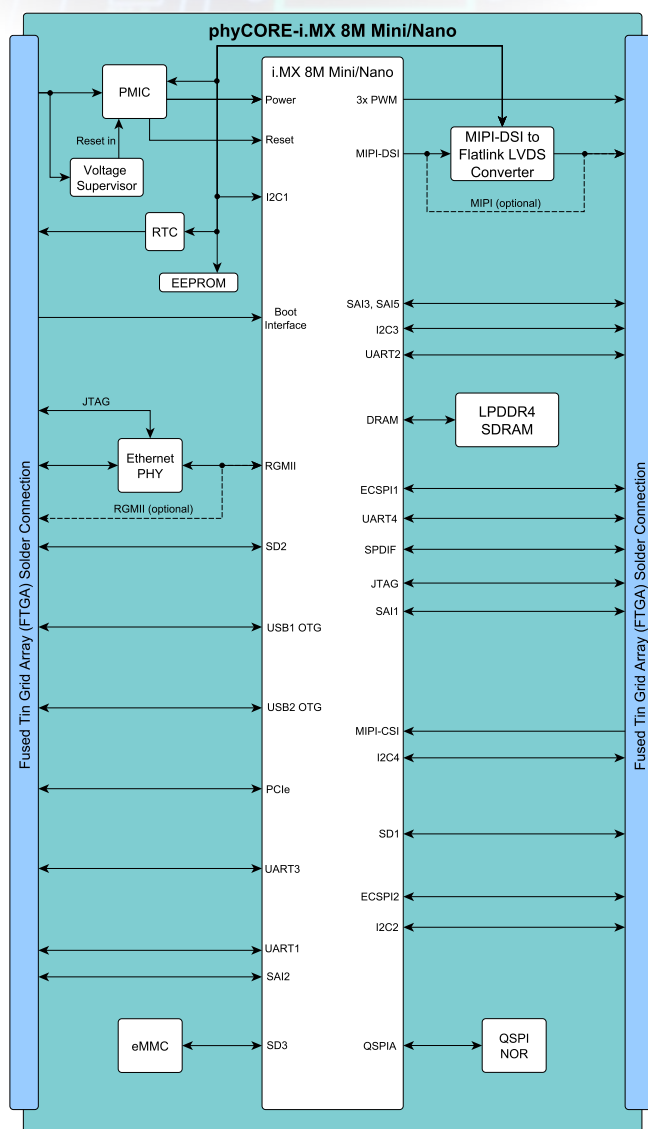

phyBOARD®-Polis

NXP i.MX 8M Mini Imaging Kit

Development Kit with phyCAM-M camera



YOUR BENEFITS

- phyCORE-i.MX 8M Mini Processor board
- 4-lane MIPI CSI-2 Iput (phyCAM-M)
- Integrated H.264 Encoder/Decoder
- Incl. 1 MPixel Global Shutter HD-color camera
- Incl. 10" Display incl. capacitive touch
- Ready to go: pre-installed Linux image with integrated V4L2 camera driver
- i.MX 8M Mini-Processor with 4 x Cortex-A53 Cores and 1 x Cortex-M4
- WiFi/BLE4.2 onboard
- Hardware Video Encoder/Decoder Hantro (H.264/H.265) 1080p60
- Connectivity: Gigabit-Ethernet, 2 x USB 2.0, miniPCle

Embedded vision made easy

The phyCORE-i.MX 8M Mini Board is particularly suitable for simple and cost-effective embedded vision applications. Compared to the vision all-rounder i.MX 8M plus, emphasis was placed here on the most important entry-level components of an image processing system:

- A camera interface for MIPI CSI-2 camera modules of the latest generation. The standardized phyCAM-M connector on the baseboard makes it easy to connect different camera boards.
- Direct image data transfer from the CSI interface to the system bus and provision for processing in the CPU and GPU.

[phyBOARD-Polis Imaging Kit](#)

→ To product page



- H.264 Video-Encoder and H.264/H.265 Decoder with 1080p60.
- 1,6 GHz Quad Cortex-A53 NXP processor with an M4 real-time co-processor allows building simple yet powerful image processing systems.

Better integrated – Faster in series

The kit is based on the production-ready components phyCORE i.MX 8M Mini and the phyCAM VM-016-M board-level camera. You develop with exactly the components that will later be used in your series device. This makes the transfer to series production particularly easy and safe. Take advantage of our support, our enclosed reference schematics and our advance services for your designs or create your design together with us. The Embedded Imaging Kit Polis can also be delivered with other hardware configurations (e.g. with other camera modules of the phyCAM-M series). Let us put together your individual desired kit for you.

phyCORE®-STM32MP157

ARM Cortex™-A7/-M4

SOM with parallel camera interface

YOUR BENEFITS

- Dual-Core Arm Cortex-A7 CPU with Cortex-M4 Subsystem
- Parallel camera interface, 10-bit
- 3D graphics processing with Vivante – OpenGL ES 2.0
- Enhanced hardware encryption and secure boot
- SLC NAND or eMMC
- Gigabit Ethernet, 2x USB 2.0
- Up to 2x CAN FD
- MIPI DSI-2 or parallel 18-bit Display Interface
- ADC, DAC, DFSDM

The phyCORE-STM32MP157 module is ideal for industrial communication systems, edge computing, factory automation, motor control, and applications that require high reliability. The camera interface allows these tasks to be flanked by imagery from a camera. The STM32M157 is differentiated by the parallel camera interface and its very affordable price.

The STM32MP157 microcontroller forms the foundation. Two ARM Cortex-A7 cores provide access to open-source operating systems (e.g. Linux), while a Cortex-M4 MCU subsystem uses the STM32 MCU ecosystem. This allows applications developed for an STM32 MCU to be fully reused and run independently on the Cortex-M4 core, while the Linux application, for example image processing or an HMI, runs on the Cortex-A7 cores.

The phyCORE-STM32MP157 also offers strong connectivity through a Gigabit Ethernet PHY, two USB 2.0, and up to two CAN-FD interfaces for industrial communication. The processor also supports functional security features for sensitive applications.

phyCORE-STM32MP157

→ To product page

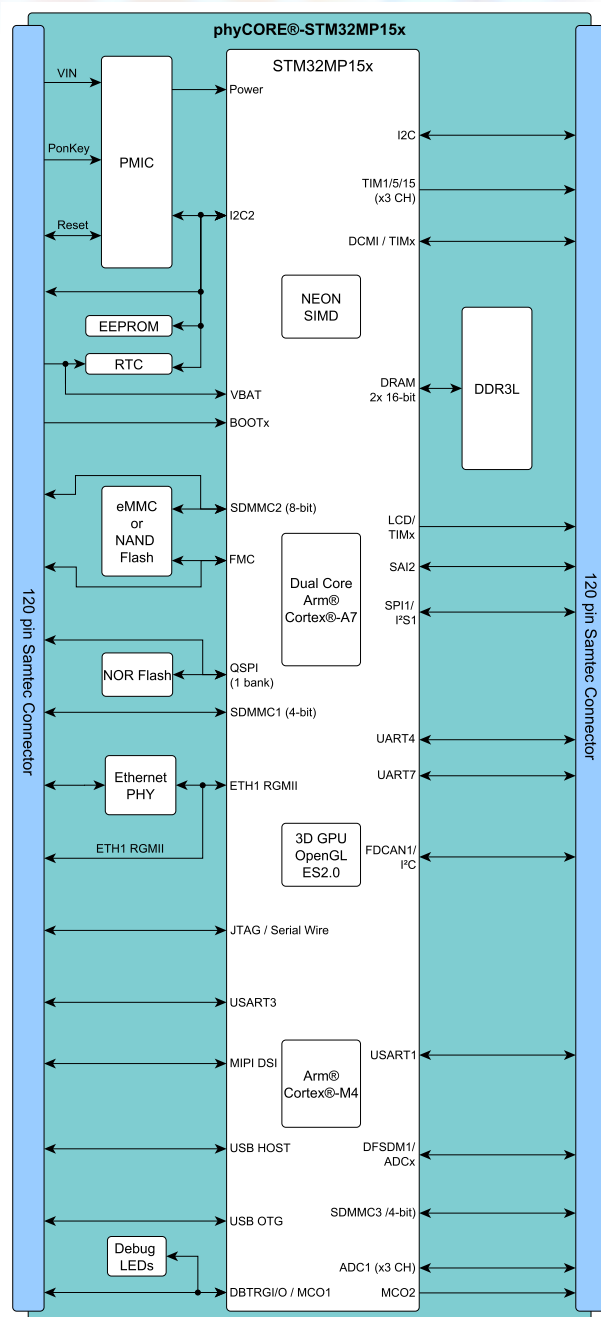

phyBOARD®-Sargas

STM32MP157 Imaging Kit

Development Kit with phyCAM-P Camera

YOUR BENEFITS

- phyCORE-STM32MP157 Baseboard
- A parallel Camera interface phyCAM-P, 10 Bit
- Incl. 1 MPixel Global Shutter HD color camera
- Incl. 7" Display with capacitive touch
- Connectivity: Gigabit-Ethernet, 2 x USB 2.0, 1x CAN FD
- Ready to go: pre-installed Linux image with integrated V4L2 camera driver

Cost-sensitive Embedded Vision System Solution

The phyCORE-STM32MP157 board is especially suited for simple and low-cost embedded vision applications. It provides an easy-to-program data path for camera images:

- A camera interface for parallel camera modules. Due to the standardized phyCAM-P connector on the base board, different camera boards can be connected directly.
- Image data transfer from the DCM1 camera interface to the system bus and provision of the data for processing in the CPU and GPU.
- 650 MHz dual-core Arm Cortex-A7 processor with an M4 real-time coprocessor
- Vivante GPU GC7000 Lite

The scope of the phyCORE-STM32M157 is in simple image processing or I&C applications, which can be complemented by simple image processing and/or HMI interfaces. The processor architecture with separate ARM Cortex A7 and M4 real-time cores allows a separation of control software and user level. In addition, the STM32 MCU ecosystem is also available to the developer. The Sargas Embedded Imaging Kit can also be delivered with other hardware configurations (e.g. with other camera modules of the phyCAM-P series). Let us put together your individually desired kit.

phyBOARD-Sargas Imaging Kit

→ To product page



phyBOARD-Sargas – The Fast Way in Series Production

Whether as a single-board computer or as a development kit – with the phyBOARD-Sargas you start directly with the hardware and software components that will be used in the final product. This makes the transfer to series production particularly safe and easy.

Our support, the enclosed reference circuit diagrams, and preliminary services facilitate the development of a customized baseboard for you. The PHYTEC design service develops your individual design according to your specification on request.

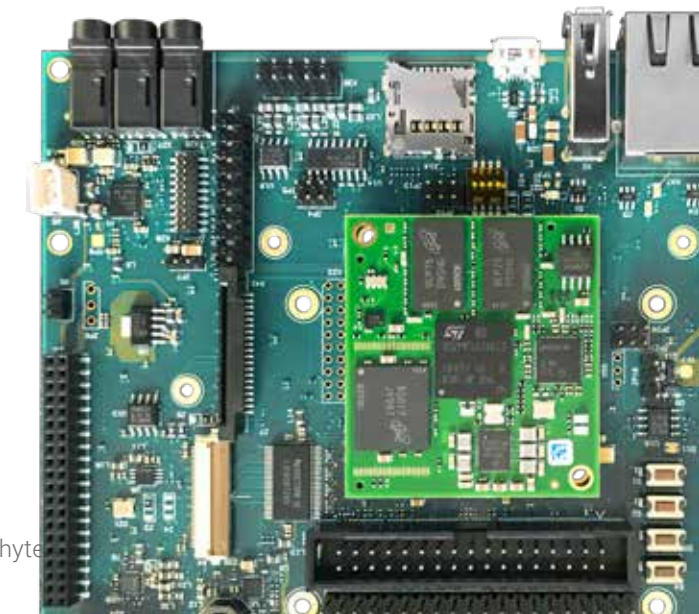



BSP and Middleware Best Ecosystem for your Application

YOUR BENEFITS

- **Professionally maintained Linux BSP**
- **Linux is open source and royalty-free**
- **Ready to use BSPs, adapted to our hardware, save you considerable time and costs**
- **Test and develop your application with our imaging kits before the target hardware is available**
- **Individual hardware adaptations by the PHYTEC development team are possible**

The application software is often the heart of your product. Our preliminary software services are the enablers for the efficient development of individual solutions across a wide range of industries and applications.

With our "Embedded Imaging" development kits, you receive free, well-maintained board support packages with Embedded Linux distributions. They contain the software drivers for our V4L2-based phyCAM camera modules.

Middleware, in the form of libraries, is also included or can be additionally installed. This includes image processing libraries such as OpenCV, Halcon Embedded, or Gstreamer. AI frameworks such as TensorFlow or solutions for over-the-air updates are also available.

Learn more:
<https://www.phytec.eu/products/software>

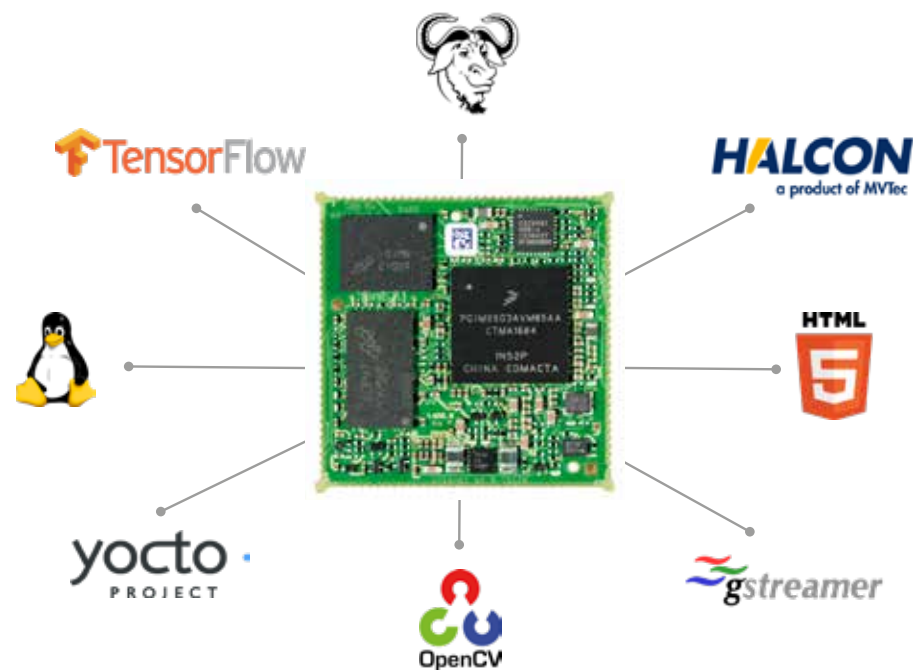

Customer Testimonial

IVU Traffic Technologies AG has been ensuring punctual and reliable traffic in the world's major cities for over 35 years. PHYTEC develops and produces devices such as on-board computers and ticket printers for IVU and takes over delivery management tasks. For the Rotterdam subway, the IVU.BOX on-board computer was equipped with a video interface for platform control.



Matthias Rust
Executive Management
IVU Traffic Technologies AG

„PHYTEC's expertise in electronics, software and mechanics complements IVU's in-house expertise perfectly.“

APPLICATION

- On-board computer for the driver control desk for the Rotterdam metro
- Integrated video interface for monitoring the vehicle entrances
- Connection of existing camera infrastructure to new on-board computers

PHYTEC PRODUCTS AND SERVICES

- Complete development of the IVU.BOX product range in close consultation with the customer
- Production and delivery management of the complete devices
- Use of ready-to-use hardware phyCARD-i.MX 6 and video decoder VM-008





YOUR BENEFITS

- Large selection of standard lenses
- Compact M12 or C/CS mount
- Low-priced, custom-made for your development
- Individual configurations (filter, iris settings)
- Complete mounting on camera module possible

Lenses Perfectly fitting optics for your project

We are happy to advise you in order to find the optimal solution for your task. Within the scope of OEM projects, we configure lenses according to your requirements. With our assembly service, we can deliver individually assembled camera modules with lens.



M12 LENSES (M12 X 0.5 / S-MOUNT)

Focal-length	Iris range	MOD	IR-cut filter	Lens mount	Angle of view (D)	Article Number	Price in EUR (plus VAT)
Suitable for sensors up to 1/3" and up to 1 MPix					at 1/4"		
1.8 mm	2.0	0.4 m	-	S-Mount**	122°	A0086	€ 18.00
1.8 mm	2.0	0.4 m	yes*	S-Mount**		A0086-C	€ 18.00
2.1 mm	2.0	0.4 m	-	S-Mount	122°	A0031-1	€ 18.00
3.94 mm	2.0	0.4 m	-	S-Mount	72°	A0065	€ 18.00
6 mm	2.0	0.4 m	-	S-Mount	46°	A0057	€ 18.00
6 mm	2.0	0.4 m	yes*	S-Mount	46°	A0057-C	€ 18.00
12 mm	2.0	0.4 m	-	S-Mount	19°	A0082	€ 20.00
12 mm	2.0	0.4 m	yes*	S-Mount	19°	A0082-C	€ 20.00
16 mm	2.0	0.4 m	-	S-Mount	21°	A0059	€ 18.00
Suitable for sensors up to 1/2.7" and up to 5 MPix***					at 1/2.7"		
0.96 mm	2.0	0.1 m	-	S-Mount	210°	A0090	€ 60.00
0.96 mm	2.0	0.1 m	yes*	S-Mount	210°	A0090-C	€ 60.00
Suitable for sensors up to 1/2.5" and up to 5 MPix					at 1/2.5"		
2.5 mm	2.4	0.1 m	-	S-Mount	166°	A0070.A1	€ 28.00
2.5 mm	2.4	0.1 m	yes*	S-Mount	166°	A0070-C.A1	€ 28.00
2.9 mm	1.6	0.1 m	-	S-Mount	152°	A0071.A1	€ 28.00
2.9 mm	1.6	0.1 m	yes*	S-Mount	152°	A0071-C.A1	€ 28.00
4.0 mm	1.8	0.4 m	-	S-Mount	112°	A0078	€ 26.00
4.0 mm	1.8	0.4 m	yes*	S-Mount	112°	A0078-C	€ 26.00
6.0 mm	1.8	0.4 m	-	S-Mount	68°	A0079	€ 26.00
6.0 mm	1.8	0.4 m	yes*	S-Mount	68°	A0079-C	€ 26.00
8.0 mm	1.8	0.55 m	-	S-Mount	52°	A0080	€ 26.00
8.0mm	1.8	0.55 m	yes*	S-Mount	52°	A0080-C	€ 26.00
12 mm	2.8	0.1 m	-	S-Mount	41°	A0062	€ 28.00
12 mm	2.8	0.1 m	yes*	S-Mount	41°	A0062-C	€ 28.00
Suitable for sensors up to 1/2.3" and up to 10 Mpix					at 1/2.5"		
5.4 mm	2.5	0.2 m	-	S-Mount	66°	A0076	€ 98.00
5.4 mm	2.5	0.2 m	yes*	S-Mount	66°	A0076-C	€ 98.00

PRACTICAL TIP

Lens Calculation

For a simple determination of the required focal length, you can use this approximate formula:

$$f = \frac{s}{O} \cdot D$$

- f = Lens focal length
- s = Sensor width
- O = Object width
- D = Distance camera to object

Sensor-Format	s
1/2.5" (VM-x17)	5.7 mm
1/2.6" (VM-x20)	5.73 mm
1/4" (VM-x16)	3.84 mm

* IR filter is recommended when using color cameras
 ** for VM-016 special lens holder necessary
 *** at 1/2.5 and 1/2.6 sensors, without dewarping vignetting visible

C/CS-MOUNT FIXED FOCAL LENGTH 1/2", 1.3 MPiX

Focal length	Iris range	MOD	Lens mount	Angle of view 1/3"	Locking screws	Article Number	Price in EUR (plus VAT)
4.8 mm	1.8...C	0.2 m	C-Mount	55°07'	yes	A0016	€ 183.00
6.0 mm	1.2...C	0.2 m	C-Mount	43°33'	-	A0053	€ 156.00
8.5 mm	1.5...C	0.2 m	C-Mount	31°52'	yes	A0047	€ 132.00
12 mm	1.2...22	0.2 m	C-Mount	22°04'	yes	A0035	€ 116.00
16 mm	1.4...22	0.3 m	C-Mount	16°55'	yes	A0026	€ 112.00
25 mm	1.4...22	0.3 m	C-Mount	10°58'	yes	A0007	€ 136.00
35 mm	1.6...16	0.35 m	C-Mount	7°51'	yes	A0051	€ 162.00
50 mm	2.8...22	0.9 m	C-Mount	5°30'	yes	A0052	€ 169.00
50 mm	1.4...C	1.0 m	C-Mount	5°30'	yes	A0049	€ 189.00

C/CS-MOUNT ZOOM- AND VARIO-LENSES

Focal length	Iris range	MOD	Lens mount	diameter, length	Locking screws	Article Number	Price in EUR (plus VAT)
Suitable for sensors up to 1/2" and up to 3 MPiX							
4.0..12.0 manuell	1.2...C manuell	0.3 m	C-Mount	40.0 mm 50.3 mm	yes	A0066	€ 126.00

Individual Optics for your Series Product Our Optics and Camera Assembly Service

PHYTEC onfigures the optics of your camera module individually according to the requirements of your project. Special requirements such as optical filters can also be taken into account.

Project Consulting Optics

We accompany your project holistically from planning to production. Based on your project description, we create proposals for the optical configuration and provide you with samples of suitable lenses.

Series Production and Assembly

At our dust-protected workstations, we assemble and adjust your camera modules according to your specifications. This way, you receive perfectly adjusted camera modules, while at the same time the need for corresponding workstations in your final assembly is eliminated and expenses are reduced.



We can advise you personally on the various possibilities:

contact@phytec.de

Camera Module Overview

CMOS-Camera Boards for Microprocessor-Modules



The phyCAM-System –

Perfect Integration of Cameras in Serial Products Camera boards with a phyCAM interface can be connected directly to the digital camera interface of the PHYTEC microprocessor boards. This enables the easy integration of camera technology into compact, customized products.

High Flexibility – Easy Adaption

Controller modules and camera boards together form a modular system from which the product developer can select the optimum combination. The cameras can be easily exchanged on the hardware side – even during the design phase. All camera boards have standardized dimensions. Each camera is optionally available as either a plain board version or with lens holders for C/CS-Mount or M12 lenses.

Software Driver Included

The Board-Support-Packages (BSPs) of compatible PHYTEC controller modules contain the appropriate software drivers for the cameras. This allows cameras to be directly integrated into applications under Embedded Linux. Under Linux, the cameras can be accessed via the V4L2 interface.

The camera properties are supported as V4L2 Controls. The Linux drivers are integrated into the BSPs, are ready for use and do not need to be adapted separately.

RTG
Linux drivers
"ready-to-go"
are included in
the phyCORE-
BSPs!

LENS HOLDER

Each phyCAM module is optionally available with a completely mounted M12 or C/CS mount lens holder.



Order code suffix	-M12	-H
Lens Holder	M12 (0.5), S-mount	C/CS-mount

→ Matching Lenses see page 30

SUITABLE CAMERA CABLE

The phyCAM interfaces allow our camera modules to be connected to development and application boards without any adapters. Our delivery program includes various standard lengths. For series projects, the cables can be individually customized.

→ To product page



		NEW 				
Image Resolution	1920 x 1200 (2.3 MPix)	1920 x 1200 (2.3 MPix) Mini	2592 x 1944 (5 MPix)	2592 x 1944 (5 MPix) Mini	1280 x 800 (1 MPix)	1280 x 800 (1 MPix) Mini
Camera Series	VM-020	VM-120	VM-017	VM-117	VM-016	VM-116
Color / Monochrome	-COL / -BW	-COL / -BW	-COL / -BW	-COL / -BW	-COL / -BW	-COL / -BW
Image Sensor (-COL/-BW)	AR0234	AR0234	AR0521	AR0521	AR0144	AR0144
Color Format (-COL/-BW)	Bayer Pattern / Y	Bayer Pattern / Y	Bayer Pattern / Y	Bayer Pattern / Y	Bayer Pattern / Y	Bayer Pattern / Y
Optical Format	1/2.6" 5.761 mm x 3.6 mm	1/2.6" 5.761 mm x 3.6 mm	1/2.5" 5.7 mm x 4.3 mm	1/2.5" 5.7 mm x 4.3 mm	1/4" 3.84 mm x 2.4 mm	1/4" 3.84 mm x 2.4 mm
Pixel Size	3 µm x 3 µm	3 µm x 3 µm	2.2 µm x 2.2 µm	2.2 µm x 2.2 µm	3 µm x 3 µm	3 µm x 3 µm
Dynamic Range	71.4 dB	71.4 dB	40 dB	40 dB	71.4 dB	71.4 dB
High Dynamic Range	-	-	-	-	-	-
Shutter Type	Global	Global	Rolling	Rolling	Global	Global
Features (optional)	Strobe / Trigger / EEPROM	Strobe/Trigger/EEPROM	Strobe / Trigger / EEPROM	Strobe / Trigger	Strobe / Trigger / EEPROM	Strobe / Trigger
Operating Temperature	-25°C...+85°C	-25°C...+85°C	-25°C...+85°C (Junction)	-25°C...+85°C (Junction)	-25°C...+85°C	-25°C...+85°C
PCB Dimensions	34 mm x 34 mm	18 mm x 26 mm	34 mm x 34 mm	18 mm x 26 mm	34 mm x 34 mm	18 mm x 26 mm
Interface	phyCAM-M MIPI CSI-2	phyCAM-L FPD Link III	phyCAM-M MIPI CSI-2	phyCAM-M MIPI CSI-2	phyCAM-M MIPI CSI-2	phyCAM-M MIPI CSI-2
Frame Rate (full-size image)	120 fps (max.)	120 fps (max.)	to 60 fps	to 60 fps	to 60 fps	to 60 fps
Frame Rate (Standard Video)	134 fps (Full HD)	134 fps	134 fps (Full HD)	120 fps (Full HD)	66 fps (HD)	66 fps (HD)
Video Interface	8/10 Bit	8/10 Bit	8/10/12 Bit	8/10/12 Bit	8/10/12 Bit	8/10/12 Bit
Supply Voltage	3.3 V DC	4.5 -13.2 V DC	3.3 V DC	3.3 V DC	3.3 V DC	3.3 V DC
Article Number	VM-020-C-M VM-020-M-M	VM-020-C-L VM-020-M-L	VM-120-C-M VM-120-M-M	VM-017-COL-M VM-017-BW-M	VM-017-COL-L VM-017-BW-L	VM-117-COL-M VM-117-BW-M
					VM-016-COL-M VM-016-BW-M	VM-016-COL-L VM-016-BW-L
						VM-016-COL-P VM-016-BW-P
						VM-016-COL-S VM-016-BW-S
						VM-116-COL-M VM-116-BW-M



Processor Platforms for Embedded Vision Development Kits for Systems with Digital Cameras

Get started with an Embedded Imaging Kit

In our kits, we have put together all the necessary components of an embedded system with integrated image processing. This means you can quickly and effectively create your individual image processing solution. Due to the flexibility of the standardized camera interfaces, the camera characteristics can be adapted to your requirements even during the design phase.

Software driver included

Our development kits contain the appropriate software drivers to address the camera boards from your own applications. Access to the camera driver under Linux is via V4L2. This allows a variety of middleware such as GStreamer, OpenCV and HALCON or the application to access the phyCAM cameras directly via a widely used standard interface. The cameras are matched to the boards and do not require an adapter. Camera functions are adjustable via V4L2 controls. PHYTEC provides demo applications to test camera functions and to display a camera image.



The development kits can also be combined with other phyCAM cameras.

We are happy to advise you and put together your kit individually:

contact@phytec.de

NEW

ARM	Cortex®-A72	Cortex®-A53	Cortex®-A53	Cortex®-A53	Cortex®-A7	Cortex®-A7		
Kit Modul Board	Embedded Imaging Kit phyCORE-AM68x	Embedded Imaging Kit phyCORE-i.MX 8M Plus phyBOARD-Pollux	Embedded Imaging Kit phyCORE-i.MX 8M Mini phyBOARD-Polis	Embedded Imaging Kit phyCORE-i.MX 8M Nano	Embedded Imaging Kit phyCORE-STM32MP157	Embedded Imaging Kit phyCORE-i.MX 6UUL phyBOARD-Segin		
Camera Interface	2x phyCAM-M	2x phyCAM-M	1x phyCAM-M	1x phyCAM-M	2x phyCAM-S+ 2x phyCAM-P	phyCAM-P		
Software	Operating System	Linux	Linux 5.x	Linux 5.x	Linux 5.x LTS	Linux 5.x		
	BSP / Image	yes / yes	yes / yes	yes / yes	yes / yes	yes / yes		
	Bootloader	-	Barebox (Uboot)	Barebox (Uboot)	Barebox (Uboot)	-	Barebox	
	Toolchain	Yocto	Yocto	Yocto	Yocto	Yocto	Yocto	
	Compiler	GNU	GNU	GNU	GNU	GNU	GNU	
	Imaging Middleware	OpenCV, ...	OpenCV	OpenCV	OpenCV	OpenCV	OpenCV	
CPU	Processor	2x Arm® Cortex®-A72	NXP i.MX 8M Plus	NXP i.MX 8M Mini	NXP i.MX 8M Nano	STM32MP151A/C, STM32MP153A/C, STM32MP157A/C	NXP i.MX 6UL	
	Clock Frequency	1x 2 GHz (Cortex-A72), 1x 1 GHz (Cortex-R5F)	4x 1.6 GHz (A53), 2x 800 MHz (M7)	4x 1.6 GHz (A53), 2x 400 MHz (M4)	4x 1.5 GHz (A53), 2x 600 MHz (M7)	2x 650 MHz + 209 MHz	1x 792 MHz	
	MMU	yes	yes	yes	yes	yes	yes	
	Video Accelerator	2x IMG BXS-64-4	GPU GC7000UltraLite	GPU GCNanoUltra	GC7000UltraLite	3D GPU Vivante - OpenGL ES 2.0 (only STM32MP157x)	-	
	Image Processor	ISP + CSI	2x ISP + ISI	CSI	ISI	tpd	PXP	
	max. Camera Resolution	2x 4k	12 MPixel / 2 x Full HD	5 MPixel	Full HD	2 MPixel	-	
	Video Compressor	H.264 D/E 4kp30 H.265 D/E 4kp30	H.265 D/E 1080p60 H.264 D/E 1080p60	H.265 -E 1080p60 H.264 D/E 1080p60	-	-	-	
	AI Acceleration	NPU (8 TOPS)	NPU (2.3 TOPS)	-	-	-	-	
	Memory	RAM	4 MB SRAM with ECC (intern)	2 GB DDR4	2 GB DDR4	1 GB DDR4	256 MB - 1 GB (DDR3LP)	512 MB DDR3
		NOR Flash	64 MB (Octal SPI/Quad SPI Flash)	-	-	-	4 MB - 16 MB QSPI (SPI)	-
NAND Flash		-	8 GB (eMMC)	8 GB (eMMC)	4 GB (eMMC)	to 1 GB SLC / eMMC	512 MB	
EEPROM		32 kB	4 kB	4 kB	4 kB	4 kB - 32 kB	4 kB	
Interfaces		Ethernet	2x GbE (1x on-board PHY/1x RGMII)	2x 10/100/1000 Mbit/s	10/100/1000 Mbit/s	10/100/1000 Mbit/s	10/100/1000 Mbit/s / RGMII	2x 10/100 Mbit/s
CAN	up to 11x CAN FD	2x	-	-	to 2x CAN FD (incl. 1x TTCAN)	1x		
USB	1x USB2.0, 1 x USB3.1 (DRD)	2x USB3.0 Host	USB2.0 Host, USB2.0 OTG	USB2.0 OTG	1x Host, 1x OTG 2.0	OTG HS, 2 x Host		
RS232	-	1x	1x	1x	-	1x		
Sound	up to 2x McASP (Audio)	yes	yes	yes	yes	yes		
SPI / I²C	up to 9, 1x QSPI / up to 9	yes / yes	yes / yes	yes / yes	yes / yes	yes / yes		
RTC	on-board	yes	yes	yes	STM32MP15x intern and extern RTC device	yes		
CF / SD / MMC	- / - / yes	- / yes / yes	- / yes / yes	- / yes / yes	3x (1x for eMMC)	- / yes / yes		
Extension Bus	-	yes	yes	yes	yes	yes		
Camera Interface	2x MIPI CSI-2 v1.3 (partly v2.0)	2x phyCAM-M (30pol)	phyCAM-M (30pol)	phyCAM-M (30pol)	1x parallel 8-bit - 14-bit	phyCAM-P (33pol)		
Kit Contents	Module	phyCORE-AM68x / TDA4x	phyCORE-i.MX 8M Plus	phyCORE-i.MX 8M Mini	phyCORE-i.MX 8M Nano	phyCORE-stm32MP15x	phyCORE-i.MX 6ULL	
	Camera	tbd	1 Mpix color camera VM-016-COL-M-M12	1 Mpix color camera VM-016-COL-M-M12	1 Mpix color camera VM-016-COL-M-M12	1 Mpix color camera VM-016-COL-P-M12	1 Mpix color camera VM-016-COL-P-M12	
	Lens	tbd	12 mm, M12 with IR cut	12 mm, M12 with IR cut	12 mm, M12 with IR cut	12 mm, M12	12 mm, M12	
	Carrier Board	yes	yes	yes	yes	yes	yes	
	Display	tbd	HDMI connector	10" Display inkl.	HDMI connector	MIPI DSI-2 or parallel 18-bit or HDMI	WVGA 7" Display incl.	
	Touch	tbd	opt.	opt.	opt.	opt.	opt.	
	BSP / Toolchain	USB-Stick	USB-Stick	USB-Stick	USB-Stick	USB-Stick	USB-Stick	
	QuickStart Instructions	yes	yes	yes	yes	yes	yes	
	Schematics	yes	yes	yes	yes	yes	yes	
	Start-up Support	yes	yes	yes	yes	yes	yes	
Order	Article Number	tbd	KPB-03123-Video-L01	KPB-02820-Video-L01	KPCM-068-Video-L01	KPB-02013-Video-L01		
	Price in EUR (plus VAT)	tbd	€ 295.00	€ 480.00 incl. 10"-Display	€ 432.00	€ 320.00		

Headquarters | Subsidiaries

Germany

PHYTEC Messtechnik GmbH
D-55129 Mainz
t +49 6131 9221-32
f +49 6131 9221-33
www.phytec.de
www.phytec.eu

France

PHYTEC France SARL
F-72140 Sillé le Guillaume
t +33 2 43 29 22 33
f +33 2 43 29 22 34
www.phytec.fr

North America

PHYTEC America LLC
Bainbridge Island, WA 98110
t +1 206 780-9047
f +1 206 780-9135
www.phytec.com

