

miniMODUL-535

QuickStart Instructions

**Using PHYTEC FlashTools98 for Windows and the Keil μ Vision2
Software Evaluation Development Tool Chain**

Note: The PHYTEC Spectrum CD includes the electronic version of
the English miniMODUL-535 Hardware Manual

Edition: December 2002

A product of a PHYTEC Technology Holding company

In this manual are descriptions for copyrighted products that are not explicitly indicated as such. The absence of the trademark (™) and copyright (©) symbols does not imply that a product is not protected. Additionally, registered patents and trademarks are similarly not expressly indicated in this manual.

The information in this document has been carefully checked and is believed to be entirely reliable. However, PHYTEC Meßtechnik GmbH assumes no responsibility for any inaccuracies. PHYTEC Meßtechnik GmbH neither gives any guarantee nor accepts any liability whatsoever for consequential damages resulting from the use of this manual or its associated product. PHYTEC Meßtechnik GmbH reserves the right to alter the information contained herein without prior notification and accepts no responsibility for any damages which might result.

Additionally, PHYTEC Meßtechnik GmbH offers no guarantee nor accepts any liability for damages arising from the improper usage or improper installation of the hardware or software. PHYTEC Meßtechnik GmbH further reserves the right to alter the layout and/or design of the hardware without prior notification and accepts no liability for doing so.

© Copyright 2002 PHYTEC Meßtechnik GmbH, D-55129 Mainz.

Rights - including those of translation, reprint, broadcast, photomechanical or similar reproduction and storage or processing in computer systems, in whole or in part - are reserved. No reproduction may occur without the express written consent from PHYTEC Meßtechnik GmbH.

	EUROPE	NORTH AMERICA
Address:	PHYTEC Technologie Holding AG Robert-Koch-Str. 39 D-55129 Mainz GERMANY	PHYTEC America LLC 203 Parfitt Way SW, Suite G100 Bainbridge Island, WA 98110 USA
Ordering Information:	+49 (6131) 9221-30 order@phytec.de	1 (800) 278-9913 info@phytec.com
Technical Support:	+49 (6131) 9221-31 support@phytec.de	1 (800) 278-9913 support@phytec.com
Fax:	+(49) 6131-9221-33	1 (206) 780-9135
Web Site:	http://www.phytec.de	http://www.phytec.com

3rd Edition: December 2002

1	Introduction to the Rapid Development Kit	1
1.1	Rapid Development Kit Documentation	1
1.2	Overview of this QuickStart Instruction.....	2
1.3	System Requirements	3
1.4	The PHYTEC miniMODUL-535	4
1.5	The Keil Software Evaluation Development Tool Chain.....	7
2	Getting Started.....	11
2.1	Installing Rapid Development Kit Software.....	11
2.2	Interfacing the miniMODUL-535 to a Host-PC.....	18
2.3	Starting PHYTEC FlashTools98	20
2.4	Downloading Example Code with FlashTools98.....	21
2.4.1	"Blinky"	26
2.4.2	"Hello"	28
3	Getting More Involved	33
3.1	Starting the Keil μ Vision2 Tool Chain.....	33
3.2	Creating a New Project and Adding an Existing Source File.....	34
3.3	Modifying the Source Code.....	40
3.4	Saving the Modifications.....	41
3.5	Setting Tool Chain Options	41
3.6	Building the Project	44
3.7	Downloading the Output File	45
3.8	"Hello2"	46
3.8.1	Creating a New Project.....	46
3.8.2	Modifying the Example Source	47
3.8.3	Setting Tool Chain Options	47
3.8.4	Building the New Project	47
3.8.5	Downloading the Output File	48
3.8.6	Starting the Terminal Emulation Program.....	49

4	Debugging	51
4.1	Preparing the Target Hardware to Communicate with μ Vision2 Target Monitor.....	52
4.2	Creating a Debug Project and Preparing the Debugger	53
4.2.1	Creating a New Project	53
4.2.2	Setting Options for Target.....	54
4.3	Preparing the Debugger.....	59
4.4	Starting the Debugger.....	61
4.5	Keil μ Vision2 Debug Features	64
4.6	Using the Keil μ Vision2 Debug Features.....	66
4.6.1	Serial Window	66
4.6.2	Breakpoints.....	67
4.6.3	Single Stepping and Watch Window.....	68
4.7	Running, Stopping and Resetting	70
4.8	Changing Target Settings for the "Final Version"	71
5	Advanced User Information.....	75
5.1	FlashTools98	75
5.2	STARTUP.A51	77
5.3	Linking and Locating	78

Figures

Figure 1:	Keil Tool Chain Overview	8
Figure 2:	Development Board Overview	18
Figure 3:	Suitable Development Board Jumper Settings	19
Figure 4:	Power Connector	19
Figure 5:	Memory Model for Use with the Keil Monitor (32 kByte RAM).....	55

1 Introduction to the Rapid Development Kit

This QuickStart provides:

- general information on the PHYTEC miniMODUL-535 Single Board Computer (SBC)
- an overview of Keil's μ Vision2 software evaluation development tool chain, and
- instructions on how to run example programs on the miniMODUL-535, mounted on the PHYTEC Development Board 5V, in conjunction with μ Vision2 IDE

Please refer to the [miniMODUL-535 Hardware Manual](#) for specific information on such board-level features as [jumper configuration](#), [memory mapping](#) and [pin layout](#). Selecting the links on the electronic version of this document links to the applicable section of the miniMODUL-535 Hardware Manual.

1.1 Rapid Development Kit Documentation

This "Rapid Development Kit" (RDK) includes the following electronic documentation on the enclosed "PHYTEC Spectrum CD-ROM":

- the PHYTEC [miniMODUL-535 Hardware Manual](#) and [Development Board Hardware Manual](#)
- controller [User's Manuals and Data Sheets](#)
- this QuickStart Instructions with general "Rapid Development Kit" description, software installation hints and three example programs enabling quick out-of-the box start-up of the miniMODUL-535 in conjunction with the Keil software development tools.

1.2 Overview of this QuickStart Instruction

This QuickStart Instruction gives a general "Rapid Development Kit" description, as well as software installation hints and four example programs enabling quick out-of-the box start-up of the miniMODUL-535 in conjunction with the Keil software development tools. It is structured as follows:

- 1) The "*Getting Started*" section uses two example programs: "*Blinky*" and "*Hello*" to demonstrate the download of user code to the Flash device using PHYTEC FlashTools.
- 2) The "*Getting More Involved*" section provides step-by-step instructions on how to modify both examples, create and build new projects and generate and download output files to the miniMODUL-535 using the Keil tool chain and FlashTools98.
- 3) The "*Debugging*" section provides a third example program - "Debug" - to demonstrate monitoring of the board and simple debug functions using the μ Vision2 debug environment.

In addition to dedicated data for this Rapid Development Kit, this CD-ROM contains supplemental information on embedded micro-controller design and development.

1.3 System Requirements

Use of this "Rapid Development Kit" requires:

- the miniMODUL-535 SBC module
- the PHYTEC Development Board with the included DB-9 serial cable and AC adapter supplying 8-13 V / min. 250 mA
- the PHYTEC Spectrum CD
- an IBM-compatible host-PC (486 or higher running at least Windows95/98)

For more information and example updates, please refer to the following sources:

PHYTEC

<http://www.phytec.com> - or - <http://www.phytec.de>
support@phytec.com - or - support@phytec.de

The logo for Keil Software, featuring a stylized blue square icon with a white arrow pointing right, followed by the text "KEIL SOFTWARE" in blue.

<http://www.keil.com>
support@keil.com

1.4 The PHYTEC miniMODUL-535

The miniMODUL-535 represents an affordable, yet highly functional Single Board Computer (SBC) solution in subminiature dimensions (85 x 55 mm). Standard versions of the miniMODUL-535 feature the following 8051-compatible Infineon C500 family controllers:

- the SAB80C535, featuring an 8-channel on-chip A/D converter with 8-bit resolution;
- the SAB80C515A, featuring an 8-channel on-chip A/D converter with 10-bit resolution

All applicable data/address lines and applicable signals extend from the underlying logic devices to standard-width (2.54 mm/0.10 in.) pin headers lining the circuit board edges. This enables the miniMODUL-535 to be plugged like a "big chip" into target hardware.

The standard memory configurations of the miniMODUL-535 features 32 (to 160) kByte external SRAM and 128 (to 512) kByte external Flash for storage of user code. The Flash device allows direct on-board programming. Free Chip Select signals are available for external I/O connectivity.

The module communicates by means of an RS-232 transceiver and operates within a standard industrial range of 0 to +70 degrees C. and requires only a 250 mA. power source.

PHYTEC FlashTools98 enables easy on-board download of user programs.

miniMODUL-535 Technical Highlights

- SBC in credit card size dimensions (55 x 85 mm) achieved through advanced SMD technology
- populated with an Infineon SAB 80C535/80C515A controller in PLCC-68 package
- up to 18 MHz clock speed
- 32 (to 160) kByte external SRAM
- 128 (to 512) kByte external Flash supporting on-board download of user code from a host-PC in conjunction with PHYTEC FlashTools98 firmware
- RS-232 serial interface
- three Chip Select signals for connection to external peripherals
- 8-channel A/D converter with 8/10-bit resolution (if mounted with the 80C535 or 80C515A, respectively)
- requires only +5 V / 250 mA power source
- operates in a temperature range of 0... 70° C.
(optional -40... 85° C. temperature range available)

The PHYTEC Development Board, in EURO-card dimensions (160 x 100 mm), is fully equipped with all mechanical and electrical components necessary for the speedy and secure insertion and subsequent programming of most PHYTEC microMODUL and miniMODUL series Single Board Computers. Simple jumper configuration readies the Development Board's connectivity to any PHYTEC module, which plug pins-down into the contact strips mounted on the Development Board. One set of strips accommodates microMODULs, the other miniMODUL SBCs.

Development Board Technical Highlights

- RESET push button
- BOOT push button
- low voltage socket and voltage regulator accepting an unregulated input voltage in a range from 8 to 13 VDC
- DB-9 connector (configured as an RS-232 interface)
- second DB-9 connector configurable as an RS-485, CAN or a second RS-232 interface depending on the implemented Single Board Computer and user needs
- VG96-connector
- simple jumper configuration allowing use of the Development Board with various PHYTEC Single Board Computers
- wire wrap field (60 x 60 mm) supporting development of user-designed peripheral hardware

1.5 The Keil Software Evaluation Development Tool Chain

The Keil software evaluation development tool chain fully supports the entire C500 and 8051-derivative microcontroller family, including the Infineon SAB 80C535/80C515A controller. This includes a C compiler, macroassembler, linker/locator and the simulator and target monitor within the μ Vision2 IDE.

The Keil tool chain consists of the following executables:

- **C Compiler** cx51.exe
- **Assembler** ax51.exe
- **Linker** bl51.exe
- **Converter** oh51.exe
- **μ Vision2** uv2.exe (a Windows-based application)

Once installed, the default destination location for the DOS-based files is the *C:\Keil\C51\Bin* directory while μ Vision2 is in *C:\Keil\Uv2*. Access to these programs from Windows is accomplished within μ Vision2. The entire tool set can be run from μ Vision2 or directly from DOS with batch files. The evaluation version of the Keil tool chain is restricted to a manipulable code size of 2 kByte. In addition the code will automatically be located at 0x4000 in order to prevent unauthorized use of this version for programming of common devices with internal code memory less or equal than 2 kByte. Other than these restrictions, the evaluation tool chain functions exactly as the full version does, enabling full evaluation of the features and functionality of Keil development tools. The full version has no such restrictions, both are fully ANSI compliant.

μVision2 IDE

μVision2 is a Windows-based Graphical User Interface for the C compiler and assembler. All compiler, assembler and linker options are set with simple mouse clicks. μVision2 runs under Windows 95/98/ME/NT/2000 and XP. This Integrated Development Environment (IDE) has been expressly designed with the user in mind and includes a fully functional editor.

All IDE commands and functions are accessible via intuitive pull-down menus with prompted selections. An extensive Help utility is included. External executables can be run from within μVision2, including emulator software.

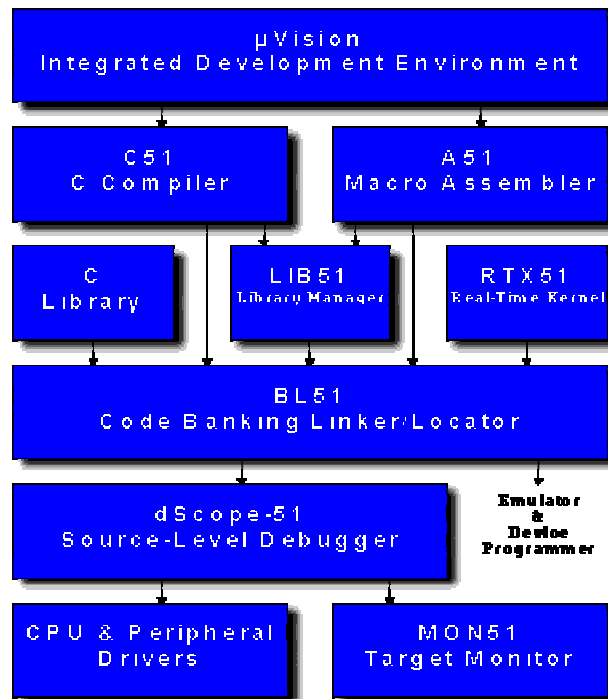

Figure 1: Keil Tool Chain Overview

Cx51 C Compiler

The Cx51 ANSI compiler is specifically designed for the 8051 microcontroller family with enhanced memory architecture. The compiler can be run either in a DOS box under Windows or directly from μ Vision2.

Ax51 Macroassembler

The assembler can be run either in a DOS box under Windows or directly from μ Vision2.

BL51 Code Banking Linker/Locator

The BL51 linker/locator is used to join re-locatable object modules and library files together and to locate them to fixed memory locations. It supports Code Banking for easy management of multiple code-banks to allow applications with more than 64 kByte of code. The library and object files created with the Cx51 compiler or the Ax51 assembler are provided by Keil. This process results in absolute object modules. The BL51 is DOS-based and can be run within a DOS box under Windows or directly from μ Vision2. A map file (**.m51*) can be produced, giving details of the memory structure. The object file may be specified to contain debugging information as required by simulators, debuggers and emulators. The BL51 also supports an overlay mechanism for variables to optimize the use of the size-restricted internal RAM.

OH51 Object-Hex Converter

The Keil OH51 object-to-hex converter transforms an absolute object file produced by the BL51 Banking Linker into a standard Intel **.hex* file. This file is suitable as an input to the PHYTEC FlashTools or for programming into an EPROM or an emulator. OH51 can be run in a DOS box under Windows or directly from μ Vision2.

Debug Environment

µVision2 contains a software simulator supporting debugging either via software on a host-PC or in target hardware. When operated in conjunction with the Keil monitor resident in target hardware µVision2 enables the following debugging functions:

- run/halt
- set breakpoints
- examine/change memory
- view the stack
- view/set peripheral information
- apply virtual external signals

µVision2 has a performance analysis feature to ensure your code runs efficiently. In addition, µVision2 has a disassembler/assembler that allows the modification of user code without recompiling.

2 Getting Started

What you will learn with this Getting Started example:

- installing Rapid Development Kit software
- starting PHYTEC FlashTools98 download utility
- interfacing the miniMODUL-535, mounted on the PHYTEC Development Board, to a host-PC
- downloading example user code in Intel hexfile format from a host-PC to the external Flash memory using FlashTools98

2.1 Installing Rapid Development Kit Software

- Insert the PHYTEC Spectrum CD into the CD-ROM drive of your host-PC.

The PHYTEC Spectrum CD should automatically launch a setup program that installs the software required for the Rapid Development Kit as specified by the user. Otherwise the setup program *start.exe* can be manually executed from the root directory of the PHYTEC Spectrum CD.

The following window appears:

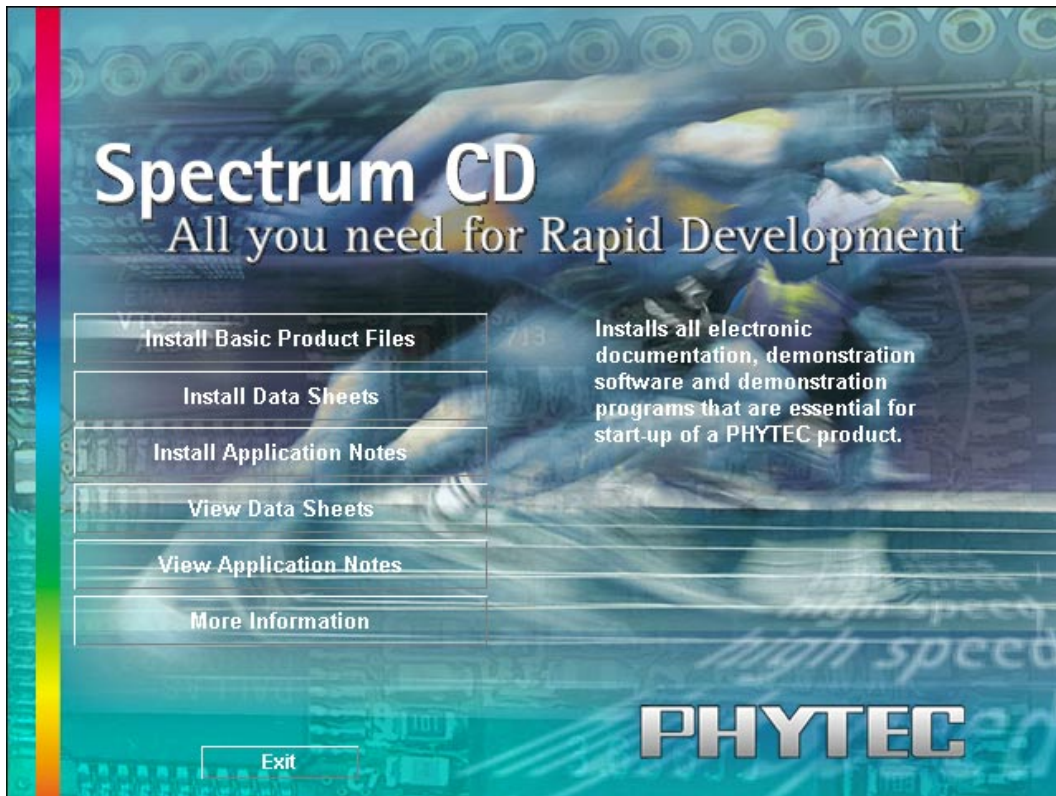

- Choose the *Install Basic Product Files* button.
- After accepting the Welcome window and license agreement, select the destination location for installation of Rapid Development Kit software and documentation.

The default destination location is **C:\PHYBasic**. All path and file statements within this QuickStart Instruction are based on the assumption that you accept the default install paths and drives. If you decide to individually choose different paths and/or drives you must consider this for all further file and path statements.

We recommend that you accept the default destination location.

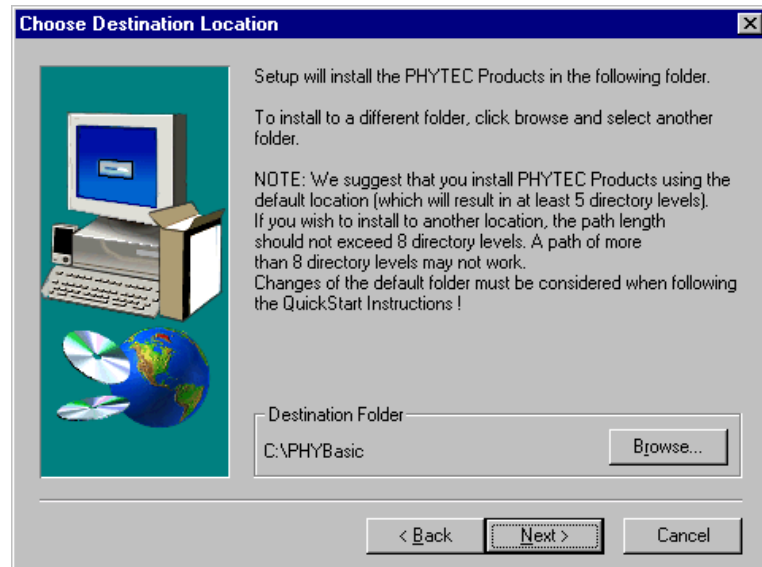

- In the next window, select your Rapid Development Kit of choice from the list of available products. By using the *Change...* button, advanced users can select in detail which options should be installed for a specific product.

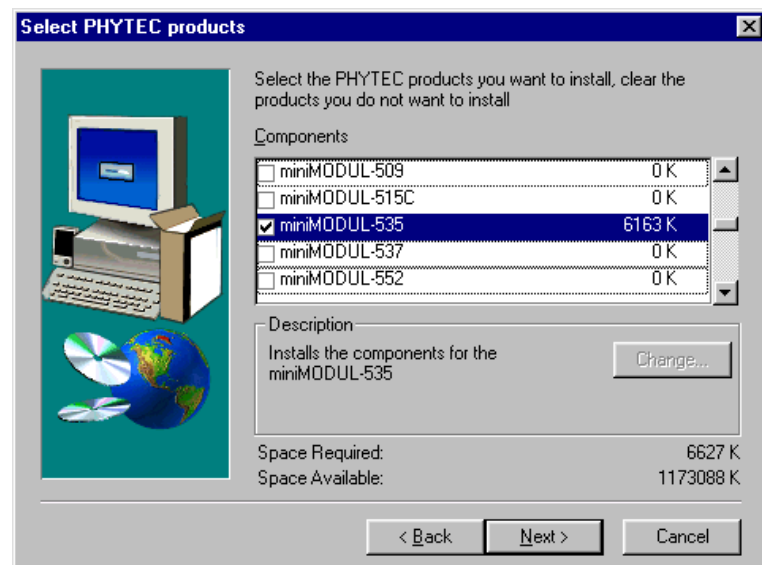

All Kit-specific content will be installed to a Kit-specific subfolder of the Rapid Development Kit root folder that you have specified at the beginning of the installation process.

All software and tools for this miniMODUL-535 RDK will be installed to the *\PHYBasic* folder on your hard drive.

- In the next dialog you must choose whether to copy the selected documentation as **.pdf* files to your hard drive or to install a link to the file on the Spectrum CD.

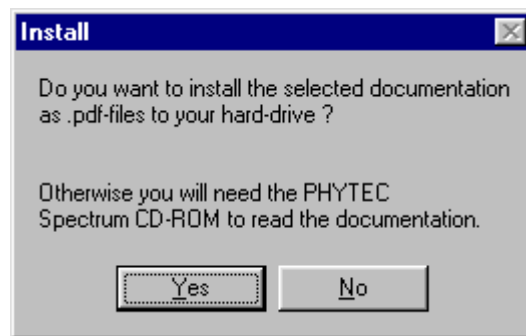

If you decide **not** to copy the documentation to your hard drive, you will need the PHYTEC Spectrum CD-ROM each time you want to access these documents. The installed links will refer to your CD-ROM drive in this case.

If you decide to copy the electronic documentation to your hard drive, the documentation for this miniMODUL-535 RDK will also be installed to the kit-specific subfolder. The manuals of the PHYTEC Development Board are copied to their own specific subfolder (e.g. *\PHYBasic\DevBmM*) because each Development Board is suitable for multiple SBC's and is not dedicated to a specific RDK.

Setup will now add program icons to the program folder, named *PHYTEC*.

- Click on *Finish* to complete the installation of PHYTEC products.

- In the next window, you choose the Keil EK51 software development tool chain¹.

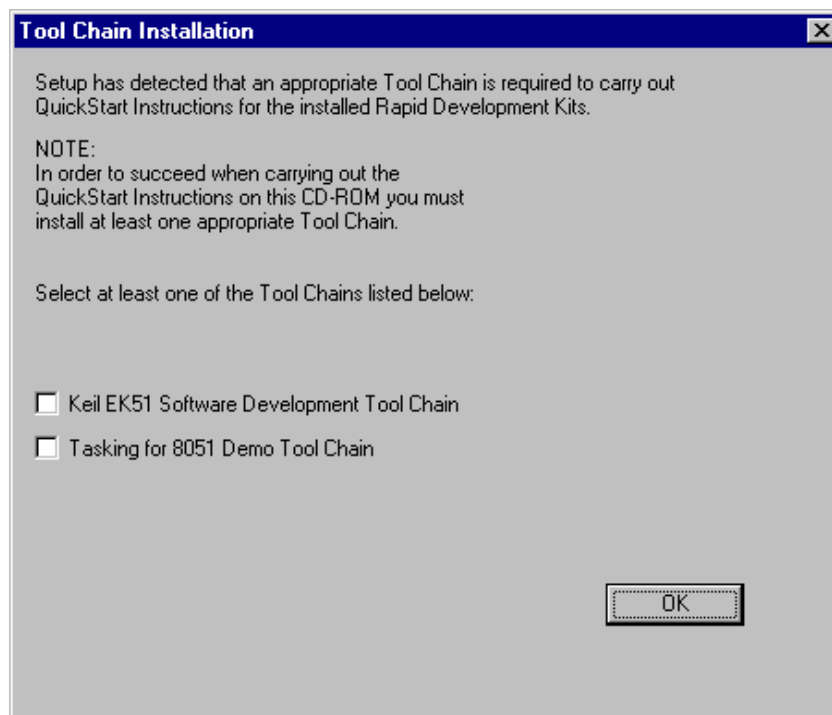

The applicable Keil tool chain must be installed to ensure successful completion of this QuickStart Instruction. Failure to install the proper software could lead to possible version conflicts, resulting in functional problems.

We recommend that you install μ Vision2 from the Spectrum CD-ROM even if other versions of μ Vision2 are already installed on your system. These QuickStart Instructions and the demo software included on the CD-ROM have been specifically tailored for use with one another.

- After accepting the Welcome window and license agreement, select the destination location for installation of the Keil evaluation development tool chain. The default location is *C:\Keil*.

¹: If installing a different tool chain, please refer to the corresponding QuickStart manual.

The Keil evaluation development tool chain will be installed to your hard drive. Additional software, such as Adobe Acrobat Reader, will also be offered for installation.

In the following windows you can decide to install FlashTools98 software and the Acrobat Reader.

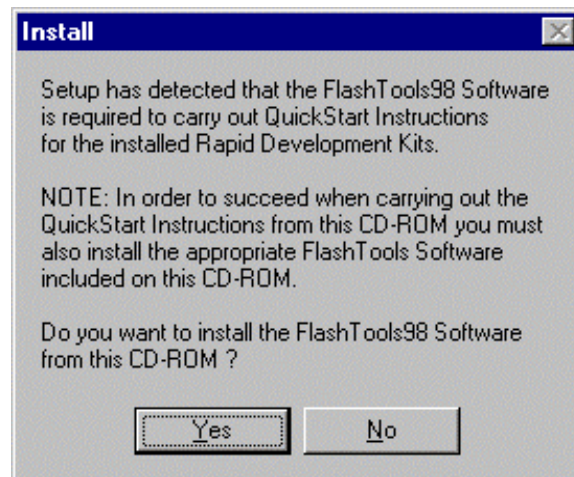

The applicable FlashTools98 software must be installed to ensure successful completion of this QuickStart Instruction. Failure to install the proper software could lead to possible version conflicts, resulting in functional problems.

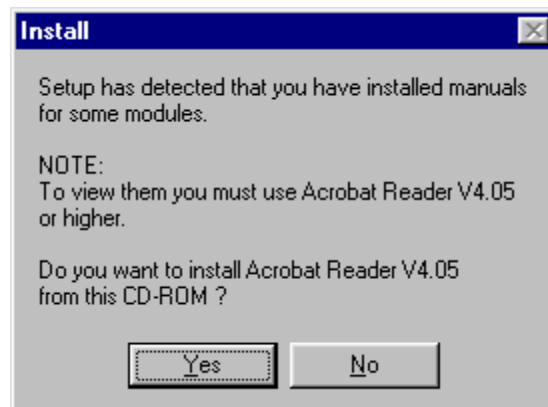

- Decide if you want to begin the QuickStart Instruction immediately by selecting the appropriate checkbox and click on *Finish* to complete the installation.

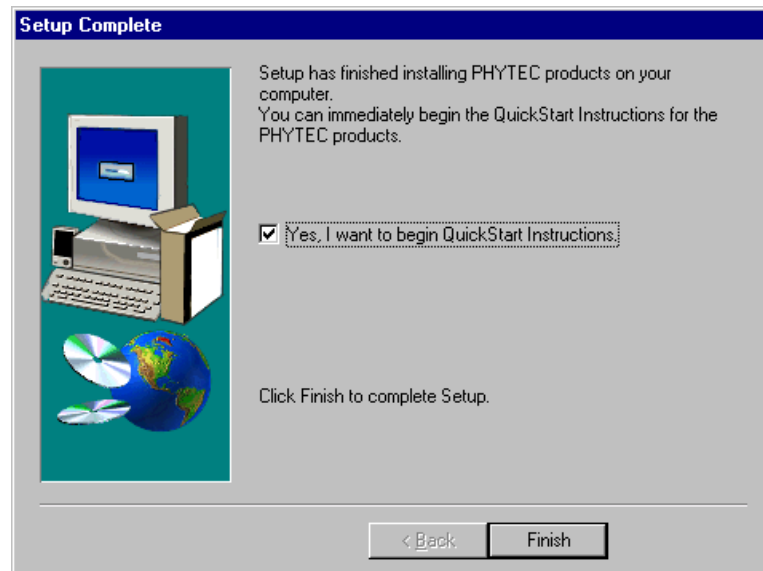

2.2 Interfacing the miniMODUL-535 to a Host-PC

Connecting the miniMODUL-535, mounted on the PHYTEC Development Board, to your computer is simple:

- As shown in the figure below, if the miniMODUL is not already pre-installed, mount it pins-down onto the Development Board's exterior receptacle footprint (X1).
- Ensure that pin 1 of module (denoted by the hash stencil mark on the PCB) matches pin 1 of the receptacle on the Development Board.
- Ensure that there is a solid connection between the module pins and the Development Board receptacle.

Caution:

Take precautions not to bend the pins when the miniMODUL is removed from and inserted onto the Development Board.

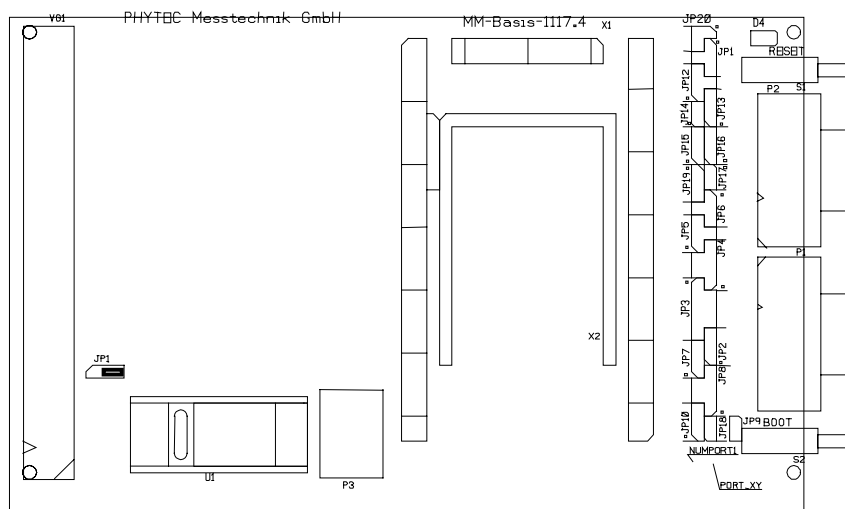

Figure 2: Development Board Overview

- Configure the Jumpers on the Development Board as indicated below. This correctly routes the RS-232 signals to the DB-9 connector (P1) on the Development Board.

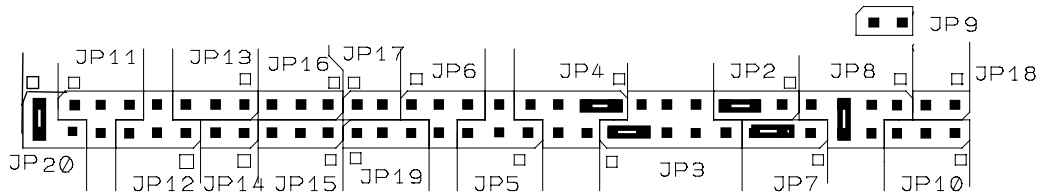

Figure 3: Suitable Development Board Jumper Settings

- Configure Jumper JP1 on the Development Board as indicated below to supply the board through the power socket (P3).



- Connect the RS-232 interface of your computer to the DB-9 RS-232 interface on the Development Board (P1) using the included serial cable.
- Using the included power adapter, connect the power socket on the board (P3) to a power supply (refer to Figure 4 for the correct polarity).

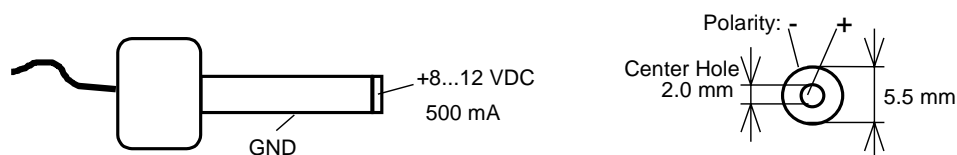

Figure 4: Power Connector

- Simultaneously press the Reset (S1) and Boot (S2) buttons on the Development Board, first releasing the Reset (S1) and then, two to three seconds later, release the Boot (S2) button.

This sequence of pressing and releasing the Reset (S1) and Boot (S2) buttons always renders the mimMODUL-535 into the Flash programming mode (FPM). Use of FlashTools98 requires that the miniMODUL-535 be in FPM. See section 2.4, "Downloading Example Code with FlashTools98" for more details.

The miniMODUL should now be properly connected via the Development Board to a host-PC and power supply. You are now ready to program the miniMODUL-535, as mounted on the Development Board. This miniMODUL/Development Board combination is also referred to as "target hardware".

2.3 Starting PHYTEC FlashTools98

FlashTools98 should have been installed during the initial setup procedure as described in section 2.1. If not, you can manually install it using the *setup.exe* file located in the folder `\Software\Flasht98\`.

FlashTools98 for Windows is a utility program that allows download of user code in Intel **.hex* file format from a host-PC to a PHYTEC SBC via an RS-232 connection.

FlashTools98 consists of firmware resident in the external Flash and corresponding software installed on the host-PC. Proper connection of a PHYTEC SBC to a host-PC enables the software portion of FlashTools98 to recognize and communicate to the firmware portion.

- You can start FlashTools98 by selecting it from the *Programs* menu using the Windows *Start* button.

It is recommended that you drag the FlashTools98 icon onto the desktop of your PC. This enables easy start of FlashTools98 by double-clicking on the icon.

2.4 Downloading Example Code with FlashTools98

- Start FlashTools98 for Windows by double-clicking on the FlashTools98 icon or by selecting *FlashTools98* from within the *Programs/Phytec* program group.
- The Communication Setup tab of the FlashTools98 tabsheet window will now appear. Here you can specify connection properties to the miniMODUL-535.

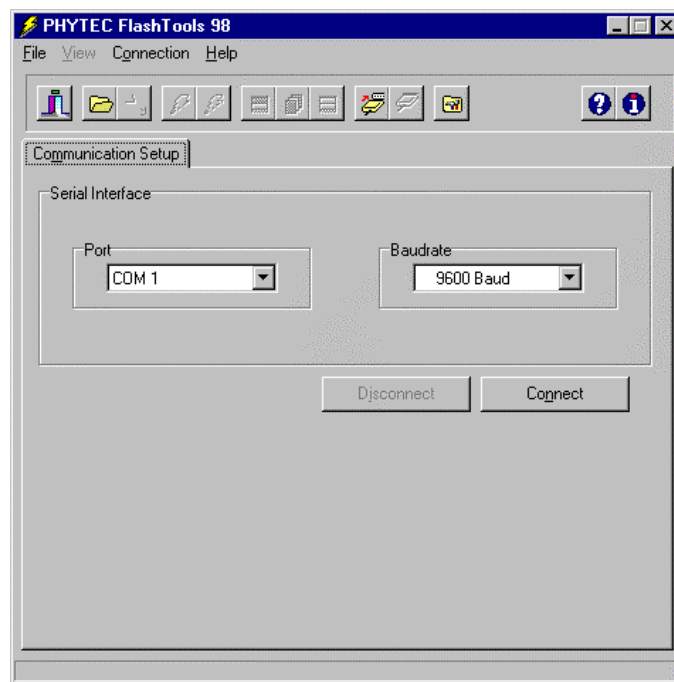

- Choose the correct serial port for your host-PC and a 9,600 baud rate.

Note:

Always ensure that the miniMODUL-535 is in Flash programming mode before clicking on the *Connect* button.

- Click the *Connect* button to establish connection to the target hardware.

The microcontroller firmware tries to automatically adjust to the baud rate selected within the baud rate tab. However, it may occur that the selected baud rate can not be attained. This results in a connection error. In this case, try other baud rates to establish a connection. Before attempting each connection, be sure to reset the target hardware and render it into Flash programming mode (FPM) as described in *section 2.2*.

Returning to the FlashTool98 window, you will see tabs for the following:

*Bank Utilities*¹ enable erasure and status check of whole banks of memory specified by the user:

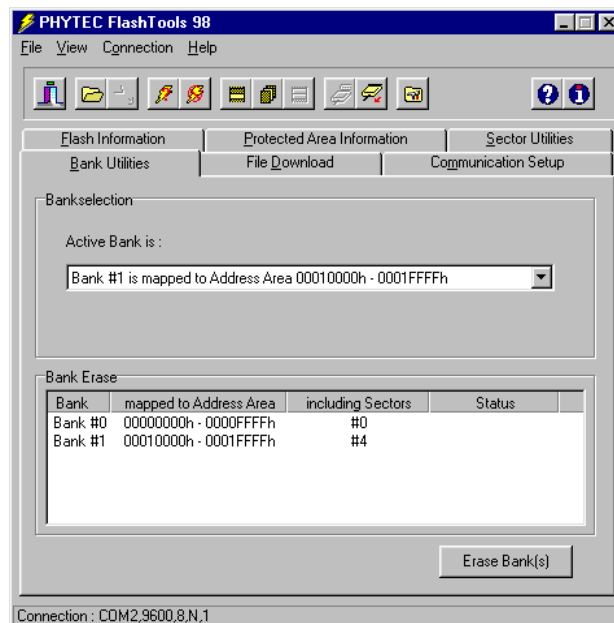

¹: The number of banks shown on the *Bank Utilities* tabsheet varies depending on the size and type of the Flash mounted on the miniMODUL-535.

*Flash Information*¹ shows Flash type, sector and address ranges in Flash memory:

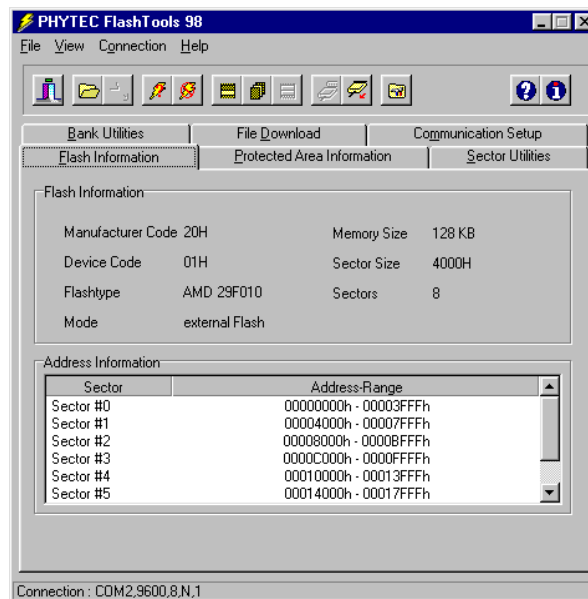

Communication Setup allows selection of the serial port and speed before the communication is initialized, or to disconnect the ongoing communication:

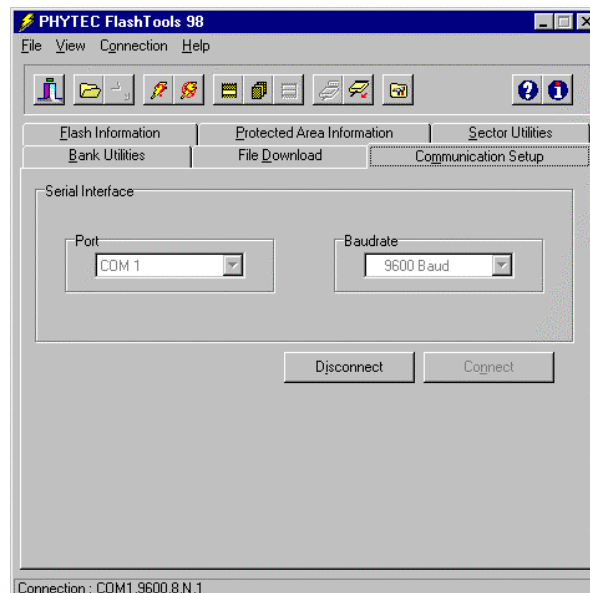

¹: The appearance of the *Flash Information* tabsheet varies depending on the size and type of the Flash mounted on the miniMODUL-535.

File Download downloads specified hexfiles to the target hardware:

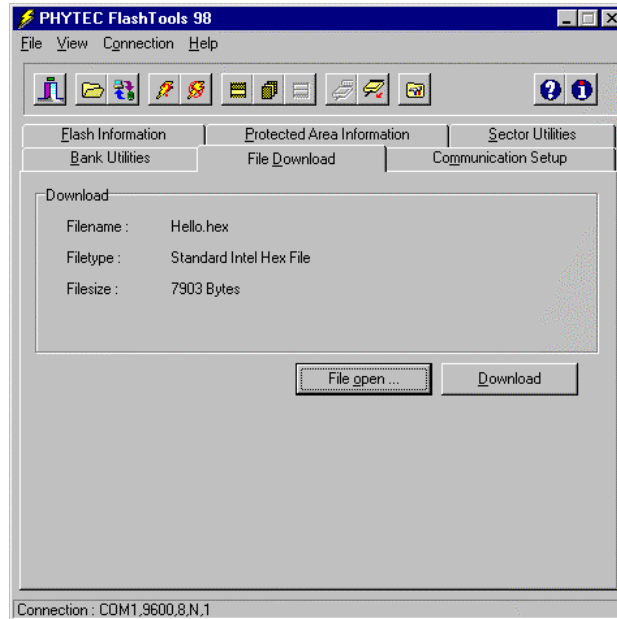

Protected Areas Information shows protected areas of Flash memory:

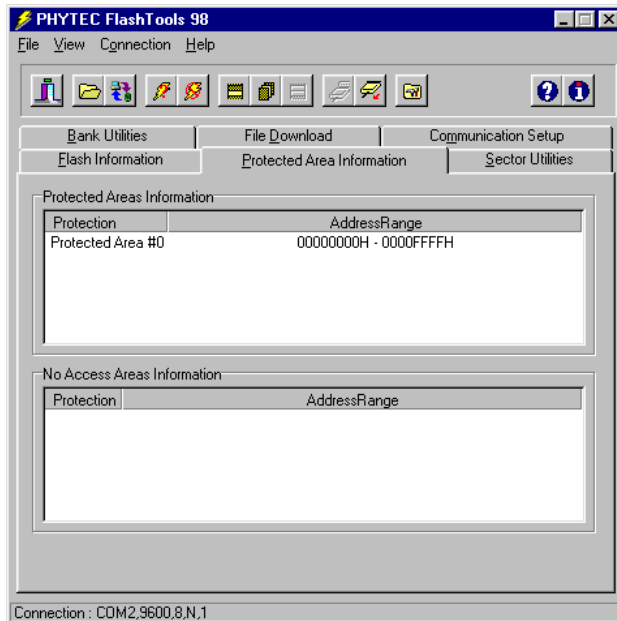

*Sector Utilities*¹ enable erasure and status check of individual sectors of Flash memory specified by the user:

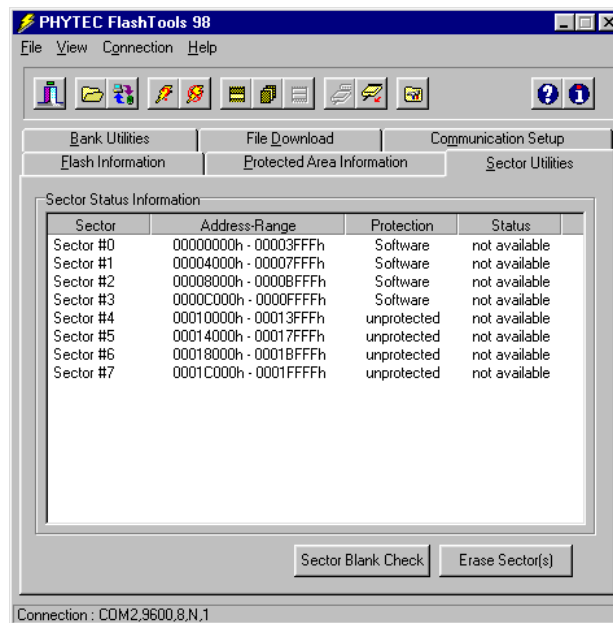

¹: The appearance of the *Sector Utilities* tabsheet varies depending on the size and type of the Flash mounted on the miniMODUL-535.

2.4.1 "Blinky"

The "Blinky" example downloads a program to the Flash that, when executed, manipulates the LED D3 on the Development Board that is located next to the Boot button S2.

- Returning to the FlashTools98 tabsheet, choose the *Bank Utilities* tab, highlight *Bank #1* within the *Bank Erase* section, and click on the *Erase Bank(s)* button to erase this memory bank.
- Wait until the status check in the lower left corner of the FlashTools98 tabsheet finishes, returning the connection properties description to the lower left corner of the window.
- Next choose the *File Download* tab and click on the *File Open* button.

The hexfile has already been installed to your hard drive during the installation procedure.

- Browse to the correct drive and path for the miniMODUL-535 Demo folder (default location **C:\PHYBasic\mM-535\Demos\Keil\Blinky\Blinky.hex**) and click *Open*.
- Click on the *Download* button. You can watch the status of the download of the **Blinky.hex** into the external Flash memory in the Download window.

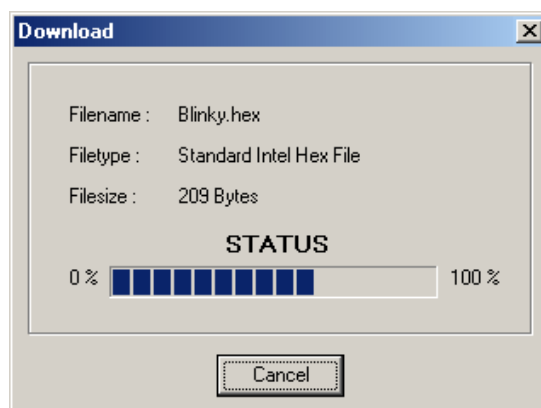

If the selected Flash bank into which you wish to download code is not empty (i.e. erased), a warning dialog box will appear, indicating "Location not empty! Please erase location and try again". In this event, select the *Bank Utilities* tab from the FlashTools98 tabsheet, highlight *Bank #1* and erase the bank. Then repeat the download procedure.

- At the end of the download, a sector-by-sector status check of the Flash memory can be viewed in the lower left corner of the FlashTools98 tabsheet window. Wait until the status check finishes before returning to work with the board. Once the status check is complete, the downloaded code can be executed.
- Returning to the *Communication* tab, click on the *Disconnect* button and exit FlashTools98.
- Press the Reset button (S1) on the Development Board to reset the target hardware and to start execution of the downloaded software.
- Successful execution of the program will flash the LED D3 with equal on and off ratio.

2.4.2 "Hello"

The "Hello" example downloads a program to the Flash that, when executed, performs an automatic baud rate detection and sends a character string from the target hardware back to the host-PC. The character string can be viewed with a terminal emulation program. This example program provides a review of the FlashTools98 download procedure. For detailed commentary on each step, described below in concise form, *refer back to sections 2.2 through 2.4.1.*

- Ensure that the target hardware is properly connected to the host-PC and a power supply.
- Reset the target hardware and force it into Flash programming mode by simultaneously pressing the Reset (S1) and Boot (S2) buttons on the Development Board and then releasing first the Reset and, two or three seconds later, the Boot button.
- Start FlashTools98.
- At the *Communication Setup* tab of the FlashTools98 tabsheet, specify the proper serial port and transmission speed (9,600 baud) for communication between host-PC and target hardware and click the *Connect* button to establish connection to the target hardware.
- Returning to the FlashTools98 tabsheet, choose the *Bank Utilities* tab, highlight *Bank #1* within the *Bank Erase* section, and click on the *Erase Bank(s)* button to erase this memory bank.
- Wait until the status check in the lower left corner of the FlashTools98 tabsheet finishes, returning the connection properties description to the lower left corner of the window.
- Next choose the *File Download* tab and click on the *File Open* button.

The demo hexfile has already been installed to your hard drive during the installation procedure.

- Browse to the correct drive and path for the miniMODUL-535 Demo folder (default location **C:\PHYBasic\mM-535\Demos\Keil\Hello\Hello.hex**) and click *Open*.
- Click on the *Download* button. You can watch the status of the download of the **Hello.hex** into the external Flash memory in the Download window.

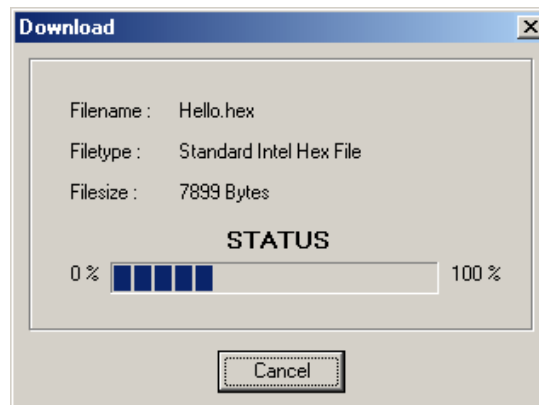

If the selected Flash bank into which you wish to download code is not empty (i.e. erased), a warning dialog box will appear, indicating "Location not empty! Please erase location and try again". In this event, select the *Bank Utilities* tab from the FlashTools98 tabsheet, highlight *Bank #1* and erase the bank. Then repeat the download procedure.

- At the end of the download, a sector-by-sector status check of the Flash memory can be viewed in the lower left corner of the FlashTools98 tabsheet window. Wait until the status check finishes before returning to work with the board. Once the status check is complete, the downloaded code can be executed.
- Returning to the *Communication* tab, click on the *Disconnect* button and exit FlashTools98.

Monitoring the execution of the Hello demo requires use of a terminal program, such as the HyperTerminal program included within Windows.

- Start the HyperTerminal program within the *Programs/Accessories* bar.
- The HyperTerminal main window will now appear¹:
- Double-click on the HyperTerminal icon "*Hypertrm*" to create a new HyperTerminal session.



- The Connection Description window will now appear. Enter "COM Direct" in the *Name* text field.
- Next click on *OK*. This creates a new HyperTerminal session named "COM Direct" and advances you to the next HyperTerminal window.

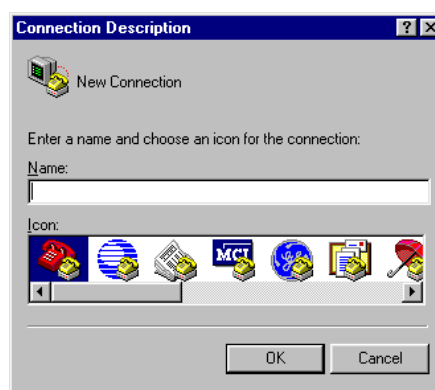

¹: The HyperTerminal window has a different appearance for different versions of Windows.

- The *COM Direct Properties* window will now appear. Specify *Direct to COM1/COM2* under the *Connect Using* pull-down menu (be sure to indicate the correct COM setting for your system).

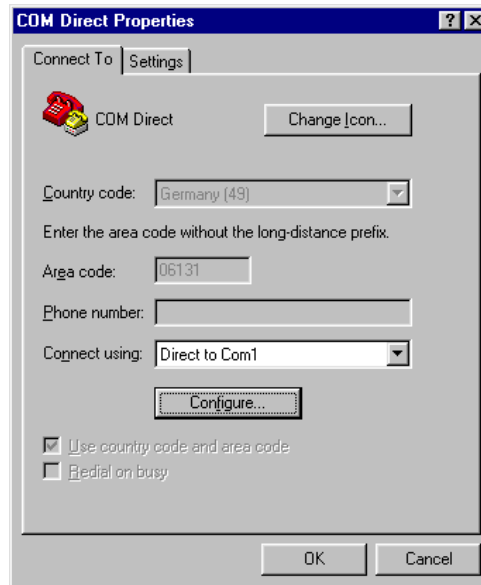

- Click the *Configure* button in the *COM Direct Properties* window to advance to the next window (*COM1/COM2 Properties*).

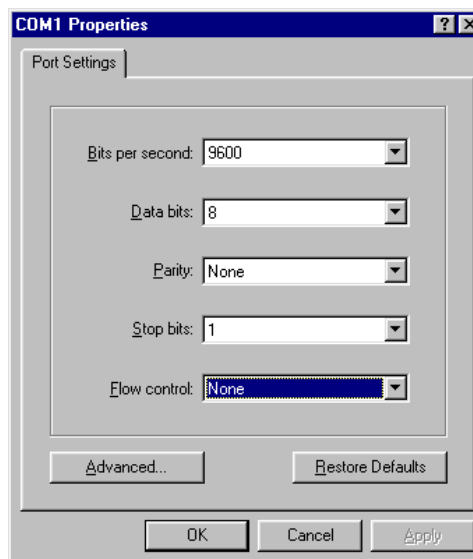

- Then set the following COM parameters: Bits per second = 9600; Data bits = 8; Parity = None; Stop Bits = 1; Flow Control = None.

- Selecting *OK* advances you to the *COM Direct–HyperTerminal* monitoring window. Notice the connection status report in the lower left corner of the window.

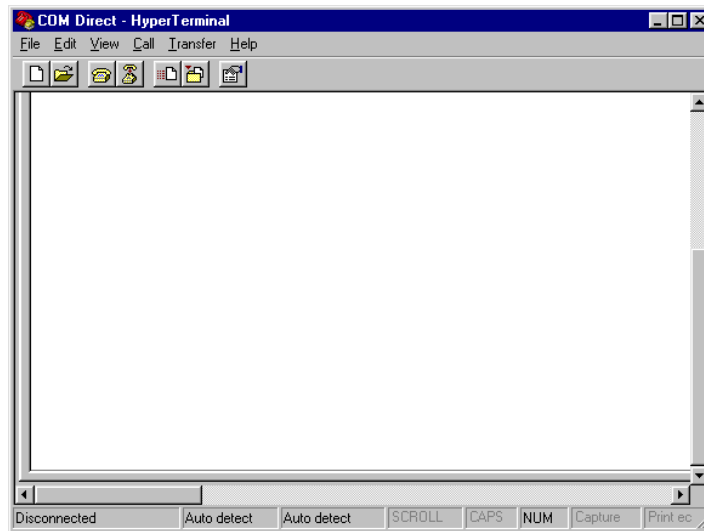

- Resetting the Development Board (at S1) will execute the *Hello.hex* file loaded into the Flash.
- Now push the <Space> bar on your keyboard once to start the automatic baud rate detection on the miniMODUL-535.
- Successful execution will send the character string "Hello World" from the target hardware to the HyperTerminal window.

Pressing any other key than the <Space> bar leads to an improper baud rate since the automatic baud rate detection is based on the timing measurement during the transmission of a well known character – the <Space> character. As a result you may get incoherent characters in the HyperTerminal window.

- Click the disconnect icon  in HyperTerminal toolbar and exit HyperTerminal.
- If no output appears in the HyperTerminal window check the power supply, the COM parameters and the RS-232 connection.

You have now successfully downloaded and executed two pre-existing example programs in Intel **.hex* file format.

3 Getting More Involved

What you will learn with this example:

- how to start the μ Vision2 tool chain
- how to configure the μ Vision2 IDE (Integrated Development Environment)
- how to modify the source code from our examples, create a new project and build and download an output **.hex* file to the target hardware

3.1 Starting the Keil μ Vision2 Tool Chain

The Keil μ Vision2 evaluation software development tool chain should have been installed during the install procedure, as described in *section 2.1*.

You can also manually install μ Vision2 by executing *ek51.exe* from within the `|Software\Keil\Ek8051` directory of your PHYTEC Spectrum CD.

Note:

It is necessary to use the Keil tool chain provided on the accompanying Spectrum CD in order to complete these QuickStart Instructions successfully. Use of a different version could lead to possible version conflicts, resulting in functional problems.

- Start the tool chain by selecting *Keil μ Vision2* from within the *Programs* group.

After you start μ Vision2, the window shown below appears. From this window you can create projects, edit files, configure tools, assemble, link and start the debugger. Other 3rd party tools such as emulators can also be started from here.

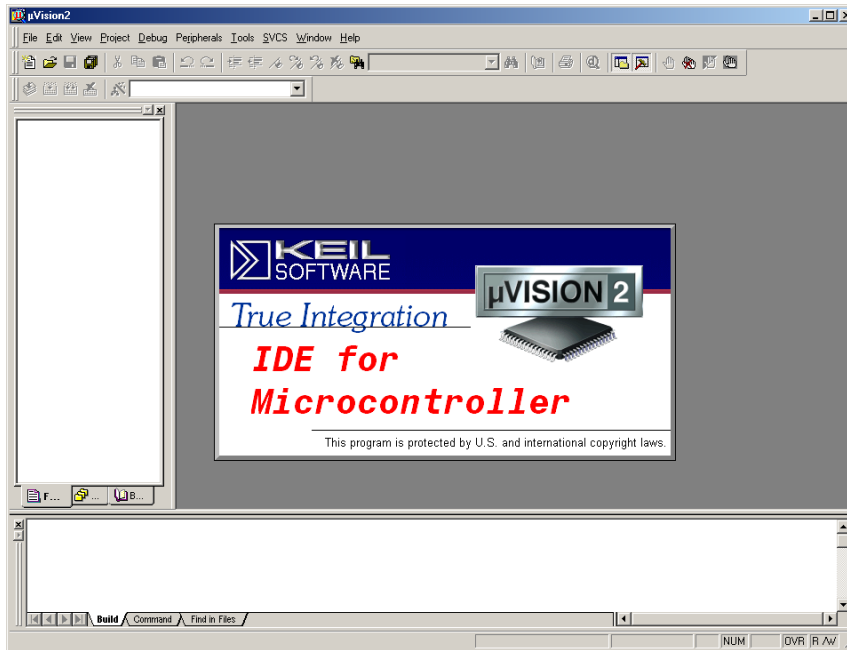

3.2 Creating a New Project and Adding an Existing Source File

μ Vision2 automatically loads the most recently opened project. If you find an existing project when starting μ Vision2, close it by selecting the *Project* menu and *Close* the project.

- To create a new project file select from the μ Vision2 menu *Project/New Project....* This opens a standard Windows dialog box that asks you for the new project file name.
- Change to the project directory created by the installation procedure (default location *C:\PHYBasic\mM-535\Demos\Keil\Blinky2*).

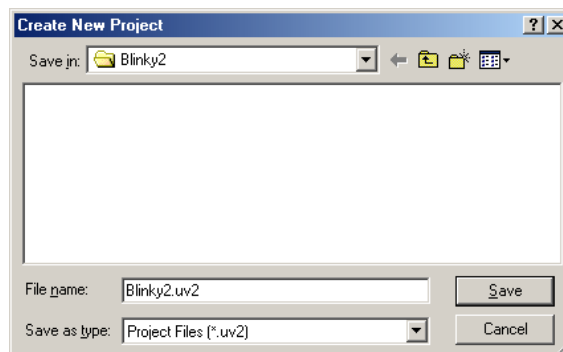

- In the text field *'File name'*, enter the file name of the project you are creating. For this example, enter the name ***Blinky2*** and click on *Save*.
- The ***Select Device for Target 'Target 1'*** window will appear. Double-click on *Infineon* in the CPU vendor data base list. The miniMODUL-535 is equipped with a *SAB 80C535*. Choose this controller type from the list as shown below. This selection sets necessary tool options for the *SAB 80C535* device, as well as pre-configures additional settings for the device.

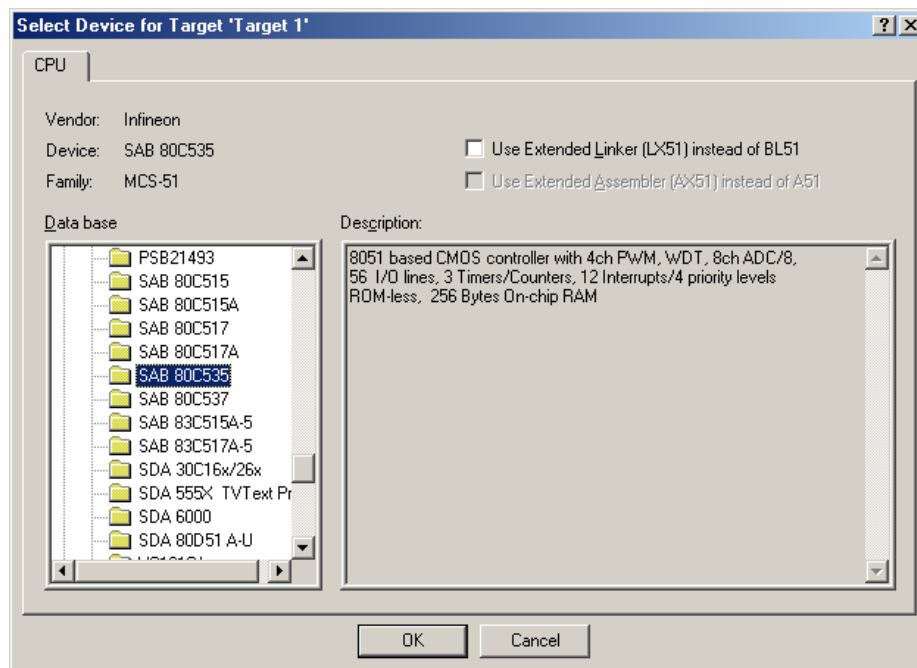

- Click on *OK*.

- Now click on *Target1* within the **Project Window - Files** tab. *Target1* is now highlighted. Click on *Target1* again to enable the edit mode. Change the default name of the target to *mM-535* and press the <Enter> key.

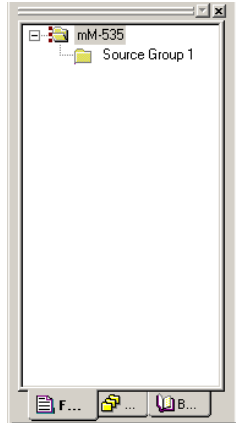

- Select the file group *Source Group 1* in the **Project Window - Files** tab and click on it to change the name into *User*.
- Right-click in the **Project Window - Files** to open a new window. Choose the option *Targets, Groups, Files...*

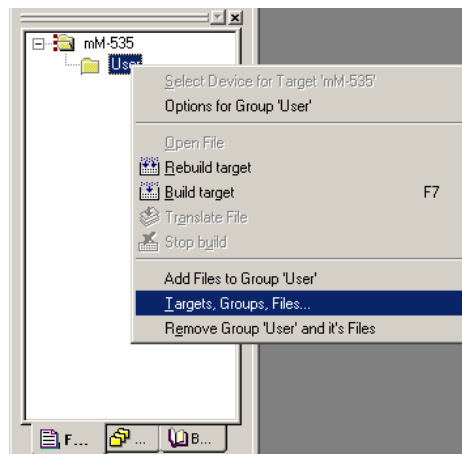

- Select the tab **Groups / Add Files** and type the new group name *System Files* in the **Group to Add:** section.

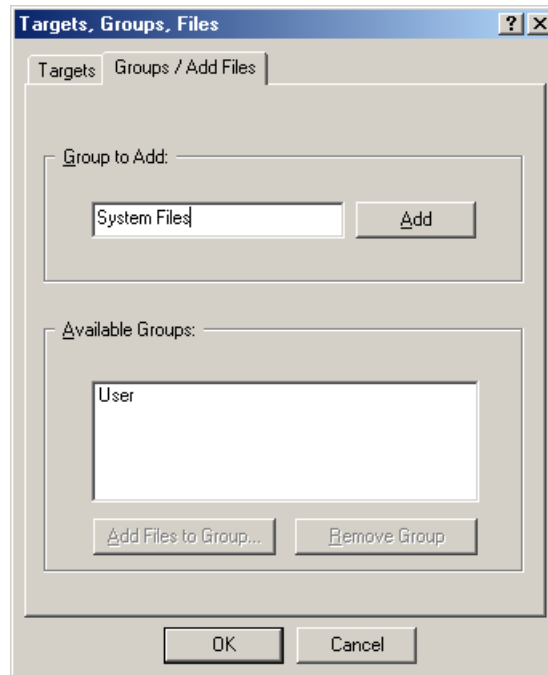

- Click on *Add* and then on *OK*.
- Your project file structure should now look like this:

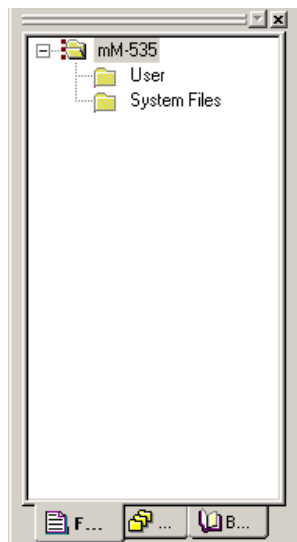

- In order to add **Blinky2.c** to our project right-click on the *User* group to open a menu. Select the option **Add Files to Group 'User'** to open the standard files dialog.

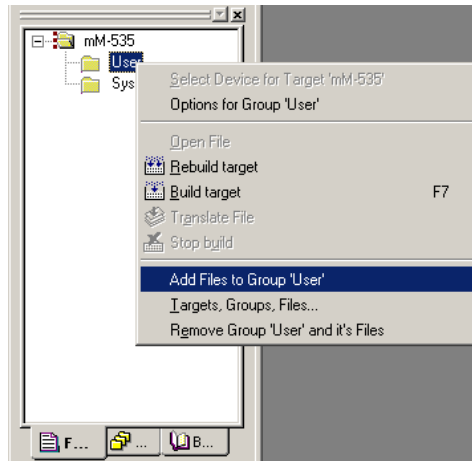

- Select the file **Blinky2.c**.

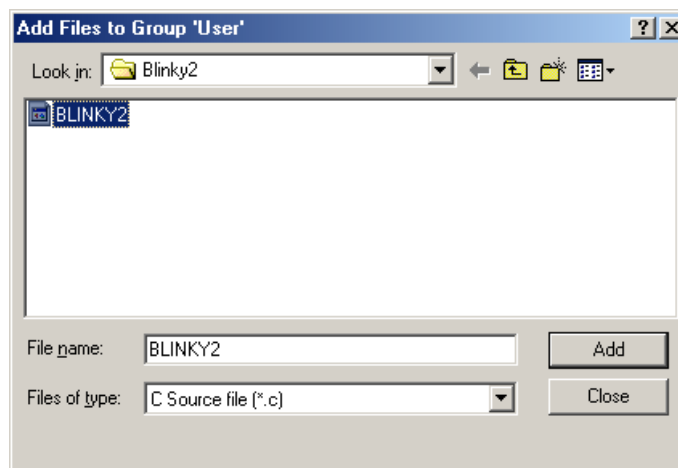

- Click on the *Add* button to add the **Blinky2.c** file to your current project window.
- Close the window.
- Now right-click on group *System Files* and add the file **Startup.a51**. You have to change the file type to "*Asm Source file (*.a, *.src)*" in the *File of types* pull-down menu to see this file.

- Your project window should now look like this:



At this point you have created a project called *Blinky2.uv2* and added an existing C source file called *Blinky2.c* and an existing assembler file called *Startup.a51*.

The next step is to modify the C source before building your project. This includes compiling, linking, locating and creating the hexfile.

3.3 Modifying the Source Code

- Double-click on *Blinky2.c* to open it in the source code editor.

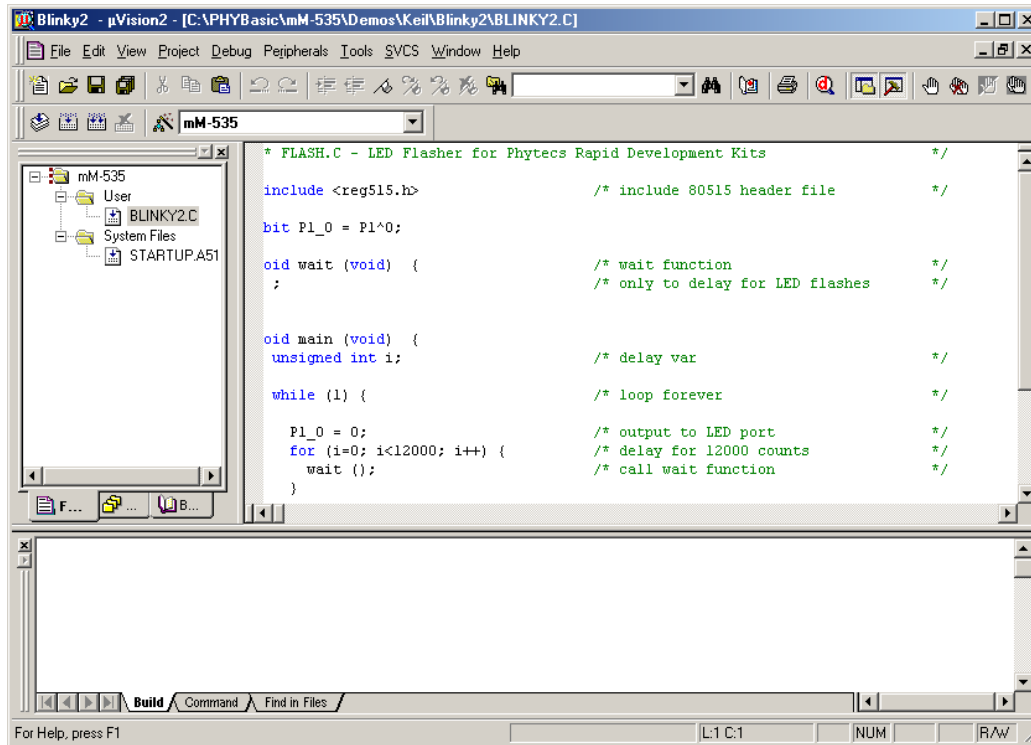

- Locate the following code section. Modify the section shown below (the values shown in bold and italic) from the original (12,000) counts to the indicated values:

```

while (1) { /* loop forever */

P1_0 = 0; /* output to LED port */
for (i=0; i<18000; i++) { /* delay for 18000 counts */
wait (); /* call wait function */
}

P1_0 = 1; /* output to LED port */
for (i=0; i<6000; i++) { /* delay for 6000 counts */
wait (); /* call wait function */
}
}
    
```

This will change the LED on/off ratio.

3.4 Saving the Modifications

- Save the modified file by choosing *File/Save* or by clicking the floppy disk icon  .

3.5 Setting Tool Chain Options

Keil includes a Make utility that can control compiling and linking source files in several programming languages. Before using the Make utility, macroassembler, C compiler or linker you must configure the corresponding options. Most of the options are set by specifying the device for the project. Only the external memory and output options must be set.

Enter the changes as indicated below and leave all other options set to their default values. μ Vision2 allows you to set various options with mouse clicks and these are all saved in your project file.



- Select the target *mM-535* within the project window.

To configure the Target:

- Open the *Project/Options for Target 'mM-535'* menu and change the default settings to the correct values for the miniMODUL-535 as shown in the figure below. This includes settings for the clock frequency of your miniMODUL, the memory model and the off-chip memory.

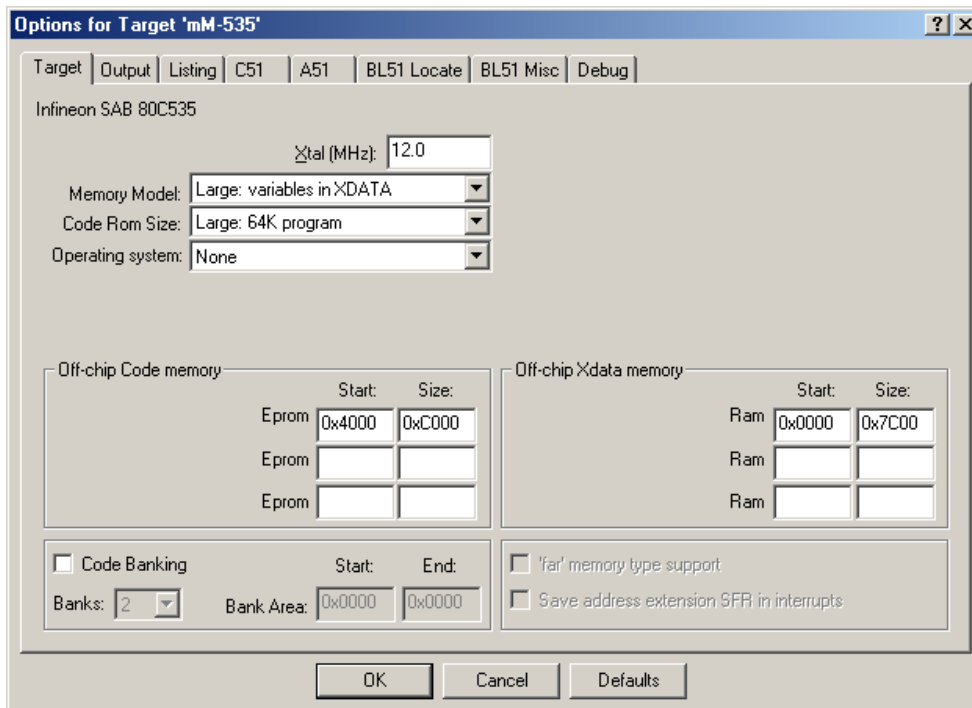

- The standard miniMODUL-535 is populated with a 32 kByte linear accessible SRAM device. This allows selection of the *Large: variables in XDATA* memory model.

The evaluation version of the Keil tool chain automatically relocates CODE to start address 0x4000¹. The XDATA memory can be configured in the range starting at 0x0000 with a maximum size of 0x7C00. The memory range between 0xFC00 and 0xFFFF is reserved for the address decoder registers and the I/O Chip Select signals on the miniMODUL-535. This address range may not be used as XDATA memory.

¹: Even if a lower start address is configured in the target code memory dialog, the linker will automatically relocate the CODE sections to 0x4000 in the Keil μ Vision2 evaluation version.

To configure the Output options:

- Select the *Output* tab and activate the *Create HEX File* checkbox. With this option an Intel **.hex* file will be created for download.

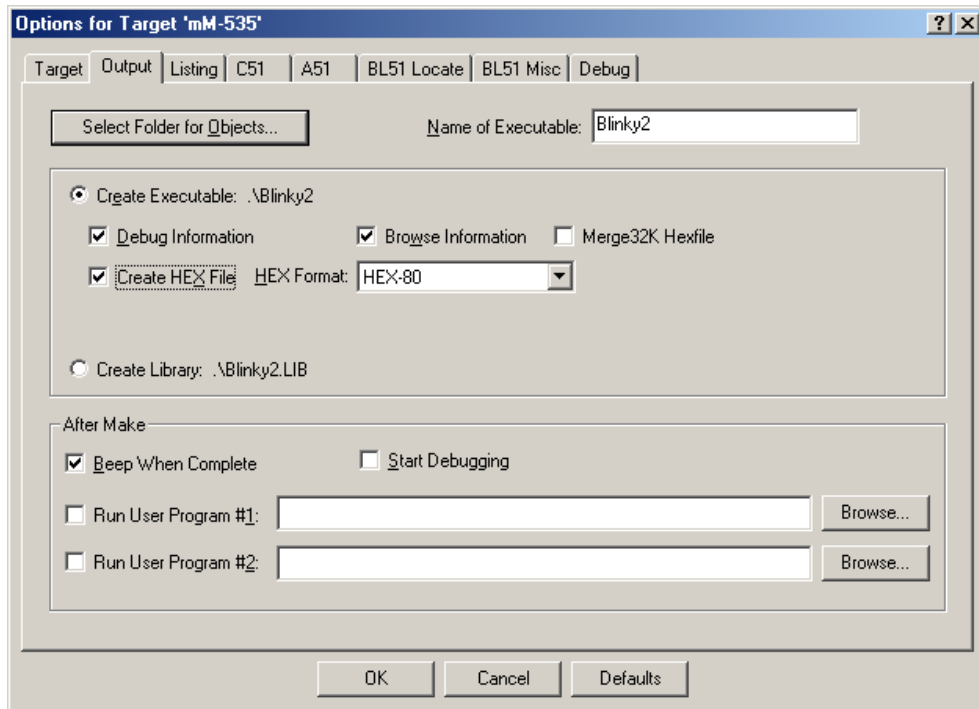

- Click on *OK*.

3.6 Building the Project

You are now ready to run the compiler and linker using the Make utility.

- Click on the *Build Target* icon  from the μ Vision2 toolbar or press <F7>.

If the program specified (*Blinky2.c*) contains any errors, they will be shown in an error dialog box on the screen.

If there are no errors, the code is compiled and linked and the executable code is ready to be downloaded to the module. This is shown in the *Output Window*, which indicates "*Blinky2*" - 0 Errors, 0 Warnings. The created hexfile will have the name of the project with *.hex* as the filename extension (in this case *Blinky2.hex*).

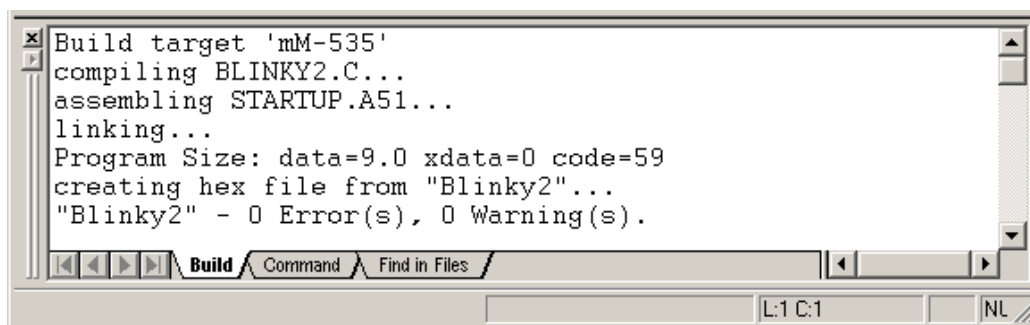

```
Build target 'mM-535'  
compiling BLINKY2.C...  
assembling STARTUP.A51...  
linking...  
Program Size: data=9.0 xdata=0 code=59  
creating hex file from "Blinky2"...  
"Blinky2" - 0 Error(s), 0 Warning(s).
```

Note:

A machine-readable, executable hexfile has been created. Other files (e.g. list files **.lst* and map files **.map*) are generated to help the debugging or troubleshooting and error searching process.

- If a list of errors appears, use the editor to correct the error(s) in the source code, save the file and (re-)build the project.

3.7 Downloading the Output File

- Exit Keil μ Vision2.
- Reset the target hardware and force it into Flash programming mode by simultaneously pressing the Reset (S1) and Boot (S2) buttons on the Development Board and then releasing first the Reset and, two or three seconds later, the Boot button.
- Start FlashTools98.
- At the *Communication Setup* tab of the FlashTools98 tabsheet, specify the proper serial port and transmission speed (9,600 Baud) for communication between host-PC and target hardware and click the *Connect* button to establish connection to the target hardware.
- Returning to the FlashTools98 tabsheet, choose the *Bank Utilities* tab, highlight *Bank #1* within the *Bank Erase* section, and click on the *Erase Bank(s)* button to erase this memory bank.
- Wait until the status check in the lower left corner of the FlashTools98 tabsheet finishes, returning the connection properties description to the lower left corner of the window.
- Next choose the *File Download* tab and click on the *File Open* button.
- Browse to the correct drive and path for the miniMODUL-535 Demo folder (default location
C:\PHYBasic\mM-535\Demos\Keil\Blinky2\Blinky2.hex
and click *Open*.
- Click on the *Download* button and view the download procedure in the status window.
- Returning to the *Communication* tab, click on the *Disconnect* button and exit FlashTools98.
- Press the Reset button (S1) on the Development Board.

If the modified hexfile properly executes, the LED should now flash in a different mode with different on and off ratio.

You have now modified source code, recompiled the code, created a modified downloadable hexfile, and successfully executed this modified code.

3.8 "Hello2"

A return to the "Hello" program allows a review of how to modify source code, create and build a new project, and download the resulting output file from the host-PC to the target hardware. For detailed commentary on each step, described below in concise form, refer back to the "Blinky2" example starting at section 3.1.

3.8.1 Creating a New Project

- Start the Keil μ Vision2 environment and close all projects that might be open.
- Open the **Project** menu and create a new project called **Hello2.uv2** within the existing project folder **C:\PHYBasic\mM-535\Demos\Keil\Hello2** (default location) on your hard-drive. Select the Infineon SAB 80C535 in the CPU vendor data base list.
- Add **Hello2.c**, **Serinit.lib** and **Startup.a51** from within the project folder to the project **Hello2.uv2**.
- Your project window should now look like this:

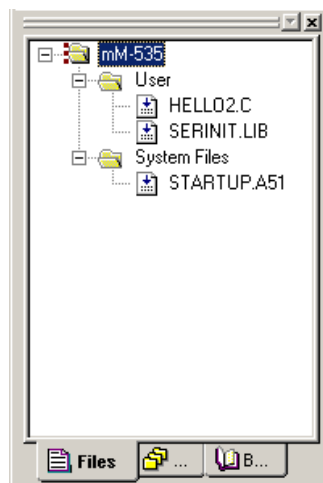

- Save the project.

At this point you have created a project called **Hello2.uv2** consisting of a C source file called **Hello2.c**, a library called **Serinit.lib** and an assembler file called **Startup.a51**.

3.8.2 Modifying the Example Source

- Double-click the file *Hello2.c* from within the project window.
- Use the editor to modify the *printf* command:

```
printf ("\x1AHello World\n")
```

to

```
printf ("\x1APHYTEC... Stick It In!\n")
```

- Save the modified file under the same name *Hello2.c*.

3.8.3 Setting Tool Chain Options

- Open the *Project/Options for Target...* menu and change the default settings to the correct values as shown in *section 3.5*. This includes settings for the clock frequency of your miniMODUL, the memory model (make sure "*Large: variables in XDATA*" is configured) and the off-chip memory.
- Modify the default options for the output file by selecting the *Create HEX File* checkbox in the *Project/Options for Target.../Output* tab. This will automatically create a hexfile for download to the miniMODUL-535 after compiling.

3.8.4 Building the New Project

- Build the project.
- If any source file in the project contains errors, they will be shown in an error dialog box on the screen. Use the editor to correct the error(s) in the source code, save the file and (re-)build the project.

If there are no errors, the code is assembled and linked and the executable code is ready to be downloaded to the board.

3.8.5 Downloading the Output File

- Exit Keil μ Vision2.
- Reset the target hardware and force it into Flash programming mode by simultaneously pressing the Reset (S1) and Boot (S2) buttons on the Development Board and then releasing first the Reset and, two or three seconds later, the Boot button.
- Start FlashTools98.
- At the *Communication Setup* tab of the FlashTools98 tabsheet, specify the proper serial port and transmission speed (9,600 baud) for communication between host-PC and target hardware and click the *Connect* button to establish connection to the target hardware.
- Returning to the FlashTools98 tabsheet, choose the *Bank Utilities* tab, highlight *Bank #1* within the *Bank Erase* section, and click on the *Erase Bank(s)* button to erase this memory bank.
- Wait until the status check in the lower left corner of the FlashTools98 tabsheet finishes, returning the connection properties description to the lower left corner of the window.
- Next choose the *File Download* tab and click on the *File Open* button.
- Browse to the correct drive and path for the miniMODUL-535 demo folder (default location ***C:\PHYBasic\mM-535\Demos\Keil\Hello2\Hello2.hex*** directory (default location).
- Click on the *Download* button and view the download procedure in the status window.
- Returning to the *Communication* tabsheet, click on the *Disconnect* button and exit FlashTools98.

3.8.6 Starting the Terminal Emulation Program

- Start HyperTerminal and open a session using the following COM parameters: Bits per second = *9600*; Data bits = *8*; Parity = *None*; Stop Bits = *1*; Flow Control = *None*
- Resetting the Development Board (at S1) will execute the ***Hello2.hex*** file loaded into the Flash.
- Press the <Space> bar on the keyboard to proceed the automatic baud rate detection
- Successful execution will send the character string "***PHYTEC... Stick It In!***" from the target hardware to the HyperTerminal window

You have now modified source code, recompiled the code, created a modified download hex-file, and successfully executed this modified code.

4 Debugging

This Debugging section provides a basic introduction to the debug functions included in the Keil software evaluation development tool chain. Using an existing example, the more important features are described. For a more detailed description of the debugging features, please refer to the appropriate manuals provided by Keil.

The μ Vision2 Debugger offers two operating modes that can be selected in the *Project/Options for Target mM-535* dialog:

- The **Simulator** allows PC-based microcontroller simulation of most features of the 8051 microcontroller family without actually having target hardware. You can test and debug your embedded application before the hardware is ready. μ Vision2 simulates a wide variety of peripherals, including the serial port, external I/O, and timers. The peripheral set is selected when you select a CPU from the device database for your target.
- Advance GDI drivers, like the **Keil Monitor 51** interface, allow target-based debugging. With the Advanced GDI interface you may connect directly to the target hardware. Debugging on the target hardware also enables testing peripheral components.

The following examples utilize the Keil Monitor 51 interface.

Note:

Use of the monitor program requires protection (reservation) of some controller resources, such as the serial interface, the serial interrupt and timer 1. These resources are necessary to allow communication between the monitor program on the target hardware and the μ Vision2 Debugger (*refer to the Keil Getting Started Manual for further information*). Do not use these resources when developing an application program to be debugged using the Keil Monitor 51 interface.

Before using the Keil Monitor 51 interface, a special *.hex file (the monitor firmware) must be downloaded to the target hardware.

4.1 Preparing the Target Hardware to Communicate with μ Vision2 Target Monitor

- Ensure that the target hardware is properly connected to the host-PC and a power supply.
- Reset the target hardware and force it into Flash programming mode by simultaneously pressing the Reset (S1) and Boot (S2) buttons on the Development Board and then releasing first the Reset and, two or three seconds later, the Boot button.
- Start FlashTools98 for Windows.
- At the *Serial Interface* tab of the FlashTools98 tabsheet, specify the proper serial port and transmission speed for communication between host-PC and target hardware and click the *Connect* button to establish connection to the target hardware.
- Returning to the FlashTools98 tabsheet, choose the *Bank Utilities* tab, highlight *Banks #1* and click on the *Erase Bank(s)* button.
- Next choose the *File Download* tab and click on the *File Open* button.
- Download the file *mon51.hex* from the *Tools* folder *C:\PHYBasic\mM-535\Tools\Keil\Mon\32k* (default location).

The PHYTEC Spectrum CD-ROM may also contain other versions of the *mon51.hex* monitor file. These versions are made for different oscillator frequencies and memory options of the miniMODUL-535. The files are available in *C:\PHYBasic\mM-535\Tools\Keil\Mon* within various subdirectories. *Please refer to readme files within the directories for details.*

- Click on the *Download* button and view the download procedure in the status window.

If download is successful, the monitor kernel has been programmed into the external Flash memory. The target hardware is now prepared to communicate with the Keil μ Vision2 debugging tools installed on the host-PC.

- Disconnect from the target hardware after the download has finished either by clicking the *Disconnect* button on the *Communication Setup* tabsheet or choosing the *Connect/Disconnect* icon from the FlashTools98 toolbar.
- Exit FlashTools98.

4.2 Creating a Debug Project and Preparing the Debugger

4.2.1 Creating a New Project

- Start the Keil μ Vision2 environment and close all projects that might be open.
- Open the Project menu and create a new project called *Debug.uv2* within the existing project directory
C:\PHYBasic\mM-535\Demos\Keil\Debug
(default location) on your hard drive. Select the Infineon SAB 80C535 in the CPU vendor data base list.
- Rename the target of your project within the **Project Window – Files** tab into *mM-535*.
- Rename the file group *Source Group 1* within the **Project Window – Files** tab into *User* and add an additional file group named *System Files*.
- Add *Debug.c* and *Serinit.lib* to the file group *User* and *Startup.a51* to the file group *System Files* from within the project folder.
- Your project should now look like this:

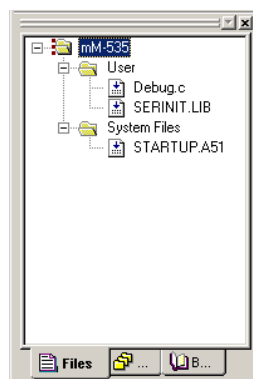

- Save the project.

At this point you have created a project called ***Debug.uv2***, consisting of a C source file called ***Debug.c***, the ***Serinit.lib*** library file and the assembler file ***Startup.a51***. The ***Serinit.lib*** library file contains functions for the serial communication between the target hardware and the host-PC as well as the automatic baudrate detection feature.

4.2.2 Setting Options for Target

When setting the memory configuration, the memory layout necessary for the monitor must be taken into consideration.

The standard 8051 controller uses a Harvard memory architecture. In this architecture, access to CODE and XDATA memory space goes to physically different memory devices. Normally, for access to CODE space, a non-volatile memory is utilized, i.e. ROM or Flash. For access to XDATA space, a RAM is used. Using this memory model with an 8051 derivative allows access to up to 64 kByte of memory for CODE and 64 kByte for XDATA.

When debugging with the Keil monitor, it is important that the user program (CODE) can be changed during runtime (e.g. to enable setting of breakpoints). This requires the user program to be stored in RAM and **not** in Flash. In order to ensure that the user program is running in RAM, the monitor automatically configures a von Neumann memory architecture in the address range 0000H-7FFFH after reset. Here, in contrast to the Harvard architecture, access to CODE and XDATA space is directed towards the same physical memory device, normally RAM. With this von Neumann memory architecture, it is now possible to change the application program during runtime.

The following figure (see Figure 5) depicts the memory layout that is configured by the Keil monitor for 32 kByte RAM.

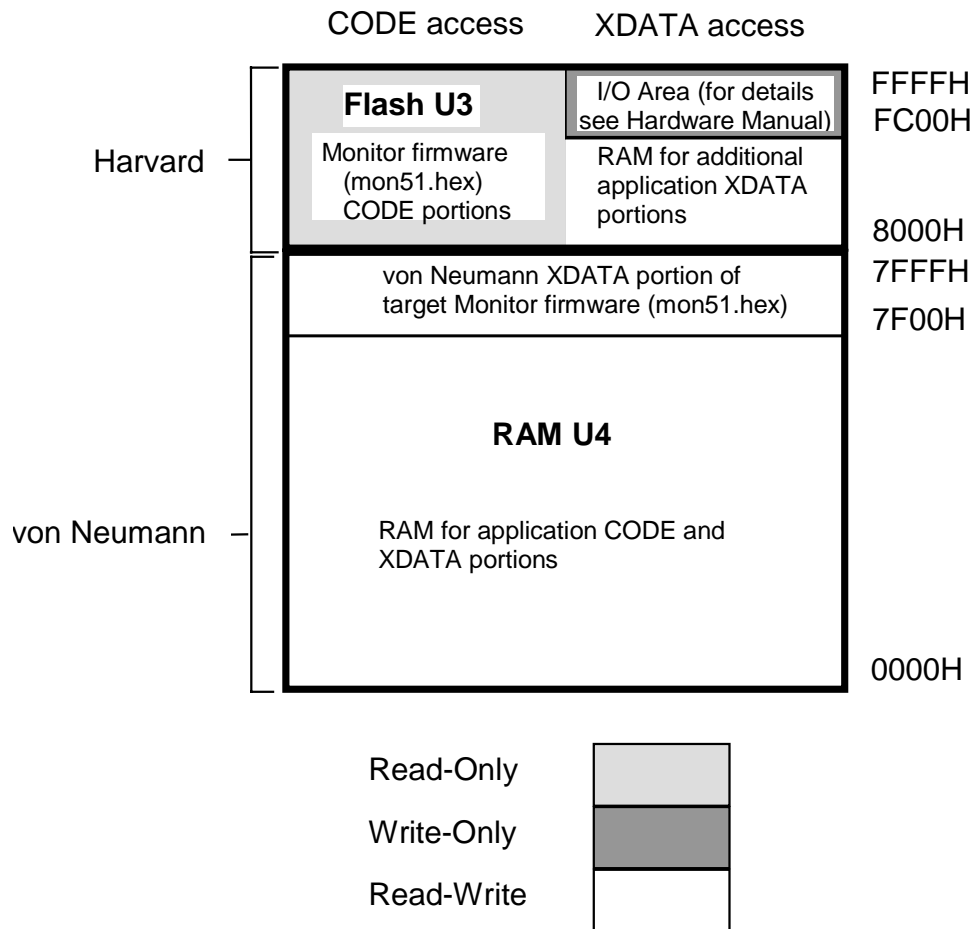
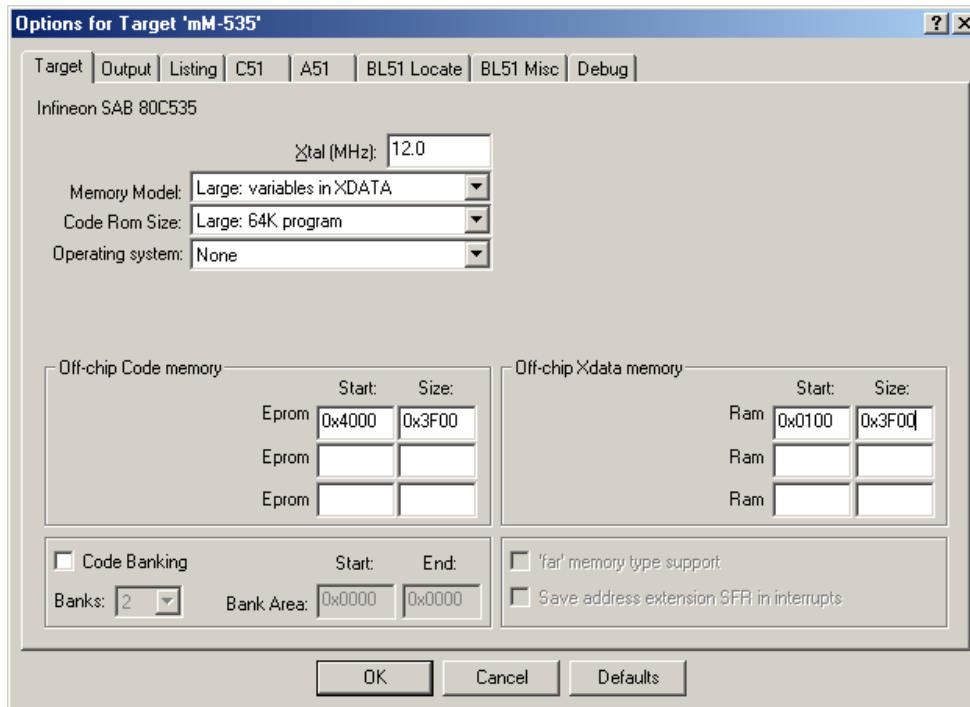

Figure 5: Memory Model for Use with the Keil Monitor (32 kByte RAM)

Note:
 When using the von Neumann memory architecture, ensure that the CODE and XDATA areas within the application program do **not** overlap. This is important because otherwise portions of the program (CODE) will be overwritten by e.g. variables (XDATA), resulting in an error when executing user code.

- Open the **Project/Options for Target 'mM-535'** menu and change the default settings to the correct values as shown in the figure below. This includes settings for the clock frequency of your miniMODUL-535, the memory model (make sure "*Large: variables in XDATA*" is configured) and the off-chip memory¹.



The memory ranges for off-chip CODE and off-chip XDATA memory are configured to fit within the von Neumann memory space as configured by the Keil *mon51.hex* monitor file (refer to Figure 5). In addition, the restrictions for the off-chip CODE memory start address in the evaluation version of the Keil tool chain must be considered. The start address of the XDATA memory should be at 0x100 in order to avoid conflicts with the interrupt/reset vector table which is located between 0x0 and 0xFF.

¹ Ensure that the CODE and XDATA memory do not overlap.

Note: When using the evaluation version of the Keil tool chain, the start address of the CODE memory must be at 0x4000 or higher. When using the full version of the Keil tool chain, the start address of the CODE memory should be at 0x100. This avoids conflicts with the interrupt/reset vector table which is located between 0x0 and 0xFF. The XDATA memory can then be located in a higher address range. Again, ensure that the CODE and XDATA memory do not overlap.

- Select the **Output** tabsheet and enable the **Browse Information** checkbox. This will include additional browser information into the object files that can be viewed with the **Source Browser** included in Keil μ Vision2.

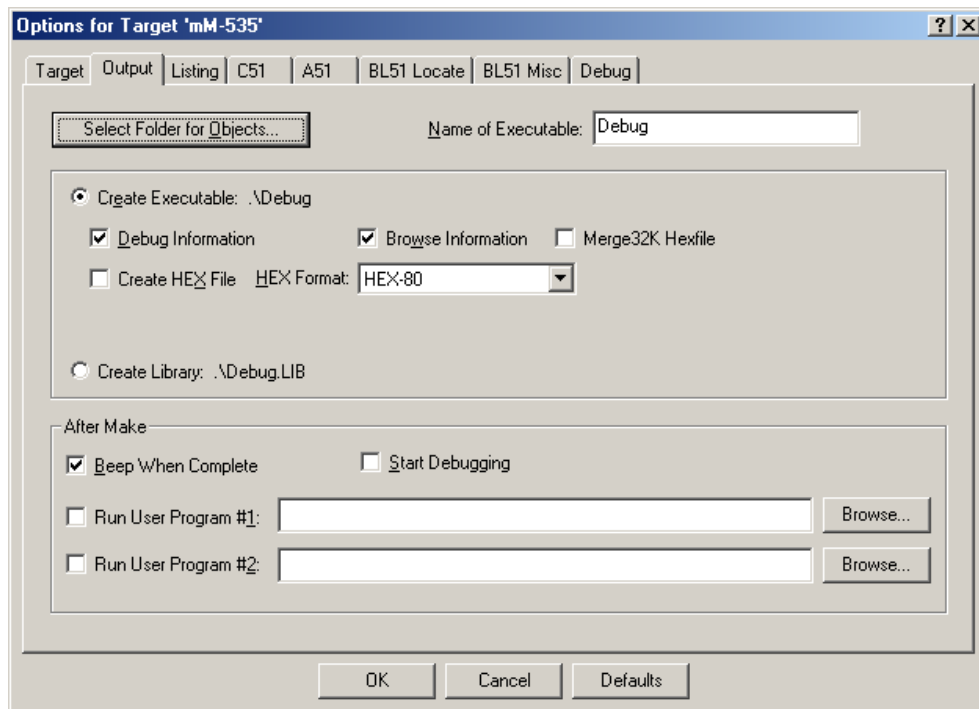

The compilation of the *Debug.c* program can be controlled with the two *define* statements **MONITOR51** and **INTERRUPT**. Setting the *define* **MONITOR51** reserves space for the serial interrupt and disables the configuration of the serial interface by the *Debug.c* program. This is necessary to avoid overwriting the configuration done by the monitor kernel. The *define* **INTERRUPT** disables all serial output of the *Debug.c* program. If debugging is controlled with the serial interrupt, (see settings for the Keil Monitor 51 Driver in section 4.3) any serial input and output of the user application conflicts with the communication of the monitor program. Such serial communication functions cannot be active in user code to ensure proper debugging.

- Select the **C51** tabsheet and add **MONITOR51** in the *Define:* input field¹. Adjust the settings for *Code Optimization* to the settings shown in the figure below.

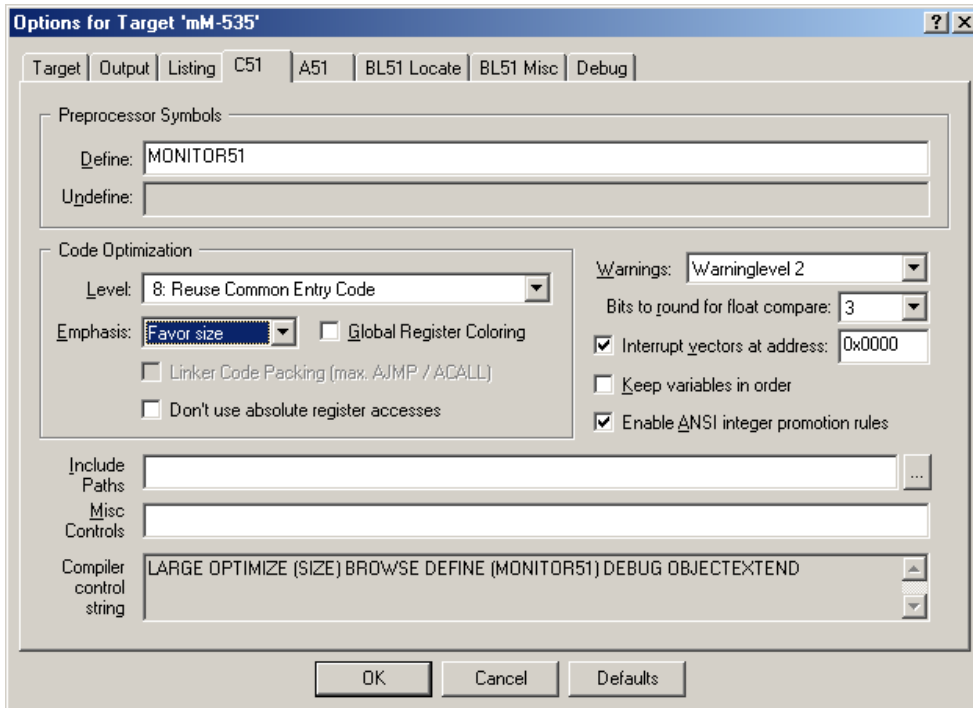

- Ensure that the configurations on the **Listing**, **A51**, **BL51 Locate** and **BL51 Misc** tabsheets are set to their default settings.
- Click the **OK** button to save the settings.
- Click on the **Rebuild all target files**  button to compile and link your project.

¹: Please note that this example only requires the *define* **MONITOR51** in order to use the serial output.

4.3 Preparing the Debugger

According to the *Project/Options for Target 'mM-535'* configuration, μ Vision2 will load the application program and run the startup code.

- Open the *Project/Options for Target 'mM-535'* menu and select the *Debug* tabsheet.
- Enable the checkboxes *Use: Keil Monitor-51 Driver* and *Load Application at Startup*. Disable the checkbox *Go till main()*.

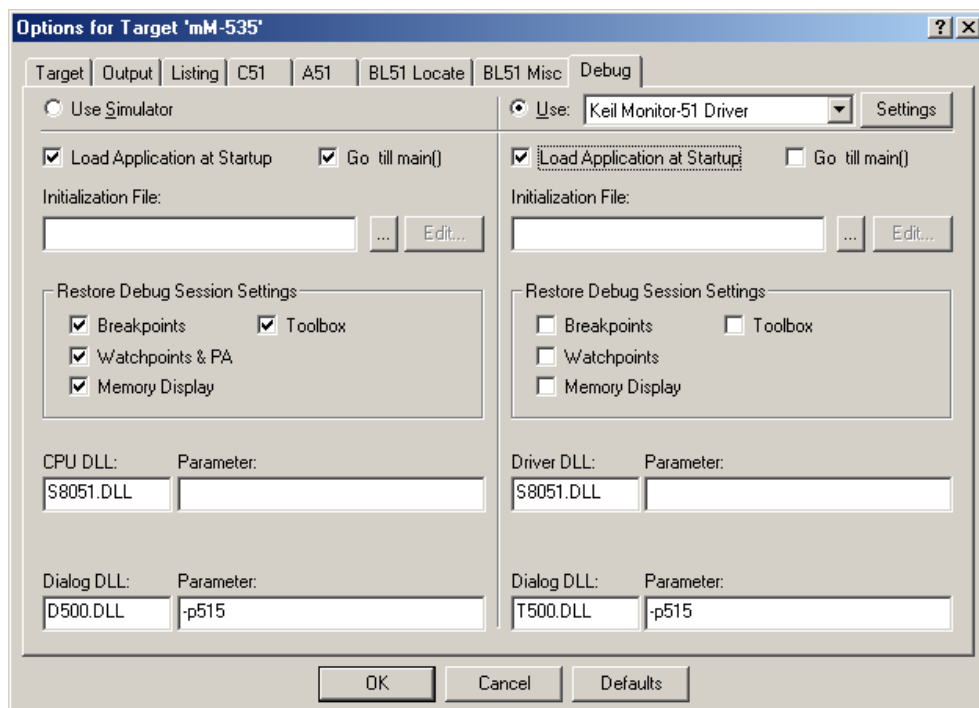

- Click on the **Settings** button in the upper right-hand corner of the **Debug** tabsheet.
- Select the correct COM port and baud rate in the *COM Port Settings* as shown below.
- Ensure that *Serial Interrupt* checkbox is disabled.

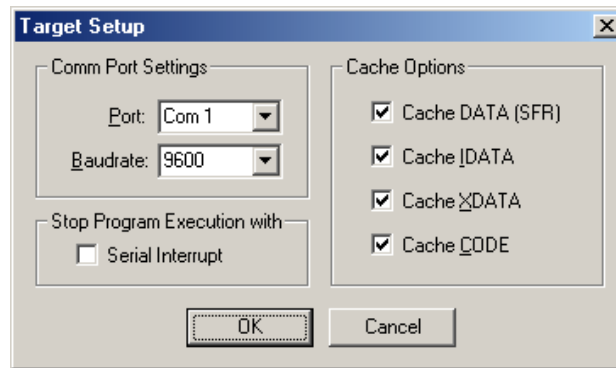

- Click on the *OK* button to exit the *Target Setup* window.

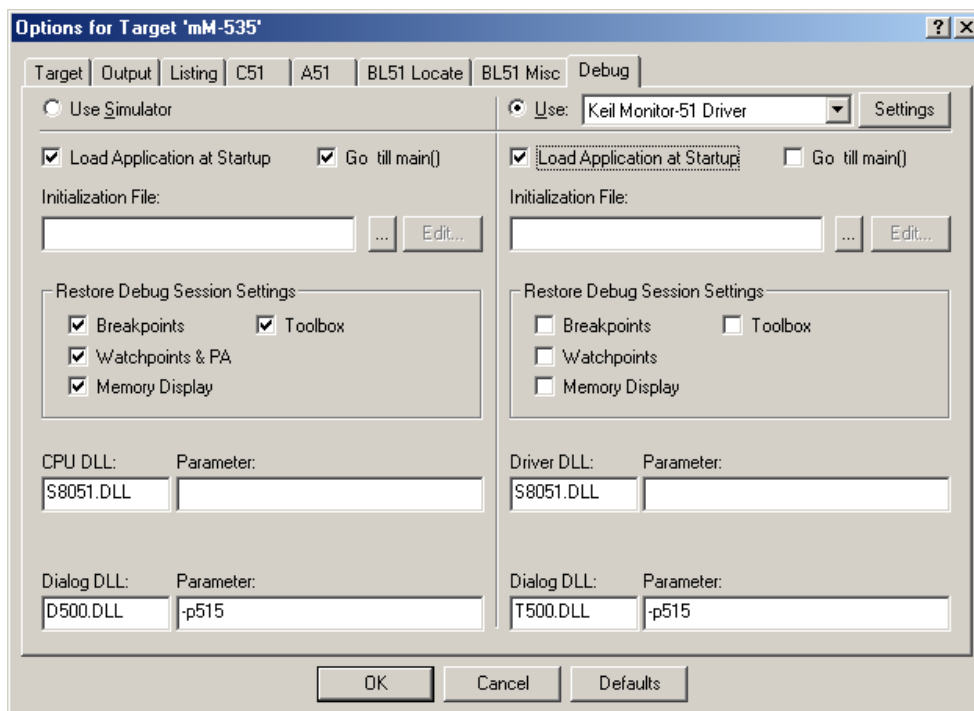

- Click on the *OK* button again.

4.4 Starting the Debugger

- Before starting the Debugger on the host-PC, press the Reset button (S1) on the Development Board to start the previously downloaded monitor kernel.
- To start the μ Vision2 debug environment, click on the debugger icon  on the μ Vision2 toolbar. A pop-up window will appear indicating that this is an evaluation version. Click on *OK*.



- You will see a blue status bar from left to right at the bottom of your screen indicating the download process of the debug program.

If a problem occurs during data transfer, the following window will appear:

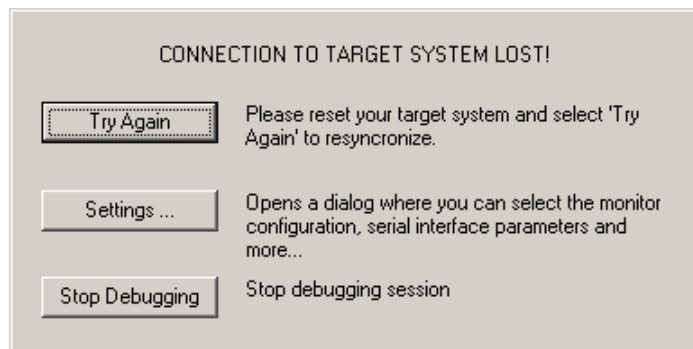

- Click on *Settings* and verify the COM port and the baud rate (9,600 baud). Push the Reset button S1 on the Development Board and click on *Try Again*.

If the data transfer was successful, a screen similar to the one shown below will appear. The **Project** window changed to the **Register** page. The debug toolbar is also displayed. The **Serial** window is located below the **Project** window. It shows all serial output of the debug program. In the lower part of the debug screen you will see the **Command**, **Memory** and **Watch/Stack** window.

You may need to open, resize and/or move some windows to make your screen look similar to the screen capture below. You can open inactive windows by choosing the desired window from the **View** pull-down menu. The following screen captures have **Workbook Mode** enabled to allow easy access to various overlapped windows with tabs.

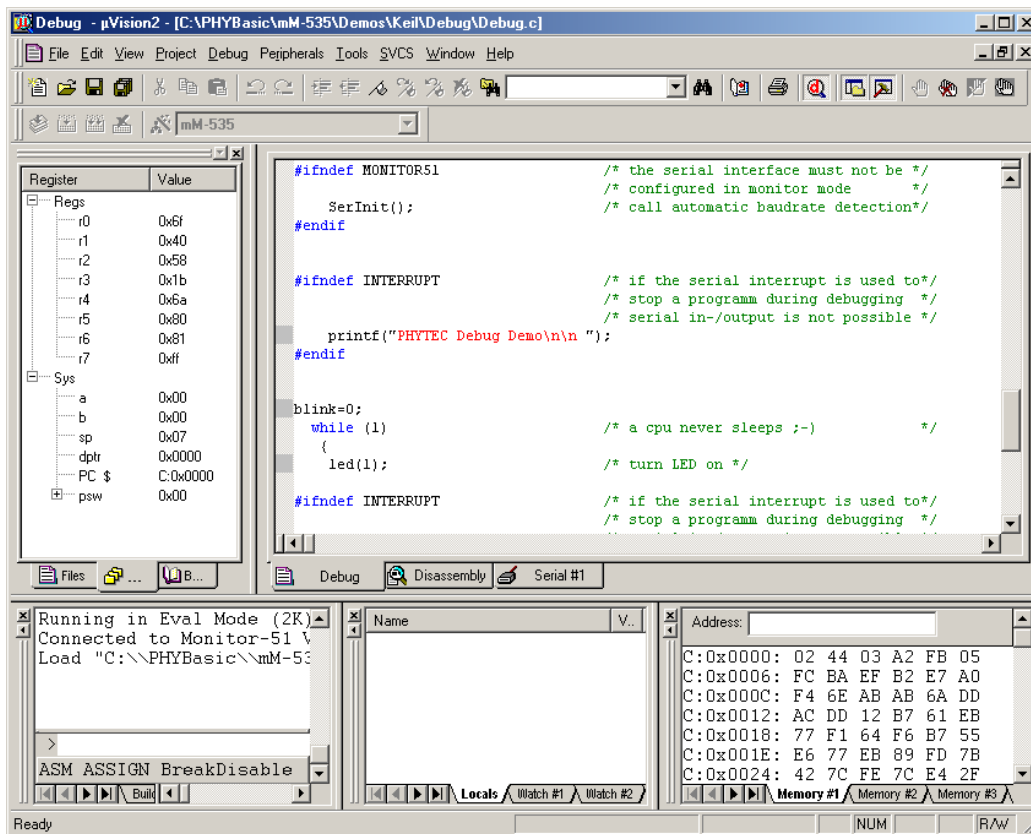

- Before starting the program, point the mouse at the *constant* named "**rhythm[]**". A small window appears and displays the address where *rhythm* is stored and its current value is shown. The *constant* is not yet initialized and the value is therefore random.

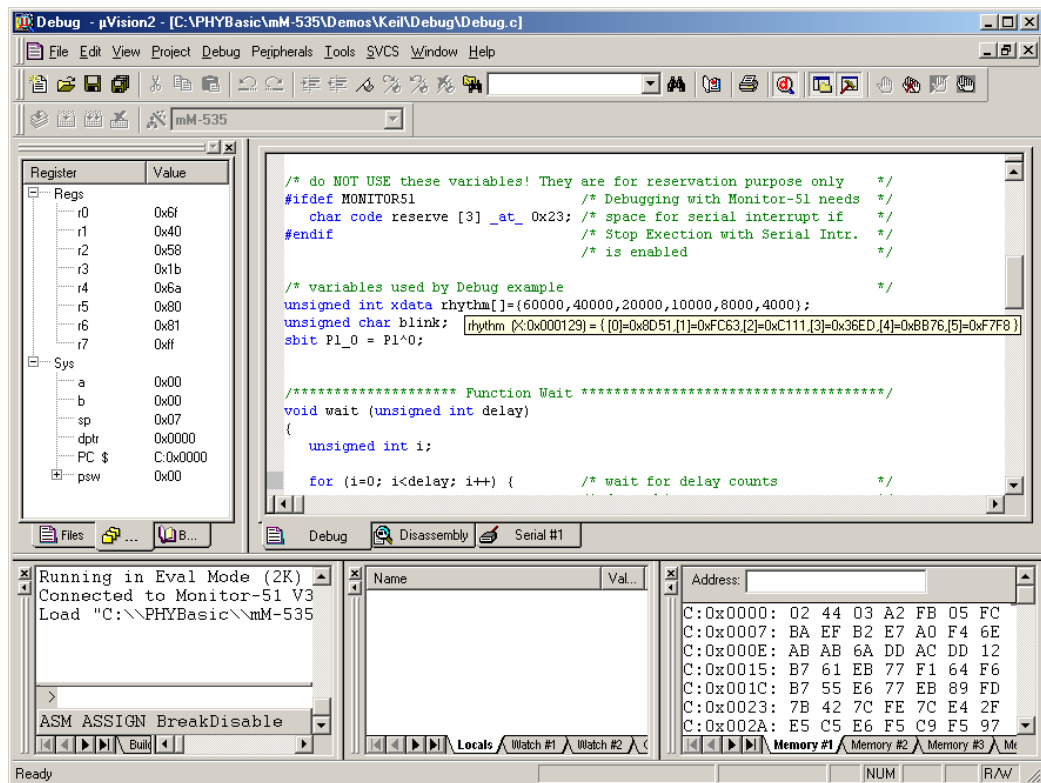



- In the **Command** window prompt in the lower left corner, type in **g,main** (notice the comma!) and press <Enter> to start the program.

The debugger will run to the 'main' function and stop automatically. Notice the yellow arrow pointing to the first command in the 'main' function. Also notice the program counter (**PC \$**) within the **Project Window – Register** page showing the start address of the 'main' function.

4.5 Keil μ Vision2 Debug Features

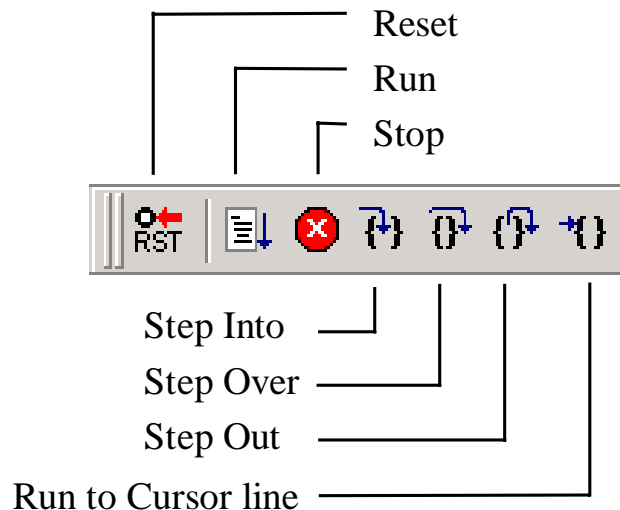
- The *Debugger* window toolbar gives access to the following debug commands: *Reset*, *Run*, *Stop*, *Step Into*, *Step Over*, *Step Out* and *Run to Cursor line*.



- The first button on the debugger toolbar is the *Reset*  button.

The *Reset* command sets the program counter to 0. However, it should be noted that peripherals and SFRs of 8051 devices are not set into reset state. Therefore this command is not identical to a hardware reset of the CPU.

- The button to the right of the *Reset* button starts the *Run*  command.

Clicking this button runs the program without active debug functions. To stop program execution at a desired point, a breakpoint can be placed before the *Run* button is pushed.

- The next button on the debugger toolbar is the *Stop*  button.

The *Stop* button interrupts and stops the running program at an undetermined location.

- The first button allowing exact control of the program execution is the *Step Into*  button.

The *Step Into* command performs the execution of the command line to which the *Current-Statement Arrow*  points. This can be a C command line or a single assembler line, depending on the current display mode. If the command line is a function call, *Step Into* jumps to the C function or subroutine, enabling you to explore the code contained in the accessed subroutine.

- The *Step Over*  button is next on the debugger toolbar.

The *Step Over* command executes the command line, to which the *Current-Statement Arrow*  points. This can be a C command line or a single assembler line, depending on the current display mode. If the command line is a function call, the function will be executed without single stepping into the function.

Note:

We recommend not using the *Step Over* function with the monitor. During compiling of the C code, the compiler runs through the optimization steps. This optimization summarizes calls of nested functions and their return jump to the original function in the compiled machine code. This can effect a *Step Over* command by nesting multiple calls for sequential functions. For users with assembler knowledge, the *View->Disassembly* window is recommended. Here the C source code contrasts with the machine code and the optimization steps are obvious.

- The next button is the *Step Out*  button.

Step Out is used to exit a function you are currently in. *Step Out* is very useful if you find yourself in a function you are not interested in and need to return quickly to your intended function.

Note:

Due to performance reasons the *Step Out* command is not available in monitor mode. *Step Out* is only available in the simulator mode.

- The last button  on the debugger toolbar performs the *Run to Cursor line* command.

The *Run to Cursor line* command executes the program to the current cursor position within the code window. This allows use of the cursor line as a temporary breakpoint.

4.6 Using the Keil μ Vision2 Debug Features

4.6.1 Serial Window

- Click on the *Step Into*  button. The **printf** command will be executed and the serial output will appear in the *Serial #1* window of the debugger.

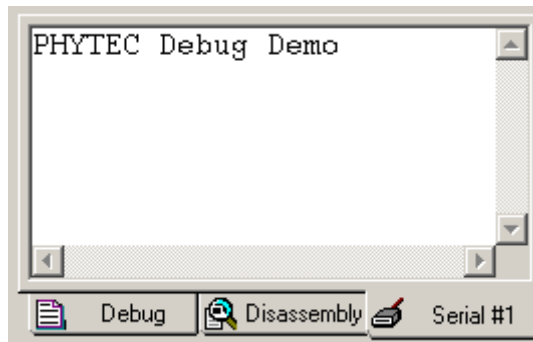

4.6.2 Breakpoints

- Click in the line where the 'wait' function is called for the first time.
- Click on *Insert/Remove Breakpoint*  to set a breakpoint here. The red marker on the left-hand side of the selected line indicates the breakpoint.

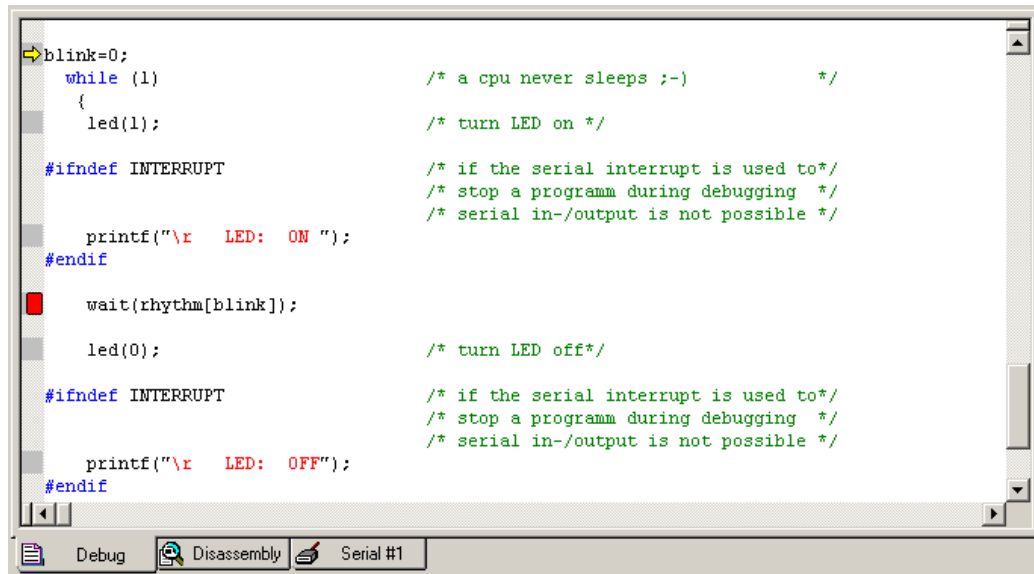



```

blink=0;
while (1)                                /* a cpu never sleeps ;- )      */
{
    led(1);                                /* turn LED on */
#ifdef INTERRUPT                          /* if the serial interrupt is used to*/
/* stop a programm during debugging */
/* serial in-/output is not possible */
    printf("\r LED: ON ");
#endif
    wait(rhythm[blink]);
    led(0);                                /* turn LED off*/
#ifdef INTERRUPT                          /* if the serial interrupt is used to*/
/* stop a programm during debugging */
/* serial in-/output is not possible */
    printf("\r LED: OFF");
#endif
}

```

The screenshot shows a code editor window with a red square breakpoint marker on the line `wait(rhythm[blink]);`. The editor has a toolbar at the bottom with buttons for 'Debug', 'Disassembly', and 'Serial #1'.

- Click on the *Run*  icon and the program will run and stop at the breakpoint.
- Notice that the LED (D3) on the Development Board now illuminates. This is because the `led(1)` function call has been executed and the status of the LED is shown in the *Serial* window.
- Click again on *Insert/Remove Breakpoint*  to remove the breakpoint.

4.6.3 Single Stepping and Watch Window

- Click on the **Step Into**  icon to enter the 'wait' function.
- The **Watch** window automatically shows the value of the two local variables; *delay* and *i*. In order to change the number base from hexadecimal to decimal, right-click on the variable you want to change.

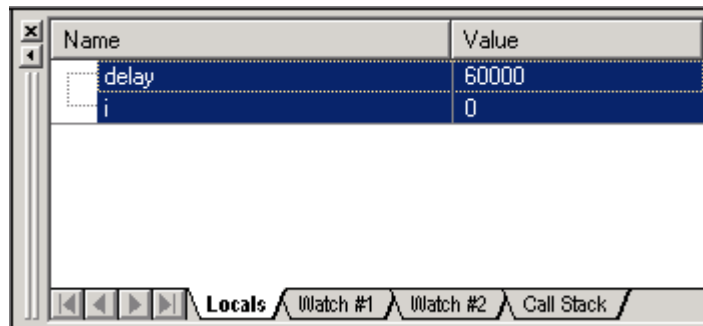

- Click **Step Into** several times and watch the value of *i* count up.
- As you can see in the source code, the for{ } loop will end if *i* becomes equal to *delay*. To leave the *wait* function, change the value of *i* by typing ***i=59996*** in the command line and pressing <Enter>. Now repeat clicking on **Step Into** until you leave the wait

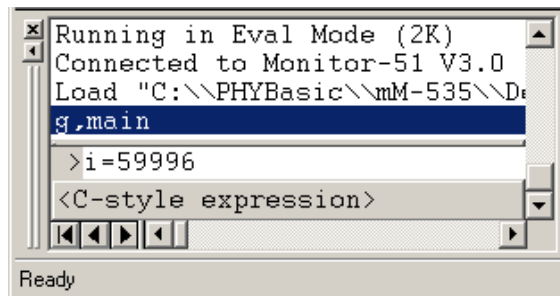

function.

- Click in the source code line *blink++* and choose **Run to Cursor line** from the debug toolbar. Your program will be executed until it reaches this line.
- Notice that the LED D3 on the Development Board is off now and the new status of the LED is shown in the **Serial** window.

- As a last example, the constant "**rhythm[]**" will be evaluated. Go to the source code line where the constant "**rhythm[]**" is declared. Right-click on "**rhythm[]**" and choose the "**ADD rhythm to watch window**" -> #1 option. Select the "**Watch #1**" tabsheet at the bottom of the watch window. The constant is shown with its address and a small \oplus sign in front which indicates that "**rhythm[]**" is an array with a group of array elements. Click the \oplus sign to expand the view and to see all array elements of "**rhythm[]**".

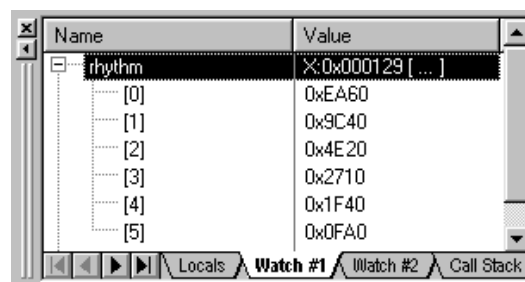

Using the memory address of *rhythm*, which is shown in the watch window, it is also possible to view the values of the array elements in the **Memory** window.

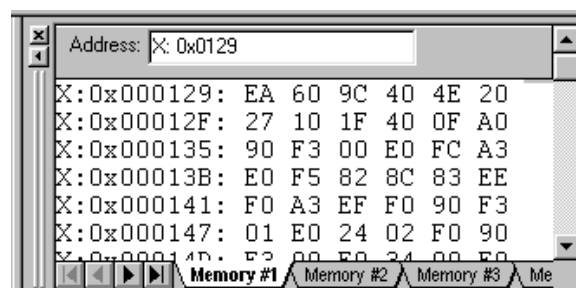

- Type X: 0x0129 in the *Address:* line of the **Memory** window and press <Enter>.

A memory area starting at address 0x0129 of the external memory is now displayed in the **Memory** window.





- The passing of the array element to the wait function can be viewed whenever you step into the wait function. After stepping into the wait function you will find one of the elements in registers R6 and R7.

4.7 Running, Stopping and Resetting

- To run your program without stopping at any time, delete all breakpoints by clicking on the  button.
- Click the **Run**  button.

The LED now blinks and its current status is displayed in the *Serial* window.

Use of the **Stop**  button is not possible as this example utilizes functions for the RS-232 communication within the application code. To stop program execution, leave the debugger and press the Reset button on the Development Board.

If you want to use the **Stop**  button, the serial output of the debug program must be disabled. To do so, add **INTERRUPT** in the *Define:* input field within the *C51* tabsheet before rebuilding the project and enable the *Serial Interrupt* in the *Target Setup* window for the debugger.

4.8 Changing Target Settings for the "Final Version"

After successfully debugging the program, next change the target settings in order to create an Intel hexfile. This can then be downloaded to the Flash memory of the miniMODUL-535.

- Open the *Project/Options for Target 'mM-535'* menu and change the settings for off-chip memory to the new values as shown in the figure below. Since this program code is intended for execution out of Flash rather than running in the Keil *mon51.hex* monitor, the complete range of available memory can be used.

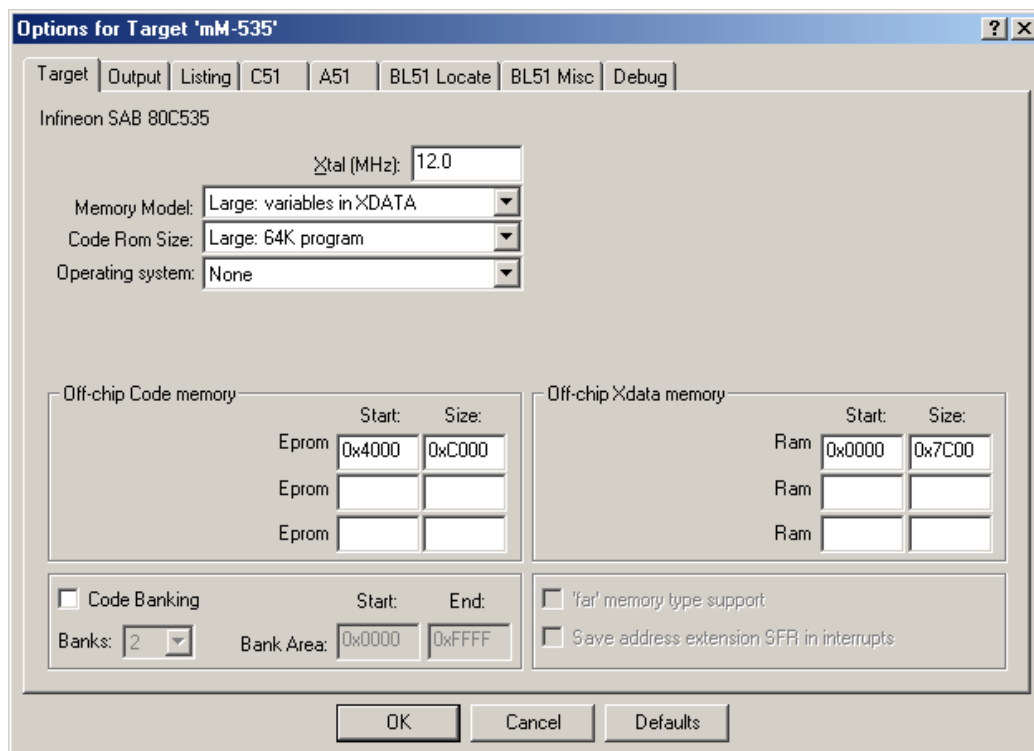

- Select the **Output** tabsheet and enable the checkbox *Create HEX File*.

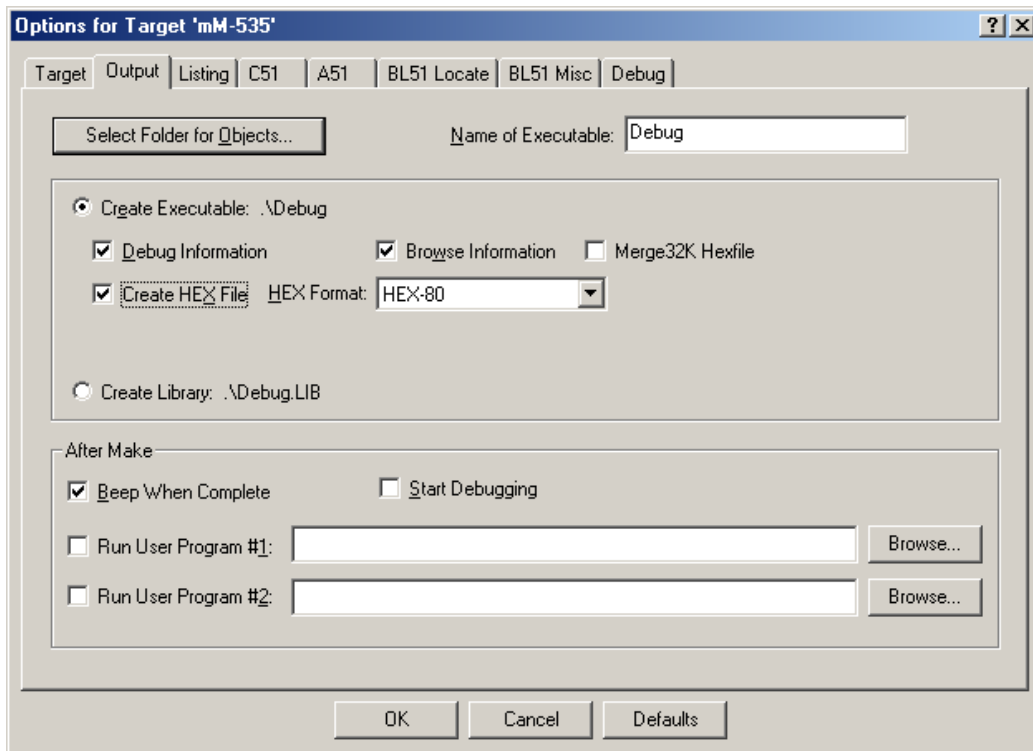

- Go to the **C51** tabsheet and erase all defines from the *Define:* input field and adjust the optimization to your needs.

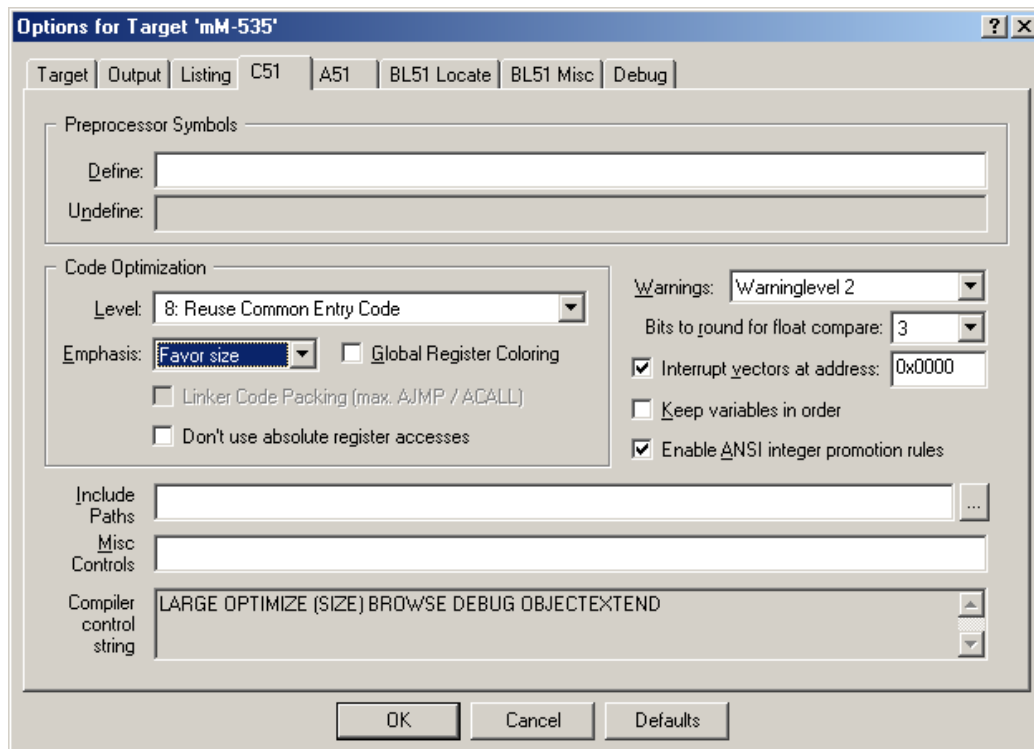

- Click on the *OK* button to save the settings.
- Click on the *Rebuild all target files* icon  to compile and link your project.
- Download the created **Debug.hex** file (located in **C:\PHYBasic\mM-535\Demos\Keil\Debug**) to the Flash memory. For general download procedure information refer to sections 2.2 through 2.4.1.
- Press the Reset button S1 on the Development Board to start the program.
- The application is now waiting for receipt of a known character over the serial interface. Start the HyperTerminal program and push the <Space> bar as described in section 2.4.2. This starts the automatic baud rate detection. Now you can watch your final debug example execute.

5 Advanced User Information

This section provides advanced information for successful operation of the miniMODUL-535 in conjunction with the Keil tool chain.

5.1 FlashTools98

Flash is a highly functional means of storing nonvolatile-data. One of its advantages among many others is the possibility of on-board programming. Programming tools for the Flash device are always included with the miniMODUL-535 in the form of a pre-programmed Flash with a resident microcontroller firmware and a counterpart software serving as the user interface on a host-PC. Once the firmware communicates with the PC-based software, FlashTools98 allows the download of user code from the host-PC into the Flash. Additionally, the re-programmable Flash device on the miniMODUL-535 allows you to easily update your own code and the target application in which the miniMODUL-535 has been implemented.

Currently the miniMODUL-535 can be populated with two different sized Flash devices: a 29F010 with 128 kByte or a 29F040 with 512 kByte. To support the entire memory area of these devices the address decoder of the miniMODUL-535 is equipped with an integrated banking mechanism that allows code-bank switching in code-banks of 64 kByte each.

Please note that the FlashTools98 kernel always occupies the first 64 kByte bank (bank 0, FA[18..15] = 0000b) of the Flash memory. This bank is pre-programmed upon delivery of the miniMODUL-535. The remaining banks are available to house your application. This makes one user application bank available if the miniMODUL-535 is mounted with a 29F010 and seven user application banks if the miniMODUL-535 is mounted with a 29F040 Flash memory device. Multiple user application banks can easily be managed by using the Code Banking mechanism of the Keil tool chain.

The following description is valid only for the FlashTools98 included with the miniMODUL-535 and is not intended as a guideline for using any other program.

FlashTools98 incorporates a safety mechanism that ensures that the system bank (bank 0), in which the firmware is resident, can not be overwritten during programming of the available user banks of the Flash device.

Resetting the miniMODUL-535 also activates the system bank (bank 0) of the Flash device, which automatically starts the FlashTools98 firmware. Then the firmware either enters the Flash programming mode or starts your user application.

To distinguish between download and execution modes, the firmware checks for the presence of a pull-up resistor (usually 4.7 kOhm) connected to pin D0 (Data 0) of the miniMODUL-535 immediately after reset. This resistor is located on the Development Board and can be connected to the miniMODUL-535 by pressing the Boot (S2) button. To enter the Flash programming mode you must simultaneously press the Reset (S1) and the Boot (S2) button, release the Reset (S1) button first and then, two or three seconds later, release the Boot (S2) button.

Execution of your user application will always start in the second 64 kByte bank (bank 1, FA[18..15] = 0010b). This is to be noted when preparing a software copy of the contents of the address decoder's internal write-only registers.

The extended features of the address decoder on the miniMODUL-535 allows flexibility when configuring the memory model according to your needs and addressing additional Flash banks.

Do not use Flash bank 0 in your application program in order to preserve the FlashTools98 microcontroller firmware and the associated Flash re-programming capability.

5.2 STARTUP.A51

The code within the assembly file *Startup.a51* initializes the target hardware for your C project. This includes setting of the system stack, initialization of variables and clearing of memory areas.

The *Startup.a51* routines always start at code memory address 0x0000. This is where the reset vector with the jump instruction to the actual *Startup.a51* initialization functions is located. Following a hardware or software reset, the microcontroller starts execution at address 0x0000 and then jumps to the start-up routines location configured by the reset vector. After performing the initialization steps, your individual *main()* function is called by the startup code.

To configure the start-up code to fit the needs of your application, copy it from the *Lib* folder of the Keil tool chain to your project folder. You can then edit, modify and compile it using the Keil macroassembler.

You must explicitly instruct the linker to take into account your start-up object file. If not, the start-up code in the default runtime libraries will be used. To do this, we recommend adding your modified *Startup.a51* file to your project. Ensure that this file is always included in the Link/Lib process of your project (*see options within the Project window of the Keil tool chain*).

We recommend that you add *Startup.a51* or *Startup.obj* (depending on the kind of file you want to add to the project) within the project tree.

5.3 Linking and Locating

The Linker must combine several relocatable object modules contained in object files and/or libraries to generate a single absolute object.

In addition, the linker must locate several segments of code and data to fixed address locations within the address space in regards to the memory types of the miniMODUL-535. XDATA segments always must be located to Random Access Memory (e.g. RAM), CODE segments should be located to non-volatile memory (e.g. Flash). The 8051 family supports a Harvard memory architecture that distinguishes between non-volatile and randomly accessible memory and has two physically different signals for separate fetching of data and code.

The Keil tool chain distinguishes the following segment types:

- **CODE:** code
- **XDATA:** external data (max. 64 kByte)
- **DATA:** direct addressable on-chip data (max. 128 Byte)
- **IDATA:** indirect addressable on-chip data (max. 256 Byte)
- **BIT:** bit-addressable on-chip data (max. 128-bits)

The segment types DATA, IDATA and BIT always reside in the on-chip RAM of the controller.

The segment types XDATA and CODE will usually reside in external memory devices.

To ensure proper execution of your application, it is required that all XDATA segments are located to the external RAM of the miniMODUL-535 and that all CODE segments are located to the external Flash memory of the miniMODUL-535. Exceptions may occur if you use a 8051 derivative with on-chip portions of XDATA (e.g. internal XRAM) or CODE (e.g. internal ROM).

Since the miniMODUL-535 is equipped with a software configurable address decoder instead of simple programmable logic device, you can configure the memory model to your needs at runtime.

To ensure proper execution of your application, you must take the runtime memory model into consideration when linking and locating. This means that you must instruct the linker where to assume external RAM for locating data segments and Flash for locating code segments.

The standard configuration of the miniMODUL-535 is equipped with 32 kByte of external RAM and 128 kByte of external Flash. During runtime the RAM will be addressable at 0x0000 to 0x7FFF. The Flash user bank (bank 1, FA[18..15] = 0010b) will be addressable at 0x0000 to 0xFFFF. This default runtime memory model requires no additional linker settings because both RAM and Flash start at 0x0000. This is also the default start address of the linker's segment types.

Since you can not define any end address, you should always ensure that the size of the segments fits within the available size of the mounted memory devices. For instance all XDATA segments should end below 0x7FFF if a 32 kByte RAM device is mounted on the miniMODUL-535. We recommend generation of a **.m51* map file for your project and inspection of the memory map information within this file.

Whenever you modify the memory model (e.g. use von Neumann rather than Harvard memory), which leads to different start addresses of CODE or XDATA memory, you must configure this in the linker settings.

When using the full version of the Keil tool chain, the start address of the CODE memory should be at 0x100. This avoids conflicts with the interrupt/reset vector table which is located between 0x0000 and 0x00FF.

Document: miniMODUL-535 QuickStart Instructions
Document number: L-386e_3, December 2002

How would you improve this manual?

Did you find any mistakes in this manual? _____ page

Submitted by:

Customer number: _____

Name: _____

Company: _____

Address: _____

Return to:

PHYTEC Technologie Holding AG
Postfach 100403
D-55135 Mainz, Germany
Fax : +49 (0) 6131 9221-33

Published by

PHYTEC

© PHYTEC Meßtechnik GmbH 2002

ordering No. L-386e_3
Printed in Germany