

phyCORE-P87C591

QuickStart Instructions

**Using PHYTEC FlashTools98 for Windows and the Keil μ Vision2
Software Evaluation Development Tool Chain**

Note: The PHYTEC Spectrum CD includes the electronic version of
the English phyCORE-P8xC591 Hardware Manual

Hinweis: Die PHYTEC Spektrum CD beinhaltet die elektronische
Version des deutschen phyCORE-P8xC591 Hardware Manuals

Edition: July 2002

A product of a PHYTEC Technology Holding company

In this manual are descriptions for copyrighted products that are not explicitly indicated as such. The absence of the trademark (™) and copyright (©) symbols does not imply that a product is not protected. Additionally, registered patents and trademarks are similarly not expressly indicated in this manual.

The information in this document has been carefully checked and is believed to be entirely reliable. However, PHYTEC Meßtechnik GmbH assumes no responsibility for any inaccuracies. PHYTEC Meßtechnik GmbH neither gives any guarantee nor accepts any liability whatsoever for consequential damages resulting from the use of this manual or its associated product. PHYTEC Meßtechnik GmbH reserves the right to alter the information contained herein without prior notification and accepts no responsibility for any damages which might result.

Additionally, PHYTEC Meßtechnik GmbH offers no guarantee nor accepts any liability for damages arising from the improper usage or improper installation of the hardware or software. PHYTEC Meßtechnik GmbH further reserves the right to alter the layout and/or design of the hardware without prior notification and accepts no liability for doing so.

© Copyright 2002 PHYTEC Meßtechnik GmbH, D-55129 Mainz.

Rights - including those of translation, reprint, broadcast, photomechanical or similar reproduction and storage or processing in computer systems, in whole or in part - are reserved. No reproduction may occur without the express written consent from PHYTEC Meßtechnik GmbH.

	EUROPE	NORTH AMERICA
Address:	PHYTEC Technologie Holding AG Robert-Koch-Str. 39 D-55129 Mainz GERMANY	PHYTEC America LLC 203 Parfitt Way SW, Suite G100 Bainbridge Island, WA 98110 USA
Ordering Information:	+49 (800) 0749832 order@phytec.de	1 (800) 278-9913 info@phytec.com
Technical Support:	+49 (6131) 9221-31 support@phytec.de	1 (800) 278-9913 support@phytec.com
Fax:	+49 (6131) 9221-33	1 (206) 780-9135
Web Site:	http://www.phytec.de	http://www.phytec.com

5th Edition: July 2002

1	Introduction to the Rapid Development Kit	1
1.1	Rapid Development Kit Documentation	1
1.2	Overview of this QuickStart Instruction.....	2
1.3	System Requirements	3
1.4	The PHYTEC phyCORE-P87C591	4
1.5	The Keil Software Evaluation Development Tool Chain.....	7
2	Getting Started.....	11
2.1	Installing Rapid Development Kit Software.....	11
2.2	Interfacing the phyCORE-P87C591 to a Host-PC	18
2.3	Starting PHYTEC FlashTools98 for Windows	20
2.4	Downloading Example Code with FlashTools	21
2.4.1	"Blinky"	25
2.4.2	"Hello"	27
2.4.3	CAN Demonstration Program	32
3	Getting More Involved.....	33
3.1	Starting the Keil μ Vision2 Tool Chain.....	33
3.2	Creating a New Project and Adding an Existing Source File.....	35
3.3	Modifying the Source Code.....	40
3.4	Saving the Modifications.....	41
3.5	Setting Tool Chain Options	42
3.6	Building the Project	45
3.7	Downloading the Output File	46
3.8	"Hello2"	47
3.8.1	Creating a New Project.....	47
3.8.2	Modifying the Example Source	48
3.8.3	Setting Tool Chain Options	48
3.8.4	Building the New Project	48
3.8.5	Downloading the Output File	49
3.8.6	Starting the Terminal Emulation Program.....	50

4	Debugging	51
4.1	Preparing the Target Hardware to Communicate with μVision2 Target Monitor.....	52
4.2	Creating a Debug Project and Preparing the Debugger	53
4.2.1	Creating a New Project	53
4.2.2	Setting Options for Target.....	54
4.3	Preparing the Debugger.....	59
4.4	Starting the Debugger.....	61
4.5	Keil μVision2 Debug Features	64
4.6	Using the Keil μVision2 Debug Features.....	66
4.6.1	Serial Window	66
4.6.2	Breakpoints.....	67
4.7	Single Stepping and Watch Window.....	68
4.8	Running, Stopping and Resetting.....	70
4.9	Changing Target Settings for the "Final Version"	71
5	Advanced User Information.....	75
5.1	FlashTools98	75
5.2	STARTUP.A51	77
5.3	Linking and Locating	78

Index of Figures

Figure 1:	Keil Tool Chain Overview	8
Figure 2:	Mounting the phyCORE-P87C591 onto the phyCORE Development Board LD 5V	18
Figure 3:	Important Connectors, Buttons and Suitable Jumper Settings on the phyCORE Development Board LD 5V	19
Figure 4:	Power Connector	19
Figure 5:	Memory Model for Use with the Keil Monitor (64 kByte RAM).....	55

1 Introduction to the Rapid Development Kit

This QuickStart provides:

- general information on the PHYTEC phyCORE-P87C591 Single Board Computer (SBC)
- an overview of Keil's μ Vision2 software evaluation development tool chain, and
- instructions on how to run example programs on the phyCORE-P87C591, mounted on the PHYTEC phyCORE Development Board LD 5V, in conjunction with μ Vision2 IDE

Please refer to the [phyCORE-P8xC591 Hardware Manual](#) for specific information on such board-level features as [jumper configuration](#), [memory mapping](#) and [pin layout](#). Selecting the links on the electronic version of this document links to the applicable section of the phyCORE-P8xC591 Hardware Manual.

1.1 Rapid Development Kit Documentation

This "Rapid Development Kit" (RDK) includes the following electronic documentation on the enclosed "PHYTEC Spectrum CD-ROM":

- the PHYTEC [phyCORE-P8xC591 Hardware Manual](#) and [phyCORE Development Board LD 5V Hardware Manual](#)
- controller [User's Manuals and Data Sheets](#)
- this QuickStart Instruction with general "Rapid Development Kit" description, software installation hints and four example programs enabling quick out-of-the box start-up of the phyCORE-P87C591 in conjunction with the Keil software development tools

1.2 Overview of this QuickStart Instruction

This QuickStart Instruction gives a general “Rapid Development Kit” description, as well as software installation hints and four example programs enabling quick out-of-the box start-up of the phyCORE-P87C591 in conjunction with the Keil software development tools. It is structured as follows:

- 1) The *"Getting Started"* section uses three example programs:
 - *"Hello"* and *"Blinky"* to demonstrate the download of user code to the Flash device using PHYTEC FlashTools98 for Windows.
 - An additional demo program demonstrates the CAN Self Receive Capability of the P87C591 microcontroller on the phyCORE-P87C591 module in conjunction with the phyCORE Development Board LD 5V.
- 2) The *"Getting More Involved"* section provides step-by-step instructions on how to modify both examples, create and build new projects and generate and download output files to the phyCORE-P87C591 using the Keil tool chain and FlashTools98.
- 3) The *"Debugging"* section provides a fourth example program - “Debug” - to demonstrate monitoring of the board and simple debug functions using the μ Vision2 debug environment.

In addition to dedicated data for this Rapid Development Kit, this CD-ROM contains supplemental information on embedded microcontroller design and development.

1.3 System Requirements

Use of this “Rapid Development Kit” requires:

- the phyCORE-P87C591 SBC module
- the phyCORE Development Board LD 5V with the included DB-9 serial cable and AC adapter supplying 5 VDC /min. 500 mA
- the PHYTEC Spectrum CD
- an IBM-compatible host-PC (486 or higher running at least Windows95/98)

For more information and example updates, please refer to the following sources:

PHYTEC

<http://www.phytec.com> - or - <http://www.phytec.de>
support@phytec.com - or - support@phytec.de

The logo for Keil Software, featuring a stylized blue square icon with a white arrow pointing right, followed by the text "KEIL SOFTWARE" in blue.

<http://www.keil.com>
support@keil.com

1.4 The PHYTEC phyCORE-P87C591

The phyCORE-P87C591 represents an affordable, yet highly functional Single Board Computer (SBC) solution in subminiature dimensions (40 x 55 mm). The standard board is populated with a Philips P87C591 controller, featuring a 6-channel on-chip A/D-converter with 10-bit resolution and an integrated CAN controller.

All applicable data/address lines and applicable signals extend from the underlying logic devices to standard-width (2.54 mm /0.10 in.) pin headers lining the circuit board edges. This enables the phyCORE-P87C591 to be plugged like a “big chip” into target hardware.

The standard memory configuration of the phyCORE-P87C591 features 128 kByte external SRAM and 128 kByte external Flash for code storage (64 kByte for FlashTools firmware and 64 kByte for storage of user code). The Flash device allows direct on-board programming. Three Chip Select signals are available for external I/O connectivity.

The module communicates by means of an RS-232 transceiver and operates within a standard industrial range of 0 to +70 degrees C. It requires only a 250 mA power source.

PHYTEC FlashTools98 enables easy on-board download of user programs.

phyCORE-P87C591 Technical Highlights

- SBC in subminiature dimensions (40 x 55 mm) achieved through advanced SMD technology
- populated with an 44-pin packaged (PLCC) Philips 8051-compatible P87C591 controller featuring 2.0B on-chip CAN with extended Philips PeliCAN
- instruction cycle time of 375 ns at 16 MHz clock speed (no internal clock prescaler)
- 128 kByte external SRAM
- 128 (to 512) kByte external Flash supporting on-board downloading of user code from a host-PC in conjunction with PHYTEC FlashTools98 firmware
- RS-232 serial interface
- 2.0B CAN bus interface supporting 11-bit and 29-bit message identifiers
- 6-channel on-chip A/D converter with 10-bit resolution
- three Chip Select signals for connection to external peripherals
- requires only a +5 V/250 mA power source
- operates in a temperature range of 0... 70°C (optional -40... 85°C temperature range available)

The phyCORE Development Board LD 5V, in EURO-card dimensions (160 x 100 mm), is fully equipped with all mechanical and electrical components necessary for the speedy and secure insertion, and subsequent programming, of PHYTEC phyCORE series Single Board Computers with standard width (2.54 mm/ 0.10 in.) pin header connectors. Simple jumper configuration readies the Development Board's connection to any phyCORE module (standard header pins), which plug pins-down into the contact strips mounted on the phyCORE Development Board LD 5V.

phyCORE Development Board LD 5V Technical Highlights

- Reset signal controlled by push button or RS-232 control line CTS0
- Boot signal controlled by push button or RS-232 control line DSR0
- low voltage socket for supply with regulated input voltage 5 VDC
- additional supply voltage 3.3 VDC
- two DB-9 sockets (P1A, P1B) configurable as RS-232 interfaces
- two additional DB-9 plugs (P2A, P2B) configurable as CAN interfaces, connector P2B optionally configurable as RS-485 interface
- simple jumper configuration allowing use of the phyCORE Development Board LD 5V with various PHYTEC phyCORE SBC's
- one control LED D3 for quick testing of user software
- 2 x 160-pin Molex connector (X2) enabling easy connectivity to expansion boards (e.g. PHYTEC GPIO Expansion Board)

1.5 The Keil Software Evaluation Development Tool Chain

The Keil software evaluation development tool chain fully supports the entire 8051 and 8051-derivative microcontroller family, including the Philips P8xC591 family. This includes a C compiler, macro-assembler, linker/locator and the simulator and target monitor within the μ Vision2 IDE.

The Keil tool chain consists of the following executables:

- **C Compiler** c51.exe
- **Assembler** a51.exe
- **Linker** bl51.exe
- **Converter** oh51.exe
- **μ Vision2** Uv2.exe (a Windows-based application)

Once installed, the default destination location for the DOS-based files is the *C:\Keil\C51\Bin* directory while μ Vision2 is in *C:\Keil\Uv2*. Access to these programs from Windows is accomplished within μ Vision2. The entire tool set can be run from μ Vision2 or directly from DOS with batch files. The evaluation version of the Keil tool chain is restricted to a manipulable code size of 2 kByte. In addition the code will automatically be located at 0x4000 in order to prevent unauthorized use of this version for programming of common devices with internal code memory less or equal than 2 kByte. Other than these restrictions, the evaluation tool chain functions exactly as the full version does, enabling full evaluation of the features and functionality of Keil development tools. The full version has no such restrictions, both are fully ANSI compliant.

μVision2 IDE

μVision2 is a Windows-based Graphical User Interface for the C compiler and assembler. All compiler, assembler and linker options are set with simple mouse clicks. μVision2 runs under Windows 95/98/ME/NT and 2000. This Integrated Development Environment (IDE) has been expressly designed with the user in mind and includes a fully functional editor.

All IDE commands and functions are accessible via intuitive pull-down menus with prompted selections. An extensive Help utility is included. External executables can be run from within μVision2, including emulator software.

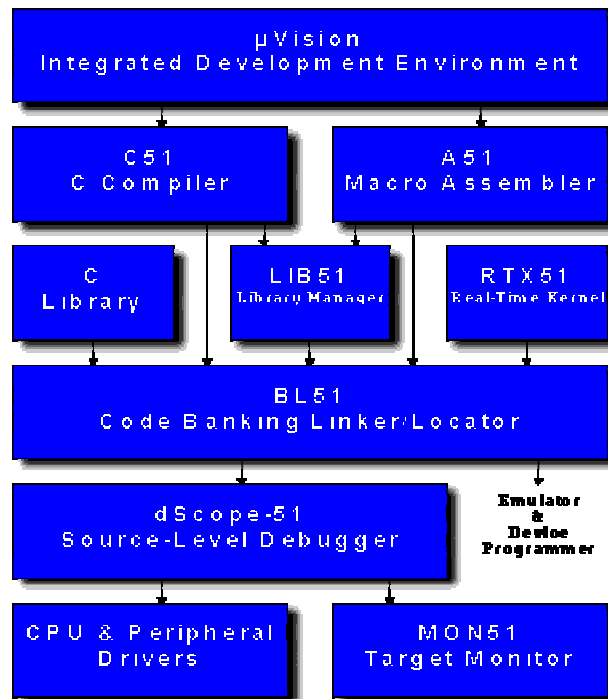

Figure 1: Keil Tool Chain Overview

C51 C Compiler

The C51 ANSI compiler is specifically designed for the 8051 microcontroller family. The compiler can be run either in a DOS box under Windows or directly from μ Vision2.

A51 Macroassembler

The assembler can be run either in a DOS box under Windows or directly from μ Vision2.

BL51 Code Banking Linker/Locator

The BL51 linker/locator is used to join re-locatable object modules and library files together and to locate them to fixed memory locations. It supports Code Banking for easy management of multiple code-banks to allow applications with more than 64 kByte of code. The library and object files created with the C51 compiler or the A51 assembler are provided by Keil. This process results in absolute object modules. The BL51 is DOS-based and can be run within a DOS box under Windows or directly from μ Vision2. A map file (*.m51) can be produced, giving details of the memory structure. The object file may be specified to contain debugging information as required by simulators, debuggers and emulators. The BL51 also supports an overlay mechanism for variables to optimize the use of the size-restricted internal RAM.

OH51 Object-Hex Converter

The Keil OH51 object-to-hex converter transforms an absolute object file produced by the BL51 Banking Linker into a standard Intel *.hex file. This file is suitable as an input to the PHYTEC FlashTools98 or for programming into an EPROM or an emulator. OH51 can be run in a DOS box under Windows or directly from μ Vision2.

Debug Environment

µVision2 contains a software simulator supporting debugging either via software on a host-PC or in target hardware. When operated in conjunction with the Keil monitor resident in target hardware µVision2 enables the following debugging functions:

- run/halt
- set breakpoints
- examine/change memory
- view the stack
- view/set peripheral information
- apply virtual external signals

µVision2 has a performance analysis feature to ensure your code runs efficiently. In addition, µVision2 has a disassembler/assembler that allows the modification of user code without recompiling.

2 Getting Started

What you will learn with this Getting Started example:

- installing Rapid Development Kit software
- starting PHYTEC FlashTools98 for Windows download utility
- interfacing the phyCORE-P87C591, mounted on the phyCORE Development Board LD 5V, to a host-PC
- downloading example user code in Intel hexfile format from a host-PC to the external Flash memory using FlashTools98

2.1 Installing Rapid Development Kit Software

- Insert the PHYTEC Spectrum CD into the CD-ROM drive of your host-PC.

The PHYTEC Spectrum CD should automatically launch a setup program that installs the software required for the Rapid Development Kit as specified by the user. Otherwise the setup program *start.exe* can be manually executed from the root directory of the PHYTEC Spectrum CD.

The following window appears:

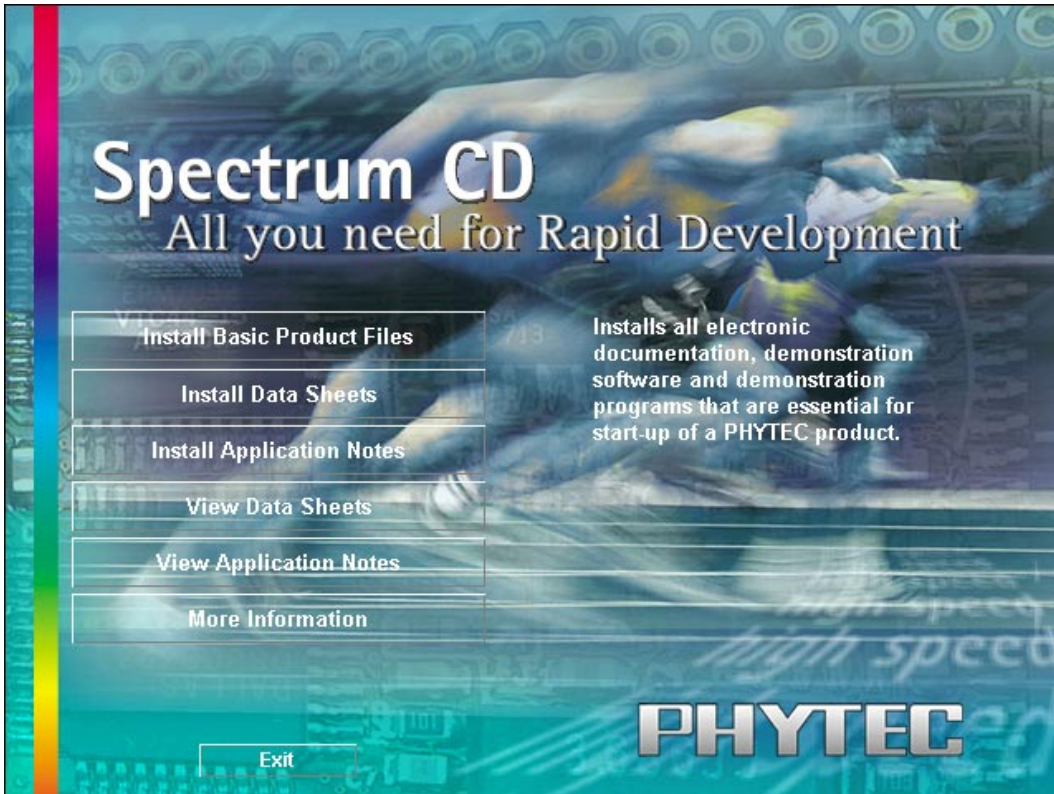

- Choose the *Install Basic Product Files* button.
- After accepting the Welcome window and license agreement, select the destination location for installation of Rapid Development Kit software and documentation.

The default destination location is **C:\PHYBasic**. All path and file statements within this QuickStart Instruction are based on the assumption that you accept the default install paths and drives. If you decide to individually choose different paths and/or drives you must consider this for all further file and path statements.

We recommend that you accept the default destination location.

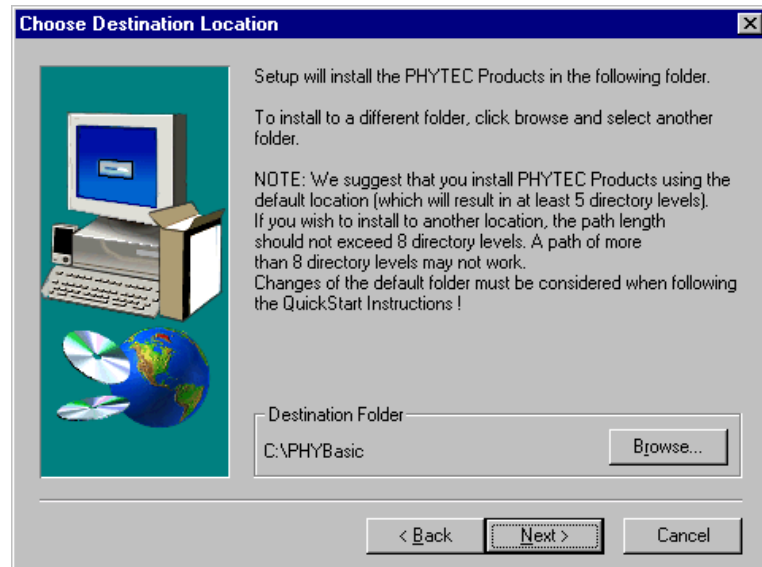

- In the next window, select your Rapid Development Kit of choice from the list of available products. By using the *Change* button, advanced users can select in detail which options should be installed for a specific product.

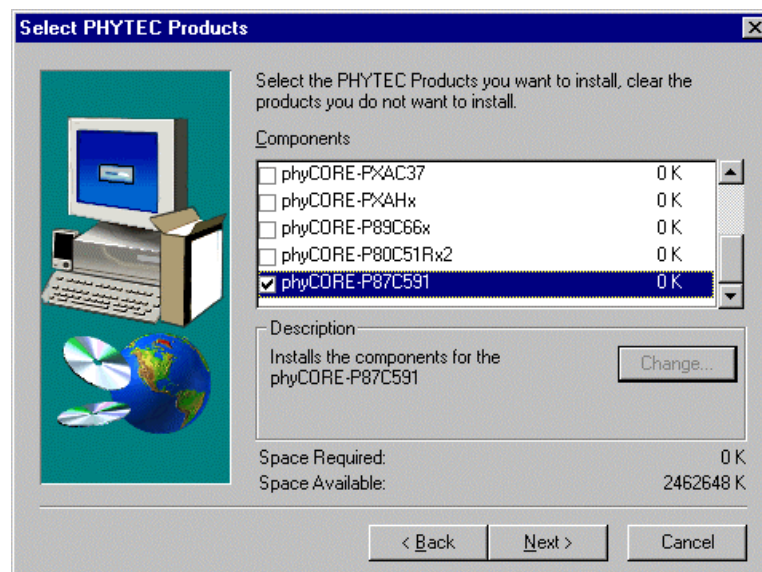

All Kit-specific content will be installed to a Kit-specific subfolder of the Rapid Development Kit root folder that you have specified at the beginning of the installation process.

All software and tools for this phyCORE-P87C591 RDK will be installed to the **|PHYBasic** folder on your hard drive.

- In the next dialog you must choose whether to copy the selected documentation as ***.pdf** files to your hard drive or to install a link to the file on the Spectrum CD.

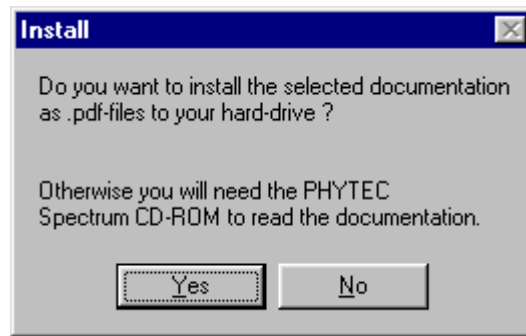

If you decide **not** to copy the documentation to your hard drive, you will need the PHYTEC Spectrum CD-ROM each time you want to access these documents. The installed links will refer to your CD-ROM drive in this case.

If you decide to copy the electronic documentation to your hard drive, the documentation for this phyCORE-P87C591 RDK will also be installed to the kit-specific subfolder. The manuals of the phyCORE Development Board LD 5V are copied to their own specific subfolder (e.g. **|PHYBasic|DevBLD5V**) because each Development Board is suitable for multiple SBC's and is not dedicated to a specific RDK.

Setup will now add program icons to the program folder, named **PHYTEC**.

- Click on *Finish* to complete the installation of PHYTEC products.

- In the next window, you choose the Keil EK51 software development tool chain¹.

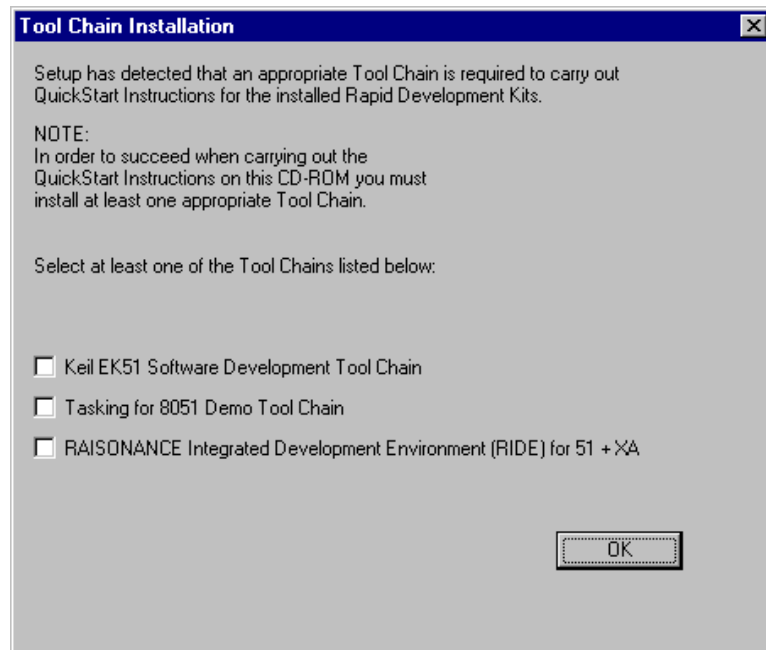

The applicable Keil tool chain must be installed to ensure successful completion of this QuickStart Instruction. Failure to install the proper software could lead to possible version conflicts, resulting in functional problems.

We recommend that you install μ Vision2 from the Spectrum CD-ROM even if other versions of μ Vision2 are already installed on your system. These QuickStart Instructions and the demo software included on the CD-ROM have been specifically tailored for use with one another.

- After accepting the Welcome window and license agreement, select the destination location for installation of the Keil evaluation development tool chain. The default location is **C:\Keil**.

¹: If installing a different Software Development tool chain, please refer to the applicable version of the QuickStart manual.

The Keil evaluation development tool chain will be installed to your hard drive. Additional software, such as Adobe Acrobat Reader, will also be offered for installation.

In the following windows you can decide to install FlashTools98 software and the Acrobat Reader.



The applicable FlashTools software must be installed to ensure successful completion of this QuickStart Instruction. Failure to install the proper software could lead to possible version conflicts, resulting in functional problems.

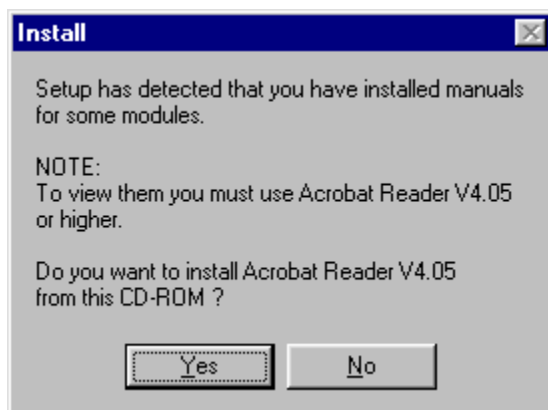

- Decide if you want to begin the QuickStart Instruction immediately by selecting the appropriate checkbox and click on *Finish* to complete the installation.

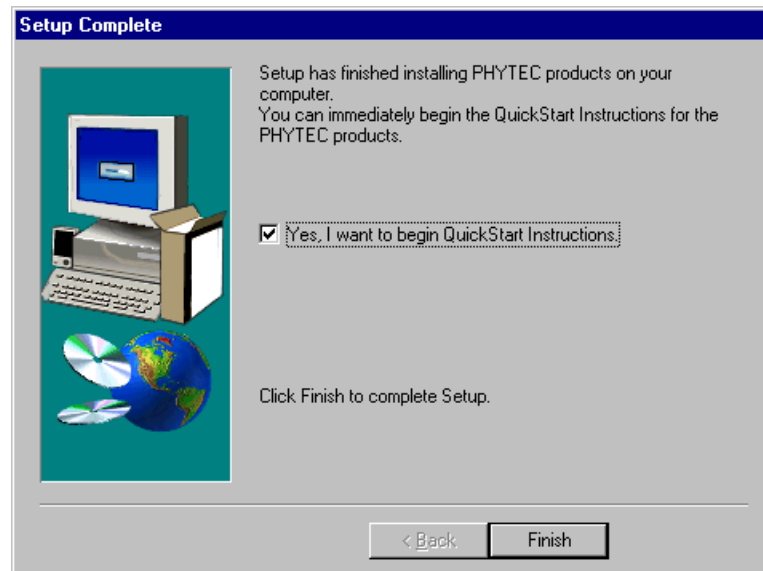

2.2 Interfacing the phyCORE-P87C591 to a Host-PC

Connecting the phyCORE-P87C591, mounted on the phyCORE Development Board LD 5V, to your computer is simple:

- As shown in the figure below, if the phyCORE module is not already preinstalled, mount it pins-down onto the Development Board's receptacle footprint (X6).
- Ensure that pin 1 of module (denoted by the hash stencil mark on the PCB) matches pin 1 of the receptacle on the phyCORE Development Board LD 5V.
- Ensure that there is a solid connection between the module pins and the phyCORE Development Board LD 5V receptacle.

Caution:

Take precautions not to bend the pins when the phyCORE module is removed from and inserted onto the phyCORE Development Board LD 5V.

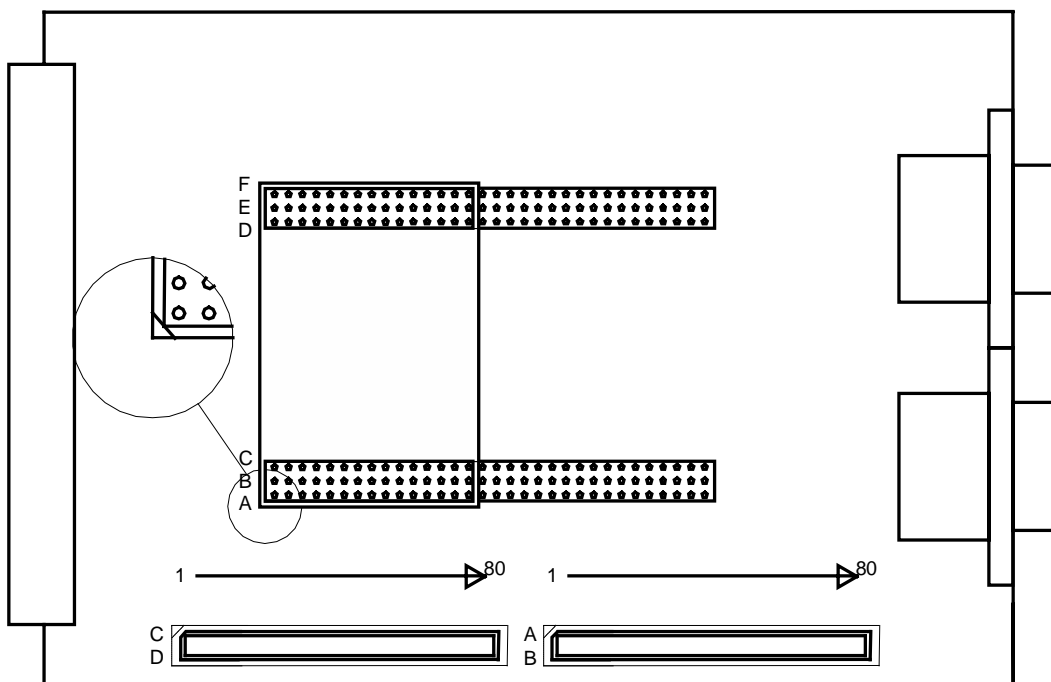

Figure 2: Mounting the phyCORE-P87C591 onto the phyCORE Development Board LD 5V

- Configure the jumpers on the phyCORE Development Board LD 5V as indicated below. This correctly routes the RS-232 signals to the DB-9 connector (P1A = bottom) and connects the Development Board's peripheral devices to the phyCORE module.

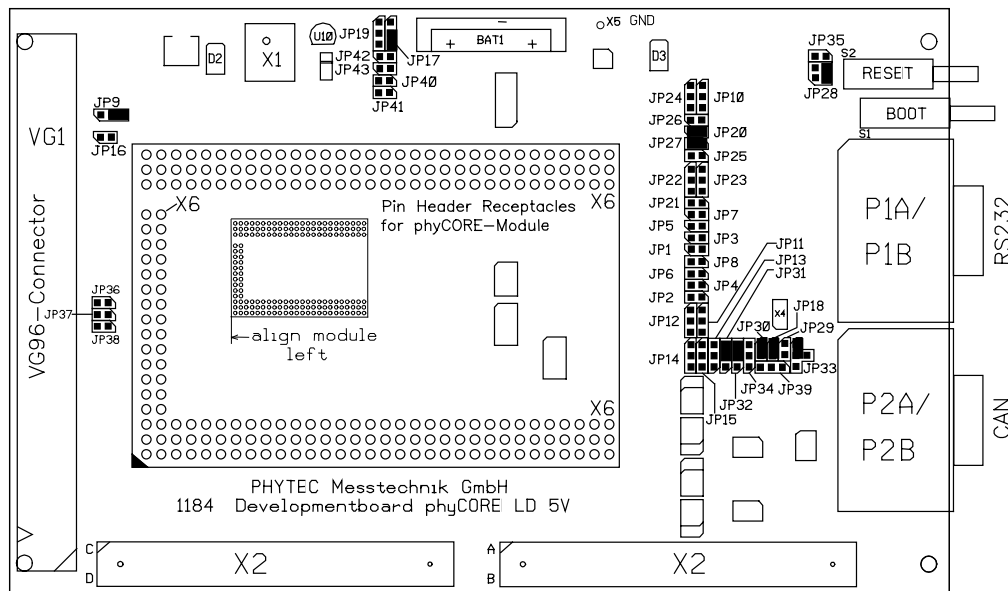

Figure 3: Important Connectors, Buttons and Suitable Jumper Settings on the phyCORE Development Board LD 5V

- Connect the RS-232 interface of your computer to the DB-9 RS-232 interface on the phyCORE Development Board LD 5V (P1A = bottom) using the included serial cable.
- Using the included power adapter, connect the power socket on the board (X1) to a power supply (refer to Figure 4 for the correct polarity).

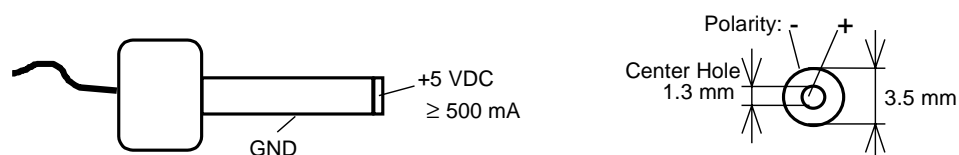

Figure 4: Power Connector

- Simultaneously press the Reset (S2) and Boot (S1) buttons on the phyCORE Development Board LD 5V, first releasing the Reset and then, two or three seconds later, release the Boot button.

This sequence of pressing and releasing the Reset (S2) and Boot (S1) button renders the phyCORE-P87C591 into the Flash programming mode (FPM). Use of FlashTools98 always requires the phyCORE-P87C591 to be in FPM. See *section 2.4, “Downloading Example Code with FlashTools”* for more details.

The phyCORE module should now be properly connected via the phyCORE Development Board LD 5V to a host-PC and power supply. After executing a Reset and rendering the board in Flash programming mode, you are now ready to program the phyCORE-P87C591. This phyCORE module/phyCORE Development Board LD 5V combination is also referred to as “target hardware”.

2.3 Starting PHYTEC FlashTools98 for Windows

FlashTools98 should have been installed during the initial setup procedure as described in *section 2.1*. If not, you can manually install it using the *setup.exe* file located in the folder `\Software\FlashTools98\`.

FlashTools98 for Windows is a utility program that allows download of user code in Intel **.hex* file format from a host-PC to a PHYTEC SBC via an RS-232 connection.

FlashTools98 consists of firmware resident in the external Flash and corresponding software installed on the host-PC. Proper connection of a PHYTEC SBC to a host-PC enables the software portion of FlashTools98 to recognize and communicate to the firmware portion.

- You can start FlashTools98 by selecting it from the *Programs* menu using the Windows *Start* button.

It is recommended that you drag the FlashTools98 icon onto the desktop of your PC. This enables easy start of FlashTools98 by double-clicking on the icon.

2.4 Downloading Example Code with FlashTools

- Start FlashTools98 for Windows by double-clicking on the FlashTools98 icon or by selecting *FlashTools98* from within the *Programs/Phytec* program group.
- The Communication Setup tab of the FlashTools98 tabsheet window will now appear. Here you can specify connection properties to the phyCORE-P87C591.

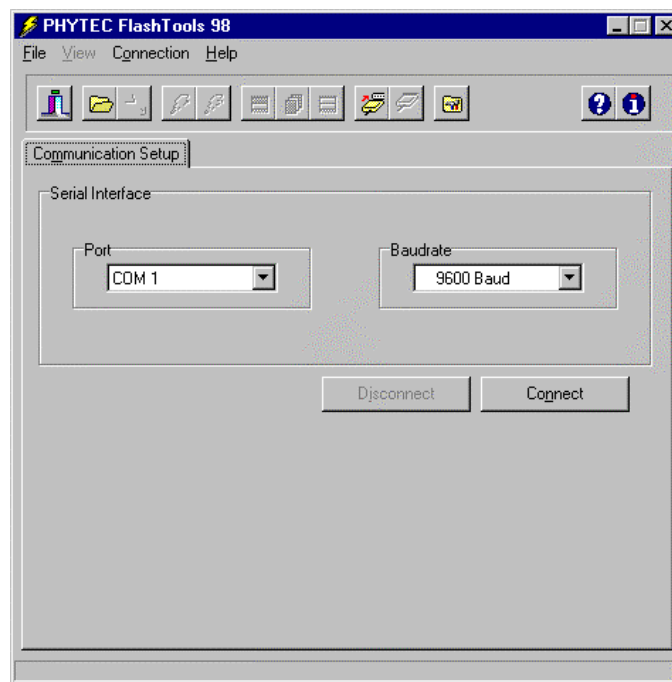

- Choose the correct serial port for your host-PC and a 9,600 baud rate.

Note:

Always ensure that the phyCORE-P87C591 is in Flash programming mode before pressing the *Connect* button.

- Click the *Connect* button to establish connection to the target hardware.

The microcontroller firmware tries to automatically adjust to the baud rate selected within the baud rate tab. However, it may occur that the selected baud rate can not be attained. This results in a connection error. In this case, try other baud rates to establish a connection. Before attempting each connection, be sure to reset the target hardware and render it into Flash programming mode (FPM) as described in *section 2.2*.

Returning to the FlashTool98 tabsheet window, you will see tabs for the following:

*Bank Utilities*² enable erasure and status check of whole banks of memory specified by the user:

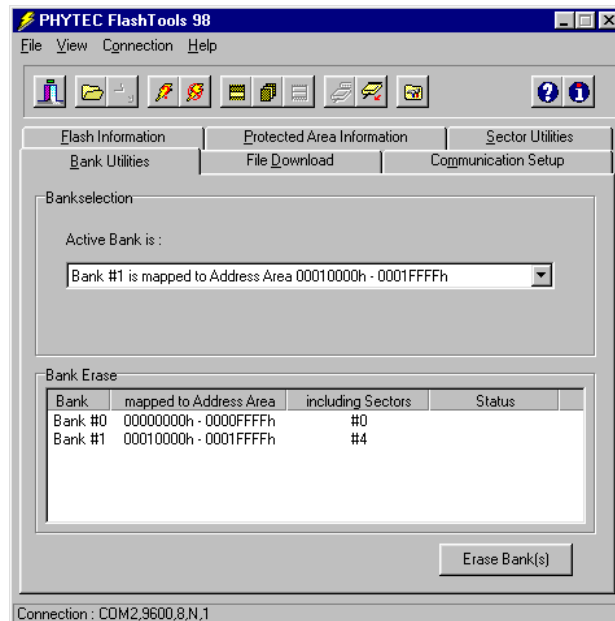

² : The number of banks shown on the *Bank Utilities* tabsheet varies depending on the size and type of the Flash mounted on the phyCORE-P87C591.

*Flash Information*³ shows Flash type, sector and address ranges in Flash memory:

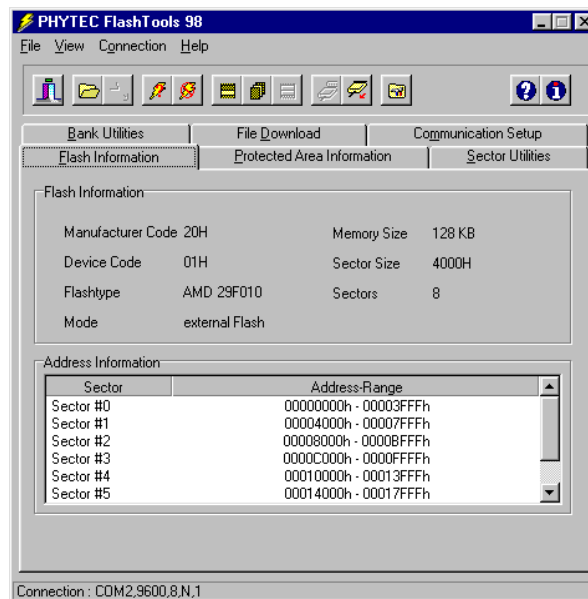

Communication Setup allows selection of the serial port and speed before the communication is initialized, or to disconnect the ongoing communication:

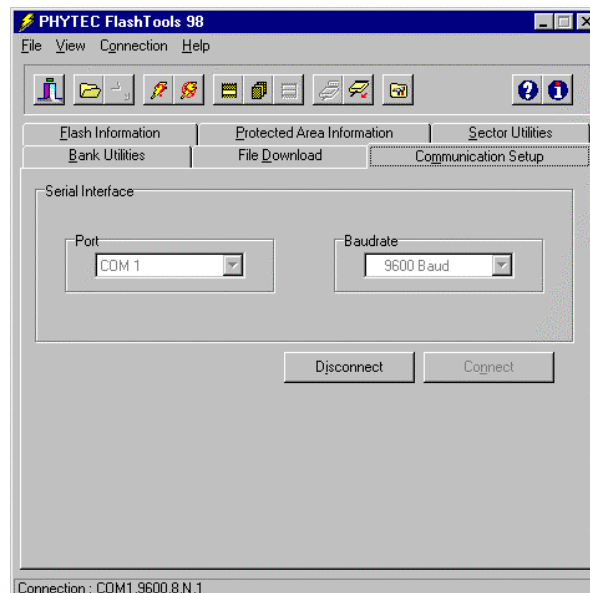

³: The appearance of the *Flash Information* tabsheet varies depending on the size and type of the Flash mounted on the phyCORE-P87C591.

File Download downloads specified hexfiles to the target hardware:

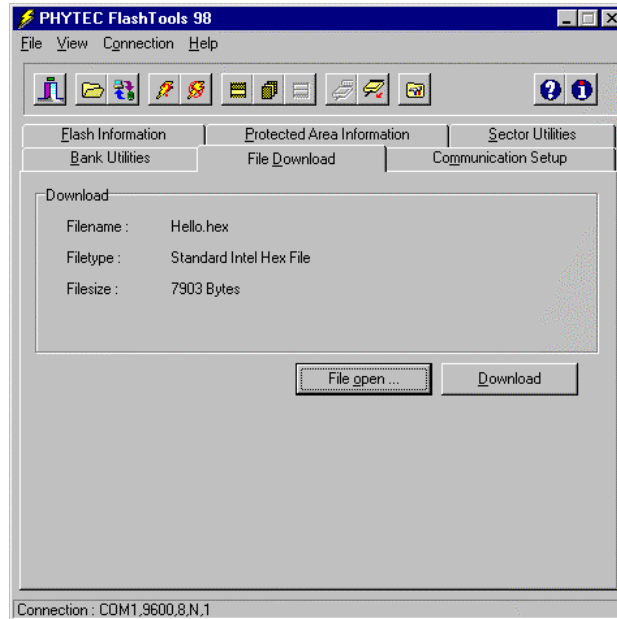

Protected Areas Information shows protected areas of Flash memory:

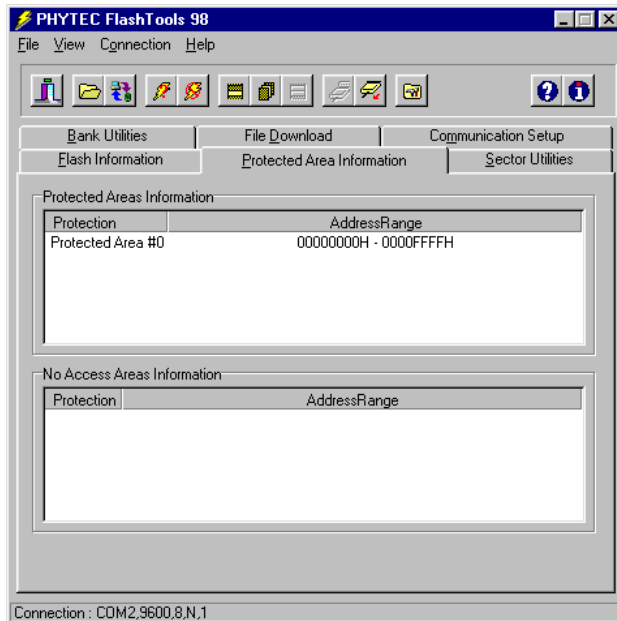

*Sector Utilities*⁴ enable erasure and status check of individual sectors of Flash memory specified by the user:

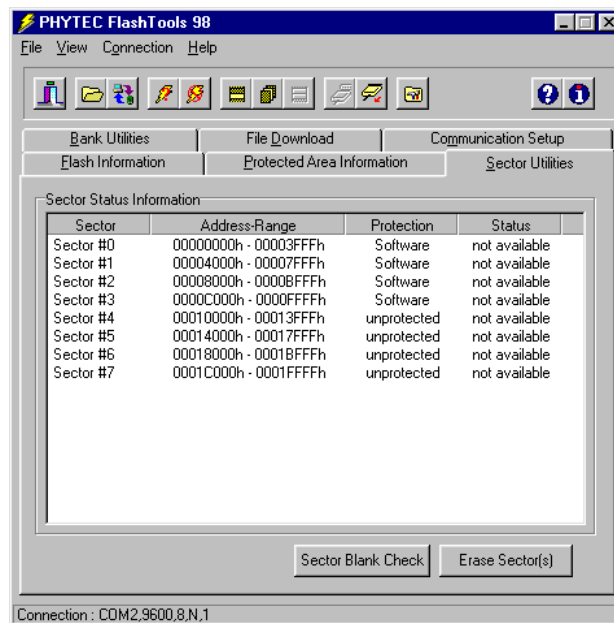

2.4.1 "Blinky"

The “Blinky” example downloads a program to the Flash that, when executed, manipulates the LED D3 on the phyCORE Development Board LD 5V that is located above the jumper field (refer to Figure 3).

- Returning to the FlashTools98 tabsheet, choose the *Bank Utilities* tab, highlight *Bank #1* within the *Bank Erase* section, and click on the *Erase Bank(s)* button to erase this memory bank.
- Wait until the status check in the lower left corner of the FlashTools98 tabsheet finishes, returning the connection properties description to the lower left corner of the window.
- Next choose the *File Download* tab and click on the *File Open* button.

The hexfile has already been installed to your hard drive during the installation procedure.

⁴: The appearance of the *Sector Utilities* tabsheet varies depending on the size and type of the Flash mounted on the phyCORE-P87C591.

- Browse to the correct drive and path for the phyCORE-P87C591 Demo folder (default location **C:\PHYBasic\pC-P87C591\Demos\Keil\Blinky\Blinky.hex**) and click *Open*.
- Click on the *Download* button. You can watch the status of the download of the **Blinky.hex** into external Flash memory in the Download window.

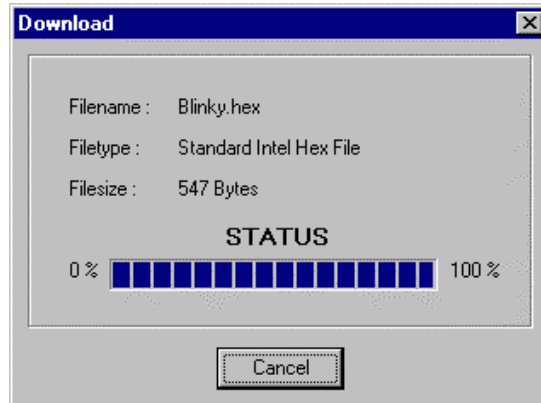

If the selected Flash bank into which you wish to download code is not empty (i.e. erased), a warning dialog box will appear, indicating “Location not empty! Please erase location and try again”. In this event, select the *Bank Utilities* tab from the FlashTools98 tabsheet, highlight *Bank #1* and erase the bank. Then repeat the download procedure.

- At the end of the download, a sector-by-sector status check of the Flash memory can be viewed in the lower left corner of the FlashTools98 tabsheet window. Wait until the status check finishes before returning to work with the board. Once the status check is complete, the downloaded code can be executed.
- Returning to the *Communication* tab, click on the *Disconnect* button and exit FlashTools98.
- Press the Reset button (S2) on the phyCORE Development Board LD 5V to reset the target hardware and to start execution of the downloaded software.
- Successful execution of the program will flash the LED D3 with equal on and off durations.

2.4.2 "Hello"

The “Hello” example downloads a program to the Flash that, when executed, performs an automatic baud rate detection and sends a character string from the target hardware back to the host-PC. The character string can be viewed with a terminal emulation program. This example program provides a review of the FlashTools98 download procedure. For detailed commentary on each step, described below in concise form, *refer back to sections 2.2 through 2.4.1.*

- Ensure that the target hardware is properly connected to the host-PC and a power supply.
- Reset the target hardware and force it into Flash programming mode by simultaneously pressing the Reset (S2) and Boot (S1) buttons on the phyCORE Development Board LD 5V and then releasing first the Reset and, two or three seconds later, the Boot button.
- Start FlashTools98.
- At the *Communication Setup* tab of the FlashTools98 tabsheet, specify the proper serial port and transmission speed (9,600 baud) for communication between host-PC and target hardware and click the *Connect* button to establish connection to the target hardware.
- Returning to the FlashTools98 tabsheet, choose the *Bank Utilities* tab, highlight *Bank #1* within the *Bank Erase* section, and click on the *Erase Bank(s)* button to erase this memory bank.
- Wait until the status check in the lower left corner of the FlashTools98 tabsheet finishes, returning the connection properties description to the lower left corner of the window.
- Next choose the *File Download* tab and click on the *File Open* button.

The demo hexfile has already been installed to your hard drive during the installation procedure.

- Browse to the correct drive and path for the phyCORE-P87C591 Demo folder (default location **C:\PHYBasic\pC-P87C591\Demos\Keil\Hello\Hello.hex**) and click *Open*.
- Click on the *Download* button. You can watch the status of the download of the **Hello.hex** into external Flash memory in the Download window.

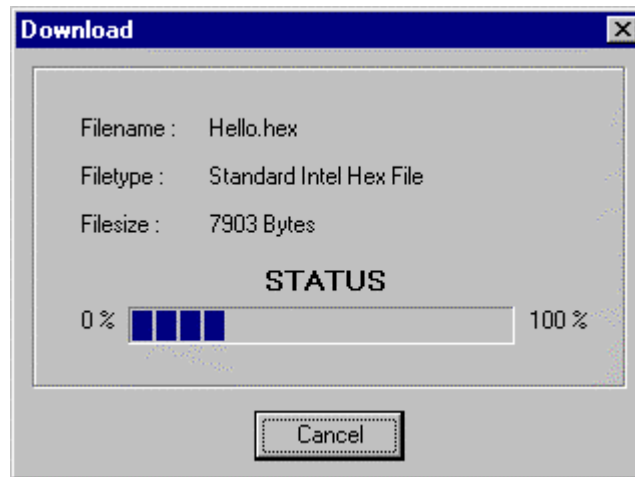

If the selected Flash bank into which you wish to download code is not empty (i.e. erased), a warning dialog box will appear, indicating “Location not empty! Please erase location and try again”. In this event, select the *Bank Utilities* tab from the FlashTools98 tabsheet, highlight *Bank #1* and erase the bank. Then repeat the download procedure.

- At the end of the download, a sector-by-sector status check of the Flash memory can be viewed in the lower left corner of the FlashTools98 tabsheet window. Wait until the status check finishes before returning to work with the board. Once the status check is complete, the downloaded code can be executed.
- Returning to the *Communication* tab, click on the *Disconnect* button and exit FlashTools98.

Monitoring the execution of the Hello demo requires use of a terminal program, such as the HyperTerminal program included within Windows.

- Start the HyperTerminal program within the *Programs/Accessories* bar.
- The HyperTerminal main window will now appear⁵:
- Double-click on the HyperTerminal icon “*Hypertrm*” to create a new HyperTerminal session.



- The Connection Description window will now appear. Enter “COM Direct” in the *Name* text field.

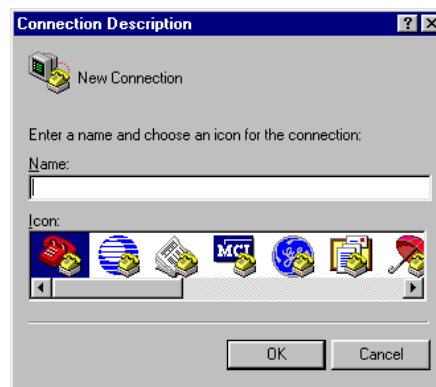

- Next click on *OK*. This creates a new HyperTerminal session named “COM Direct” and advances you to the next HyperTerminal window.

⁵: The HyperTerminal window has a different appearance for different versions of Windows.

- The *COM Direct Properties* window will now appear. Specify *Direct to COM1/COM2* under the *Connect Using* pull-down menu (be sure to indicate the correct COM setting for your system).

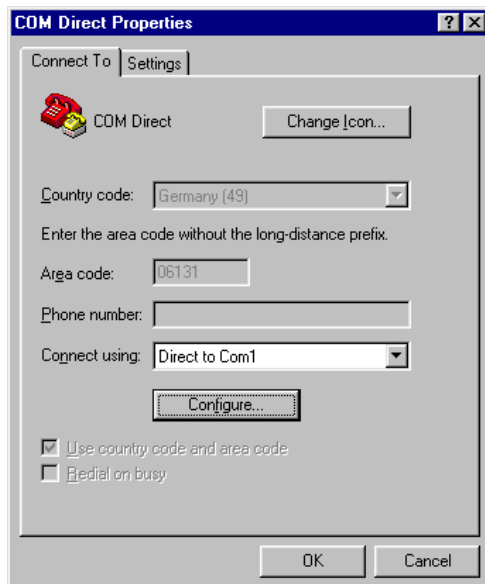

- Click the *Configure* button in the *COM Direct Properties* window to advance to the next window (*COM1/COM2 Properties*).

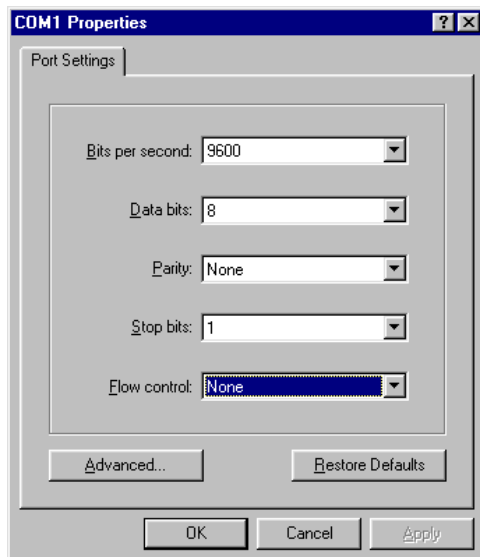

- Then set the following COM parameters: Bits per second = 9600; Data bits = 8; Parity = None; Stop Bits = 1; Flow Control = None.

- Selecting *OK* advances you to the *COM Direct–HyperTerminal* monitoring window. Notice the connection status report in the lower left corner of the window.

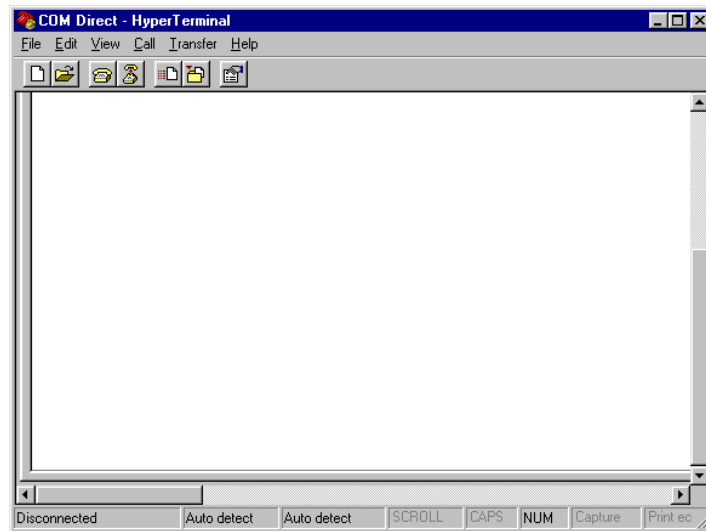

- Resetting the phyCORE Development Board LD 5V (at S2) will execute the *Hello.hex* file loaded into the Flash.
- Now push the <Space> bar on your keyboard once to start the automatic baud rate detection on phyCORE-P87C591 module.
- Successful execution will send the character string "Hello World" from the target hardware to the HyperTerminal window.

Pressing any other key than the <Space> bar leads to an improper baud rate since the automatic baud rate detection is based on the timing measurement during the transmission of a well known character – the <Space> character. As a result you may get incoherent characters in the HyperTerminal window.

- Click the disconnect icon  in HyperTerminal toolbar and exit HyperTerminal.
- If no output appears in the HyperTerminal window check the power supply, the COM parameters and the RS-232 connection.

You have now successfully downloaded and executed two pre-existing example programs in Intel **.hex* file format.

2.4.3 CAN Demonstration Program

This program demonstrates the Controller Area Networking (CAN) Self Reception Request function of the P87C591 microcontroller on the phyCORE-P87C591 module, used in conjunction with the phyCORE Development Board LD 5V. This CAN Self Reception capability allows messages passed on the CAN bus to be received and processed by the originating node. Pressing of the Boot button S1 on the Development Board initiates the transmission of a message over the CAN bus. The CAN identifier used for this example is 0x100.

The CAN message consists of only one data byte. The data byte 0x01 indicates that S1 is pressed, while the data byte 0x00 indicates that S1 is released. Using the Self Reception Request function of the P8xC591 controller, the message will be transmitted to the internal CAN registers. It will then be returned to, and received by, the on-chip CAN controller. Depending on the received data byte, either LED D3 will illuminate (data byte 0x01) or not (data byte 0x00).

Push Button	Data Byte Received	Lit LED
S1 pressed	0x01	D3 on
S1 released	0x00	D3 off

To download this demo program follow the steps described above using FlashTools98. The *Can.hex* demo file has already been installed to your hard-drive during the installation procedure. Its default location is:

C:\PHYBasic\pC-P87C591\Demos\Keil\CAN\Can.hex

Press the Reset button (S2) on the phyCORE Development Board LD 5V to reset the target hardware and to start execution of this demo program. Pressing of Boot button S1 will light LED D3.

3 Getting More Involved

What you will learn with this example:

- how to start the μ Vision2 tool chain
- how to configure the μ Vision2 IDE (Integrated Development Environment)
- how to modify the source code from our examples, create a new project and build and download an output **.hex* file to the target hardware

3.1 Starting the Keil μ Vision2 Tool Chain

The Keil μ Vision2 evaluation software development tool chain should have been installed during the install procedure, as described in *section 2.1*.

You can also manually install μ Vision2 by executing *install.bat* from within the `\Software\Keil\Ek8051` directory of your PHYTEC Spectrum CD.

Note:

It is necessary to use the Keil tool chain provided on the accompanying Spectrum CD in order to complete these QuickStart Instructions successfully. Use of a different version could lead to possible version conflicts, resulting in functional problems.

- Start the tool chain by selecting *Keil μ Vision2* from within the *Programs* group.

After you start μ Vision2, the window shown below appears. From this window you can create projects, edit files, configure tools, assemble, link and start the debugger. Other 3rd party tools such as emulators can also be started from here.

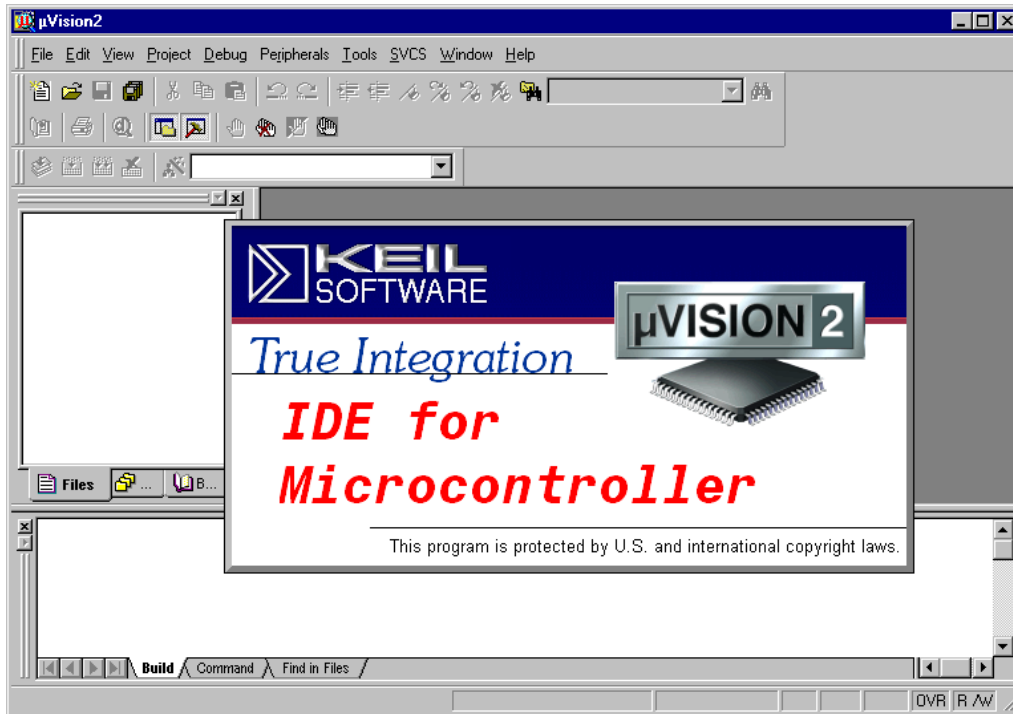

3.2 Creating a New Project and Adding an Existing Source File

μ Vision2 automatically loads the most recently opened project. If you find an existing project when starting μ Vision2, close it by selecting the *Project* menu and *Close* the project.

- To create a new project file select from the μ Vision2 menu *Project/New Project....* This opens a standard Windows dialog box that asks you for the new project file name.
- Change to the project directory created by the installation procedure (default location *C:\PHYBasic\pC-P87C591\Demos\Keil\Blinky2*).

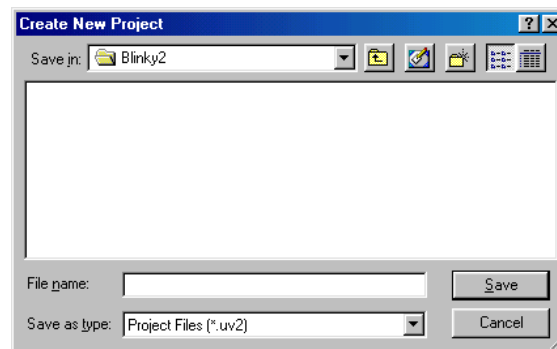

- In the text field '*File name*', enter the file name of the project you are creating. For this example, enter the name *Blinky2* and click on *Save*.

- The **Select Device for Target 'Target 1'** window will appear. Double-click on *Philips* in the CPU vendor data base list. The phyCORE-P87C591 is equipped with a *Philips 87C591*. Choose this controller type from the list as shown below. This selection sets necessary tool options for the *87C591* device, as well as pre-configures additional settings for the device.

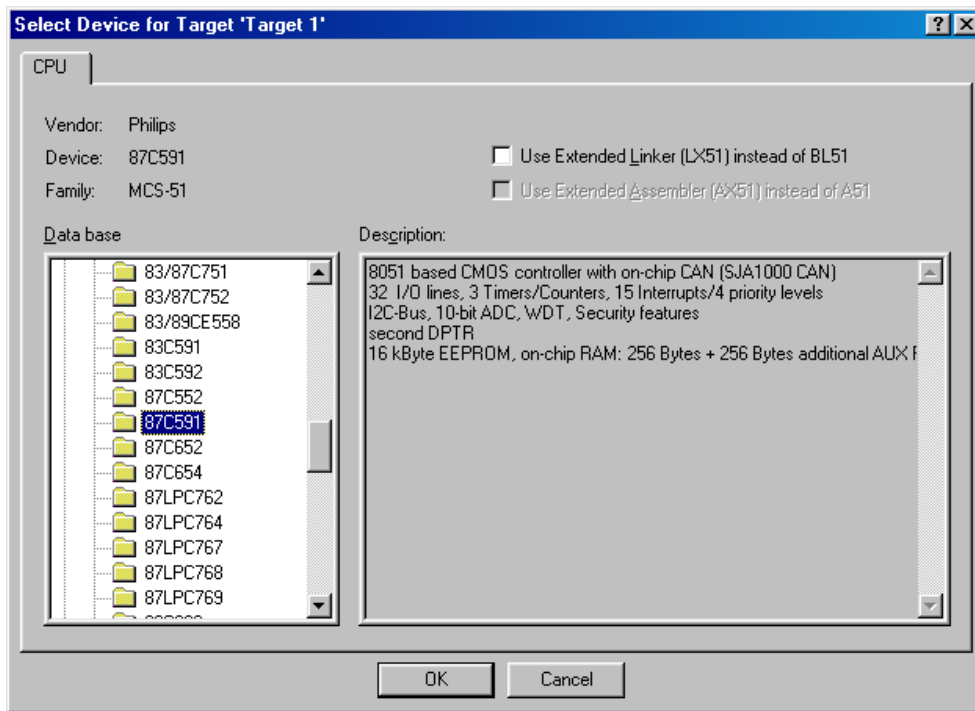

- Click on **OK**.
- Now click on *Target1* within the **Project Window - Files** tab. *Target1* is now highlighted. Click on *Target1* again to enable the edit mode. Change the default name of the target to *phyCORE-P87C591*.

- Select the file group *Source Group 1* in the **Project Window – Files** tab and click on it to change the name into *User*.
- Right-click in the **Project Window – Files** to open a new window. Choose the option *Targets, Groups, Files...*

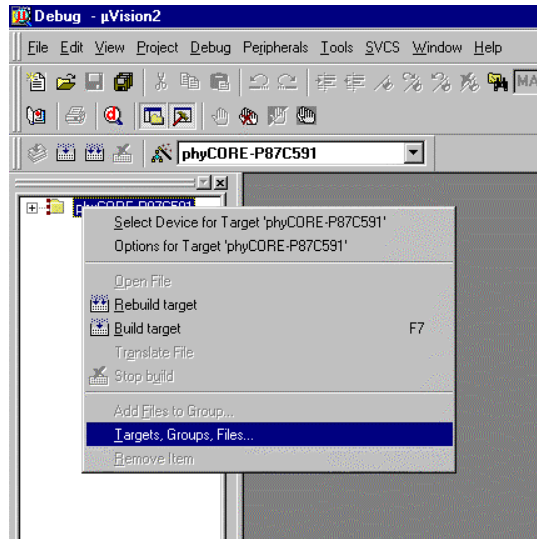

- Select the tab **Groups / Add Files** and type the new group name *System Files* in the **Group to Add:** section.



- Click on *Add* and then on *OK*.

- Your project file structure should now look like this:



- In order to add *Blinky2.c* to our project right-click on the *User* group to open a menu. Select the option *Add Files to Group 'User'* to open the standard files dialog.

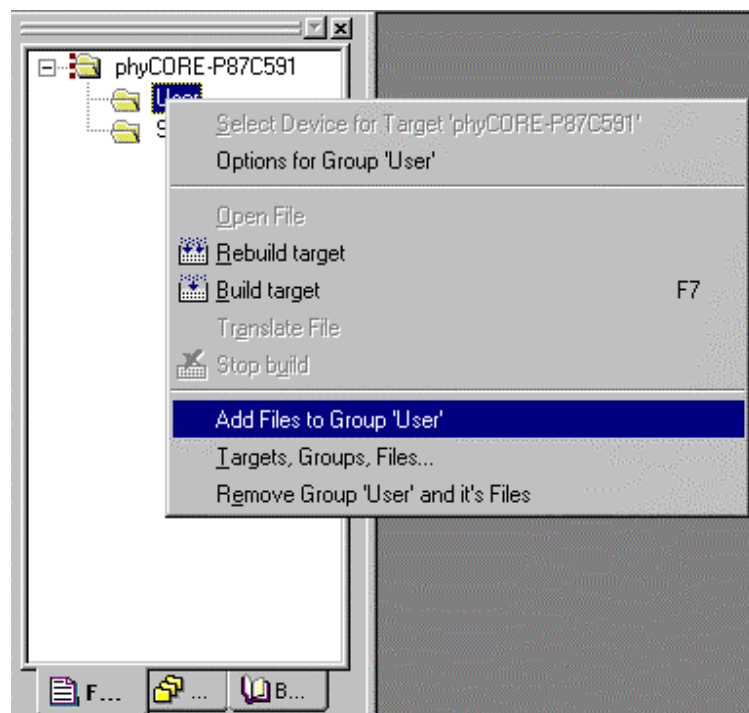

- Select the file *Blinky2.c*.

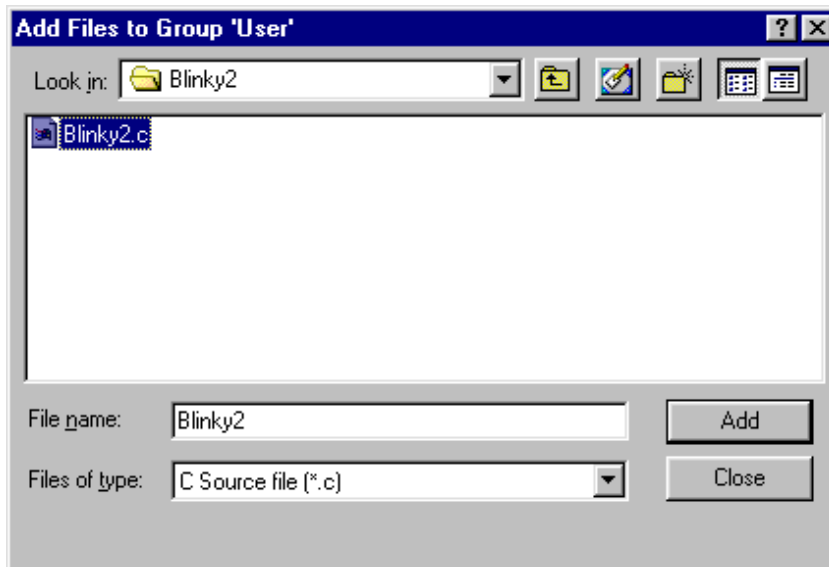

- Click on the *Add* button to add the *Blinky2.c* file to your current project window.
- Close the window.
- Now right-click on group *System Files* and add the file *Startup.a51*. You have to change the file type to “*Asm Source file (*.a, *.src)*” in the *File of types* pull-down menu to see this file.
- Your project window should now look like this:

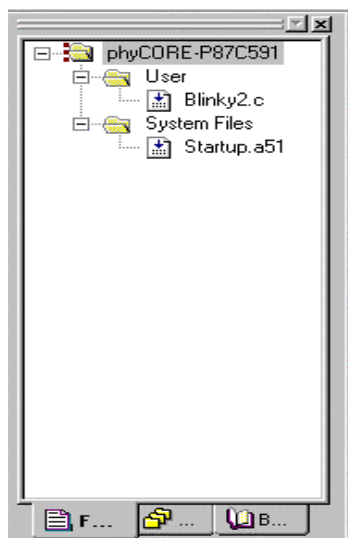

At this point you have created a project called **Blinky2.uv2** and added an existing C source file called **Blinky2.c** and an existing assembler file called **Startup.a51**.

The next step is to modify the C source before building your project. This includes compiling, linking, locating and creating the hexfile.

3.3 Modifying the Source Code

- Double-click on **Blinky2.c** to open it in the source code editor.

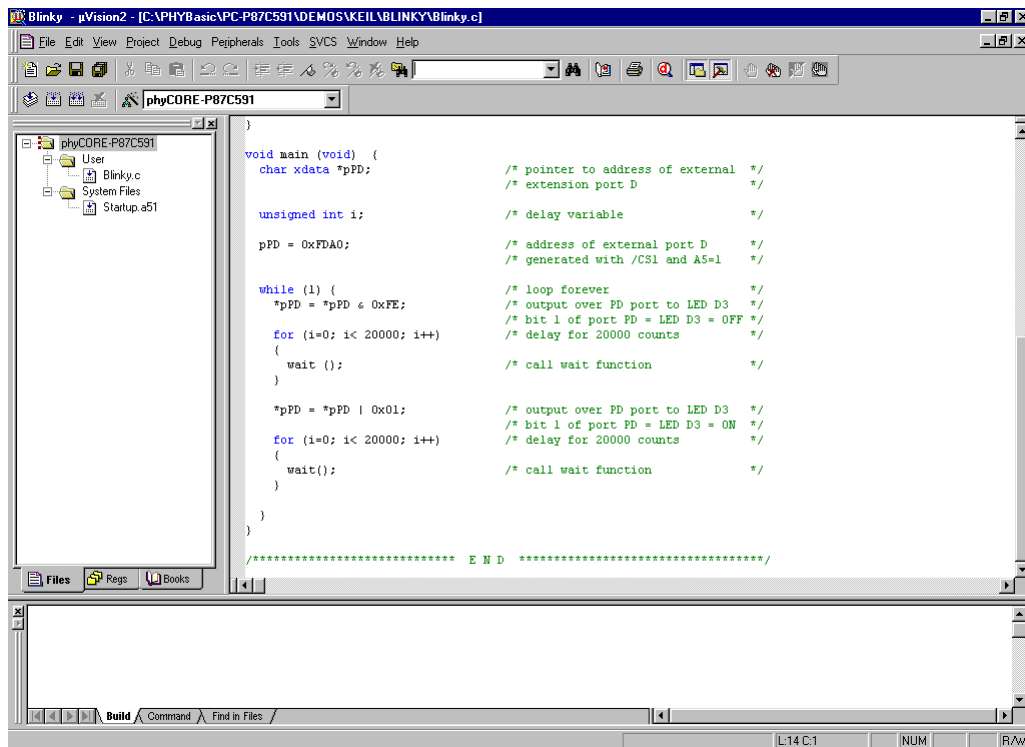

```
void main (void) {
    char xdata *pPD;          /* pointer to address of external */
                             /* extension port D */

    unsigned int i;         /* delay variable */

    pPD = 0xFDA0;           /* address of external port D */
                             /* generated with /CS1 and A5=1 */

    while (1) {             /* loop forever */
        *pPD = *pPD & 0xFE; /* output over PD port to LED D3 */
                             /* bit 1 of port PD = LED D3 = OFF */
        for (i=0; i< 20000; i++) /* delay for 20000 counts */
        {
            wait ();          /* call wait function */
        }

        *pPD = *pPD | 0x01;  /* output over PD port to LED D3 */
                             /* bit 1 of port PD = LED D3 = ON */
        for (i=0; i< 20000; i++) /* delay for 20000 counts */
        {
            wait();          /* call wait function */
        }
    }
}

/***** E N D *****/
```

- Locate the following code section. Modify the section shown below (the values shown in bold and italic) from the original (20,000) counts to the indicated values:

```
while (1) {
    *pPD = *pPD & 0xEF;          /* loop forever          */
                                /* output over PD port to LED D3 */
                                /* bit 1 of port PD = LED D3 = OFF */
    for (i=0; i< 20000; i++) /* delay for 20000 counts */
    {
        wait ();                /* call wait function      */
    }
    *pPD = *pPD | 0x10;         /* output over PD port to LED D3 */
                                /* bit 1 of port PD = LED D3 = ON  */
    for (i=0; i< 40000; i++) /* delay for 40000 counts */
    {
        wait();                 /* call wait function      */
    }
}
```

This will change the LED on/off ratio.

3.4 Saving the Modifications

- Save the modified file by choosing *File/Save* or by clicking the floppy disk icon  .

3.5 Setting Tool Chain Options

Keil includes a Make utility that can control compiling and linking source files in several programming languages. Before using the Make utility, macroassembler, C compiler or linker you must configure the corresponding options. Most of the options are set by specifying the target device for the project. Only the external memory and output options must be set.

Enter the changes as indicated below and leave all other options set to their default values. μ Vision2 allows you to set various options with mouse clicks and these are all saved in your project file.

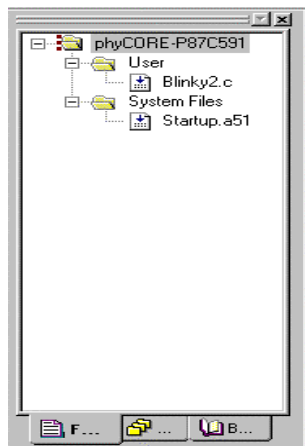

- Select the target *phyCORE-P87C591* within the project window.

To configure the Target:

- Open the *Project/Options for Target 'phyCORE-P87C591'* menu and change the default settings to the correct values for the phyCORE-P87C591 as shown in the figure below. This includes settings for the clock frequency of your phyCORE module, the memory model and the off-chip memory.

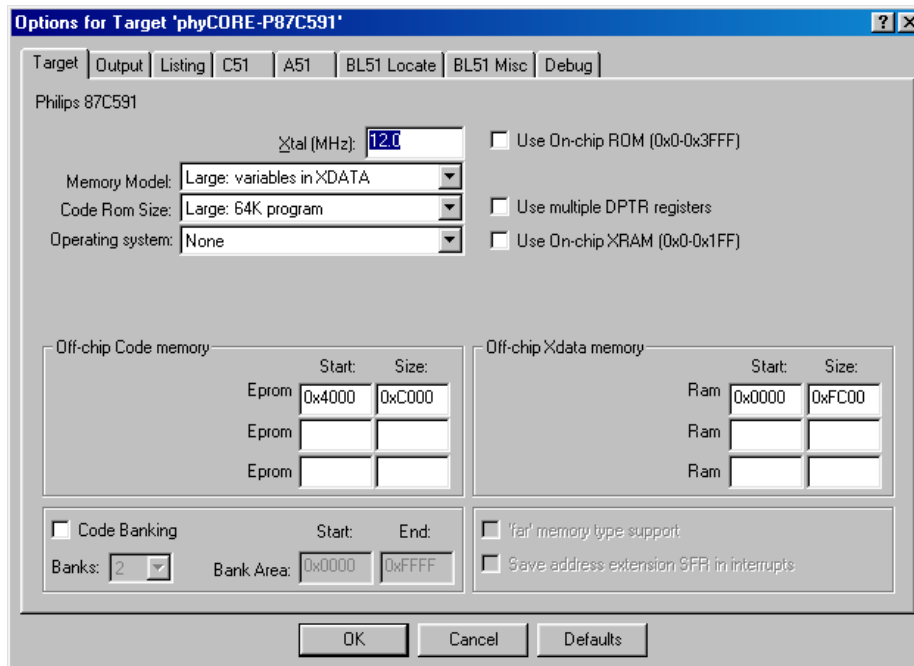

- The phyCORE-P87C591 is populated with a 64 kByte linear accessible SRAM device. This allows selection of the *Large: variables in XDATA* memory model.

The evaluation version of the Keil tool chain automatically relocates CODE to start address 0x4000⁶. The XDATA memory can be configured in the range starting at 0x0000 with a maximum size of 0xFC00. The memory range between 0xFC00 and 0xFFFF is reserved for the address decoder registers and the I/O Chip Select signals on the phyCORE-P87C591. This address range may not be used as XDATA memory.

⁶: Even if a lower start address is configured in the target code memory dialog, the linker will automatically relocate the CODE sections to 0x4000 in the Keil μ Vision2 evaluation version.

To configure the Output options:

- Select the **Output** tab and activate the **Create HEX File** checkbox. With this option an Intel ***.hex** file will be created for download.

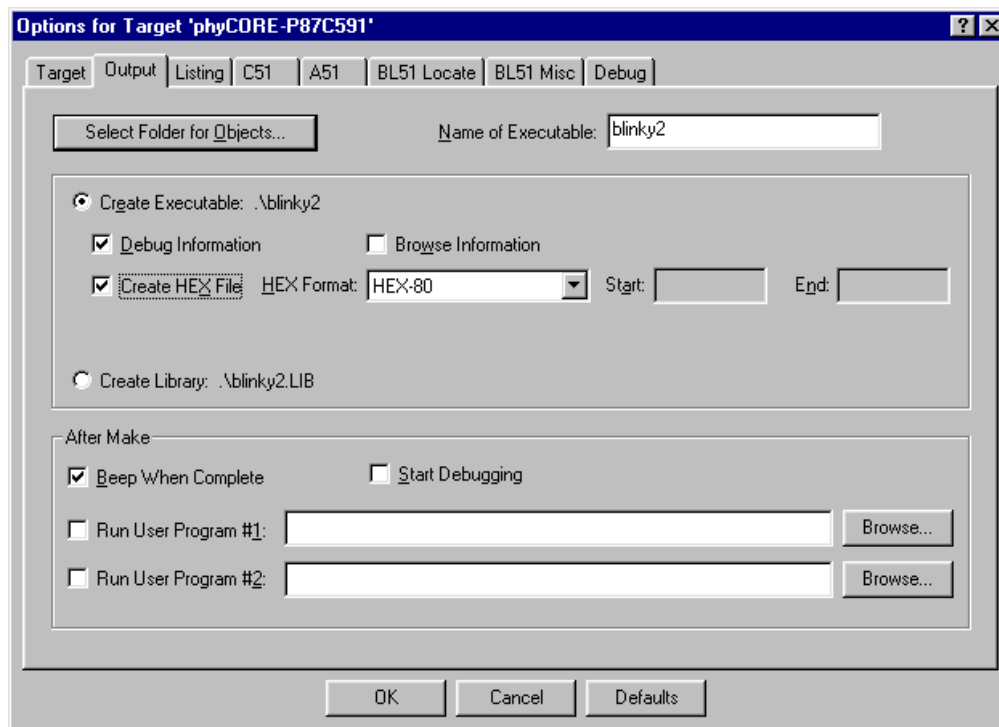

- Click on **OK**.

3.6 Building the Project

You are now ready to run the compiler and linker using the Make utility.

- Click on the *Build Target* icon  from the µVision2 toolbar or press <F7>.

If the program specified (*Blinky2.c*) contains any errors, they will be shown in an error dialog box on the screen.

If there are no errors, the code is compiled and linked and the executable code is ready to be downloaded to the module. This is shown in the *Output Window*, which indicates "*Blinky2*" - 0 Errors, 0 Warnings. The created hexfile will have the name of the project with *.hex* as the filename extension (in this case *Blinky2.hex*).

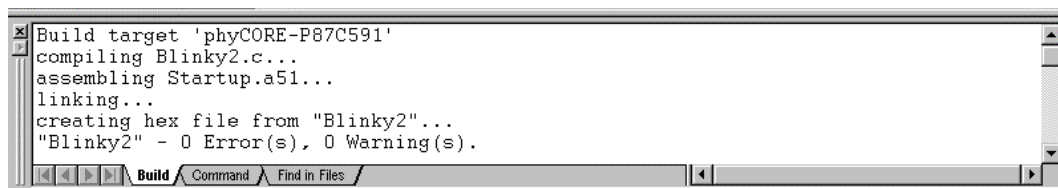

```
Build target 'phyCORE-P87C591'
compiling Blinky2.c...
assembling Startup.a51...
linking...
creating hex file from "Blinky2"...
"Blinky2" - 0 Error(s), 0 Warning(s).
```

Note:

A machine-readable, executable hexfile has been created. Other files (e.g. list files **.lst* and map files **.map*) are generated to help the debugging or troubleshooting and error searching process.

- If a list of errors appears, use the editor to correct the error(s) in the source code, save the file and (re-)build the project.

3.7 Downloading the Output File

- Exit Keil μ Vision2.
- Reset the target hardware and force it into Flash programming mode by simultaneously pressing the Reset (S2) and Boot (S1) buttons on the phyCORE Development Board LD 5V and then releasing first the Reset and, two or three seconds later, the Boot button.
- Start FlashTools98.
- At the *Communication Setup* tab of the FlashTools98 tabsheet, specify the proper serial port and transmission speed (9,600 Baud) for communication between host-PC and target hardware and click the *Connect* button to establish connection to the target hardware.
- Returning to the FlashTools98 tabsheet, choose the *Bank Utilities* tab, highlight *Bank #1* within the *Bank Erase* section, and click on the *Erase Bank(s)* button to erase this memory bank.
- Wait until the status check in the lower left corner of the FlashTools98 tabsheet finishes, returning the connection properties description to the lower left corner of the window.
- Next choose the *File Download* tab and click on the *File Open* button.
- Browse to the correct drive and path for the phyCORE-P87C591 Demo folder (default location **C:\PHYBasic\pC-P87C591\Demos\Keil\Blinky2\Blinky2.hex** and click *Open*.
- Click on the *Download* button and view the download procedure in the status window.
- Returning to the *Communication* tab, click on the *Disconnect* button and exit FlashTools98.
- Press the Reset button (S2) on the Development Board.

If the modified hexfile properly executes, the LED should now flash in a different mode with different on and off durations.

You have now modified source code, recompiled the code, created a modified downloadable hexfile, and successfully executed this modified code.

3.8 “Hello2”

A return to the “Hello” program allows a review of how to modify source code, create and build a new project, and download the resulting output file from the host-PC to the target hardware. For detailed commentary on each step, described below in concise form, refer back to the “Blinky2” example starting at section 3.1.

3.8.1 Creating a New Project

- Start the Keil μ Vision2 environment and close all projects that might be open.
- Open the **Project** menu and create a new project called **Hello2.uv2** within the existing project folder **C:\PHYBasic\pC-P87C591\Demos\Keil\Hello2** (default location) on your hard-drive. Select the Philips 87C591 in the CPU vendor data base list.
- Add **Hello2.c**, **Serinit.lib** and **Startup.a51** from within the project folder to the project **Hello2.uv2**.
- Your project window should now look like this:

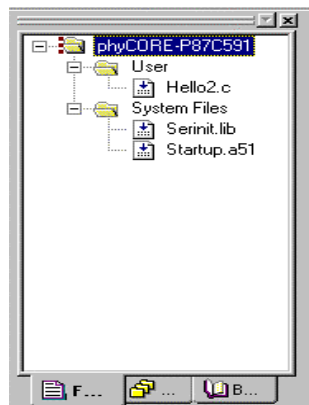

- Save the project.

At this point you have created a project called **Hello2.uv2** consisting of a C source file called **Hello2.c**, a library called **Serinit.lib** and an assembler file called **Startup.a51**.

3.8.2 Modifying the Example Source

- Double-click the file ***Hello2.c*** from within the project window.
- Use the editor to modify the *printf* command:

```
printf ("\x1AHello World\n")
```

to

```
printf ("\x1APHYTEC... Stick It In!\n")
```

- Save the modified file under the same name ***Hello2.c***.

3.8.3 Setting Tool Chain Options

- Open the ***Project/Options for Target...*** menu and change the default settings to the correct values as shown in *section 3.5*. This includes settings for the clock frequency of your phyCORE module, the memory model (make sure “*Large: variables in XDATA*” is configured) and the off-chip memory.
- Modify the default options for the output file by selecting the ***Create HEX File*** checkbox in the ***Project/Options for Target..../Output*** tab. This will automatically create a hexfile for download to the phyCORE-P87C591 after compiling.

3.8.4 Building the New Project

- Build the project.
- If any source file in the project contains errors, they will be shown in an error dialog box on the screen. Use the editor to correct the error(s) in the source code, save the file and (re-)build the project.

If there are no errors, the code is assembled and linked and the executable code is ready to be downloaded to the board.

3.8.5 Downloading the Output File

- Exit Keil μ Vision2.
- Reset the target hardware and force it into Flash programming mode by simultaneously pressing the Reset (S2) and Boot (S1) buttons on the phyCORE Development Board LD 5V and then releasing first the Reset and, two or three seconds later, the Boot button.
- Start FlashTools98.
- At the *Communication Setup* tab of the FlashTools98 tabsheet, specify the proper serial port and transmission speed (9,600 baud) for communication between host-PC and target hardware and click the *Connect* button to establish connection to the target hardware.
- Returning to the FlashTools98 tabsheet, choose the *Bank Utilities* tab, highlight *Bank #1* within the *Bank Erase* section, and click on the *Erase Bank(s)* button to erase this memory bank.
- Wait until the status check in the lower left corner of the FlashTools98 tabsheet finishes, returning the connection properties description to the lower left corner of the window.
- Next choose the *File Download* tab and click on the *File Open* button.
- Browse to the correct drive and path for the phyCORE-P87C591 demo folder (default location **C:\PHYBasic\pC-P87C591\Demos\Keil\Hello2\Hello2.hex** directory (default location)).
- Click on the *Download* button and view the download procedure in the status window.
- Returning to the *Communication* tabsheet, click on the *Disconnect* button and exit FlashTools98.

3.8.6 Starting the Terminal Emulation Program

- Start HyperTerminal and connect to the target hardware using the following COM parameters: Bits per second = 9600; Data bits = 8; Parity = *None*; Stop Bits = 1; Flow Control = *None*.
- Resetting the phyCORE Development Board LD 5V (at S2) will execute the ***Hello2.hex*** file loaded into the Flash.
- Now push the <Space> bar on your keyboard once to start the automatic baud rate detection on phyCORE-P87C591 module.
- Successful execution will send the modified character string "**PHYTEC... Stick It In!**" to the HyperTerminal window.
- Click the Disconnect icon .
- Close the Hyper Terminal program.

You have now modified source code, recompiled the code, created a downloadable hexfile, and successfully executed this modified code.

4 Debugging

This Debugging section provides a basic introduction to the debug functions included in the Keil software evaluation development tool chain. Using an existing example, the more important features are described. For a more detailed description of the debugging features, please refer to the appropriate manuals provided by Keil.

The μ Vision2 Debugger offers two operating modes that can be selected in the *Project/Options for Target phyCORE-P87C591* dialog:

- The **Simulator** allows PC-based microcontroller simulation of most features of the 8051 microcontroller family without actually having target hardware. You can test and debug your embedded application before the hardware is ready. μ Vision2 simulates a wide variety of peripherals, including the serial port, external I/O, and timers. The peripheral set is selected when you select a CPU from the device database for your target.
- Advance GDI drivers, like the **Keil Monitor 51** interface, allow target-based debugging. With the Advanced GDI interface you may connect directly to the target hardware. Debugging on the target hardware also enables testing peripheral components.

The following examples utilize the Keil Monitor 51 interface.

Note:

Use of the monitor program requires protection (reservation) of some controller resources, such as the serial interface, the serial interrupt and timer 1. These resources are necessary to allow communication between the monitor program on the target hardware and the μ Vision2 Debugger (*refer to the Keil Getting Started Manual for further information*). Do not use these resources when developing an application program to be debugged using the Keil Monitor 51 interface.

Before using the Keil Monitor 51 interface, a special *.hex file (the monitor firmware) must be downloaded to the target hardware.

4.1 Preparing the Target Hardware to Communicate with μ Vision2 Target Monitor

- Ensure that the target hardware is properly connected to the host-PC and a power supply.
- Reset the target hardware and force it into Flash programming mode by simultaneously pressing the Reset (S1) and Boot (S2) buttons on the Development Board and then releasing first the Reset and, two or three seconds later, the Boot button.
- Start FlashTools98 for Windows.
- At the *Serial Interface* tab of the FlashTools98 tabsheet, specify the proper serial port and transmission speed for communication between host-PC and target hardware and click the *Connect* button to establish connection to the target hardware.
- Returning to the FlashTools98 tabsheet, choose the *Bank Utilities* tab, highlight *Banks #1* and click on the *Erase Bank(s)* button.
- Next choose the *File Download* tab and click on the *File Open* button.
- Download the file *mon51.hex* from the *Tools* folder **C:\PHYBasic\pC-P87C591\Tools\Keil\Mon\64k** (default location).

The PHYTEC Spectrum CD-ROM may also contain other versions of the *mon51.hex* monitor file. These version are made for different oscillator frequencies and memory options of the phyCORE module. The files are available in **C:\PHYBasic\pC-P87C591\Tools\Keil\Mon** within various subdirectories. *Please refer to readme files within the directories for details.*

- Click on the *Download* button and view the download procedure in the status window.

If download is successful, the monitor kernel has been programmed into the external Flash memory. The target hardware is now prepared to communicate with the Keil μ Vision2 debugging tools installed on the host-PC.

- Disconnect from the target hardware after the download has finished either by clicking the *Disconnect* button on the *Communication Setup* tabsheet or choosing the *Connect/Disconnect* icon from the FlashTools98 toolbar.
- Exit FlashTools98.

4.2 Creating a Debug Project and Preparing the Debugger

4.2.1 Creating a New Project

- Start the Keil μ Vision2 environment and close all projects that might be open.
- Open the Project menu and create a new project called *Debug.uv2* within the existing project directory *C:\PHYBasic\pC-P87C591\Demos\Keil\Debug* (default location) on your hard drive. Select the Philips 87C591 in the CPU vendor data base list.
- Rename the target of your project within the **Project Window – Files** tab into *phyCORE-P87C591*.
- Rename the file group *Source Group 1* within the **Project Window – Files** tab into *User* and add an additional file group named *System Files*.
- Add *Debug.c* and *Serinit.lib* to the file group *User* and *Startup.a51* to the file group *System Files* from within the project folder.
- Your project should now look like this:

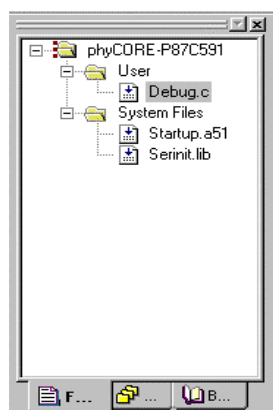

- Save the project.

At this point you have created a project called ***Debug.uv2***, consisting of a C source file called ***Debug.c***, the ***Serinit.lib*** library file and the assembler file ***Startup.a51***. The ***Serinit.lib*** library file contains functions for the serial communication between the target hardware and the host-PC as well as the automatic baudrate detection feature.

4.2.2 Setting Options for Target

When setting the memory configuration, the memory layout necessary for the monitor must be taken into consideration.

The standard 8051 controller uses a Harvard memory architecture. In this architecture, access to CODE and XDATA memory space goes to physically different memory devices. Normally, for access to CODE space, a non-volatile memory is utilized, i.e. ROM or Flash. For access to XDATA space, a RAM is used. Using this memory model with an 8051 derivative allows access to up to 64 kByte of memory for CODE and 64 kByte for XDATA.

When debugging with the Keil monitor, it is important that the user program (CODE) can be changed during runtime (e.g. to enable setting of breakpoints). This requires the user program to be stored in RAM and **not** in Flash. In order to ensure that the user program is running in RAM, the monitor automatically configures a von Neumann memory architecture in the address range 0000H-DFFFH after reset. Here, in contrast to the Harvard architecture, access to CODE and XDATA space is directed towards the same physical memory device, normally RAM. With this von Neumann memory architecture, it is now possible to change the application program during runtime.

The following figure (see Figure 5) depicts the memory layout that is configured by the Keil monitor for 64 kByte RAM.

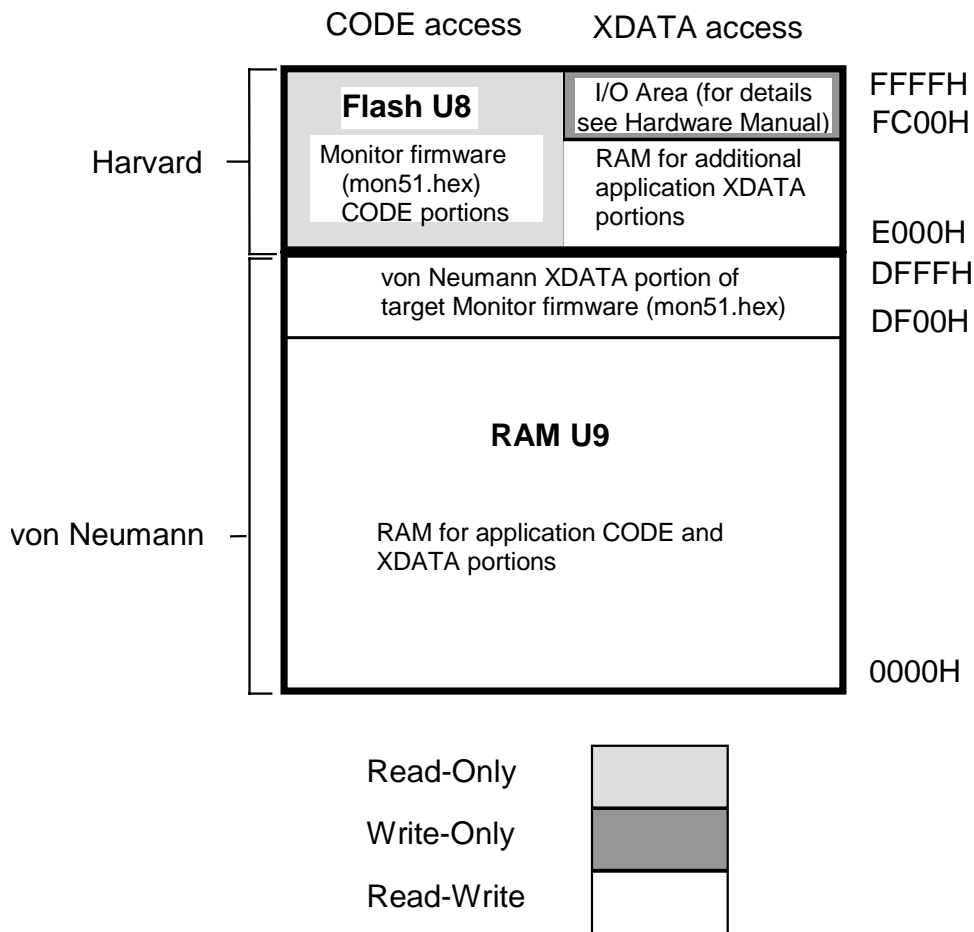
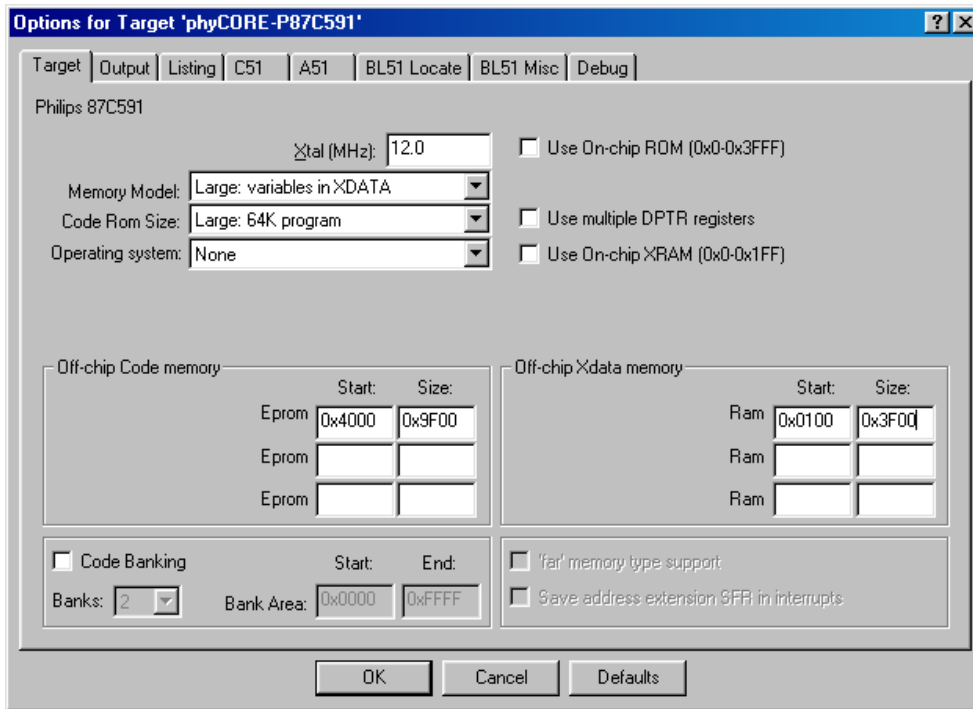

Figure 5: Memory Model for Use with the Keil Monitor (64 kByte RAM)

Note:

When using the von Neumann memory architecture, ensure that the CODE and XDATA areas within the application program do **not** overlap. This is important because otherwise portions of the program (CODE) will be overwritten by e.g. variables (XDATA), resulting in an error when executing user code.

- Open the **Project/Options for Target 'phyCORE-P87C591'** menu and change the default settings to the correct values as shown in the figure below. This includes settings for the clock frequency of your phyCORE module, the memory model (make sure “*Large: variables in XDATA*” is configured) and the off-chip memory⁷.



The memory ranges for off-chip CODE and off-chip XDATA memory are configured to fit within the von Neuman memory space as configured by the the Keil *mon51.hex* monitor file (refer to Figure 5). In addition, the restrictions for the off-chip CODE memory start address in the evaluation version of the Keil tool chain must be considered. The start address of the XDATA memory should be at 0x100 in order to avoid conflicts with the interrupt/reset vector table which is located between 0x0 and 0xFF.

⁷ Ensure that the CODE and XDATA memory do not overlap.

Note: When using the evaluation version of the Keil tool chain, the start address of the CODE memory must be at 0x4000 or higher. When using the full version of the Keil tool chain, the start address of the CODE memory should be at 0x100. This avoids conflicts with the interrupt/reset vector table which is located between 0x0 and 0xFF. The XDATA memory can then be located in a higher address range. Again, ensure that the CODE and XDATA memory do not overlap.

- Select the **Output** tabsheet and enable the **Browse Information** checkbox. This will include additional browser information into the object files that can be viewed with the **Source Browser** included in Keil μ Vision2.

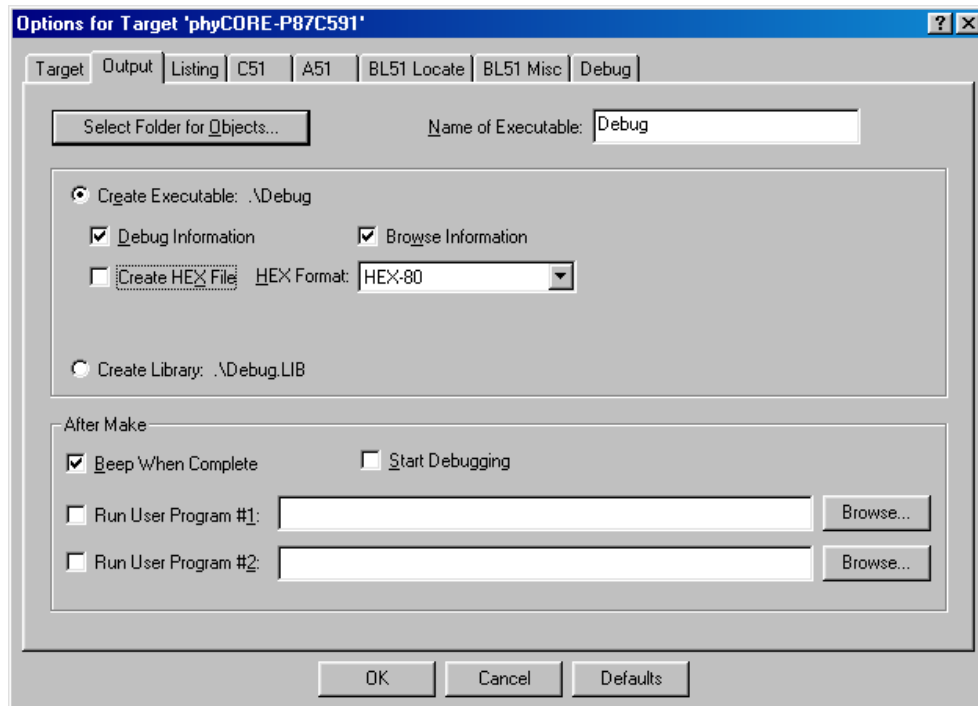

The compilation of the *Debug.c* program can be controlled with the two *define* statements **MONITOR51** and **INTERRUPT**. Setting the *define* **MONITOR51** reserves space for the serial interrupt and disables the configuration of the serial interface by the *Debug.c* program. This is necessary to avoid overwriting the configuration done by the monitor kernel. The *define* **INTERRUPT** disables all serial output of the *Debug.c* program. If debugging is controlled with the serial interrupt, (see settings for the Keil Monitor 51 Driver in section 4.3) any serial input and output of the user application conflicts with the communication of the monitor program. Such serial communication functions cannot be active in user code to ensure proper debugging.

- Select the **C51** tabsheet and add **MONITOR51** in the *Define:* input field⁸. Adjust the settings for *Code Optimization* to the settings shown in the figure below.

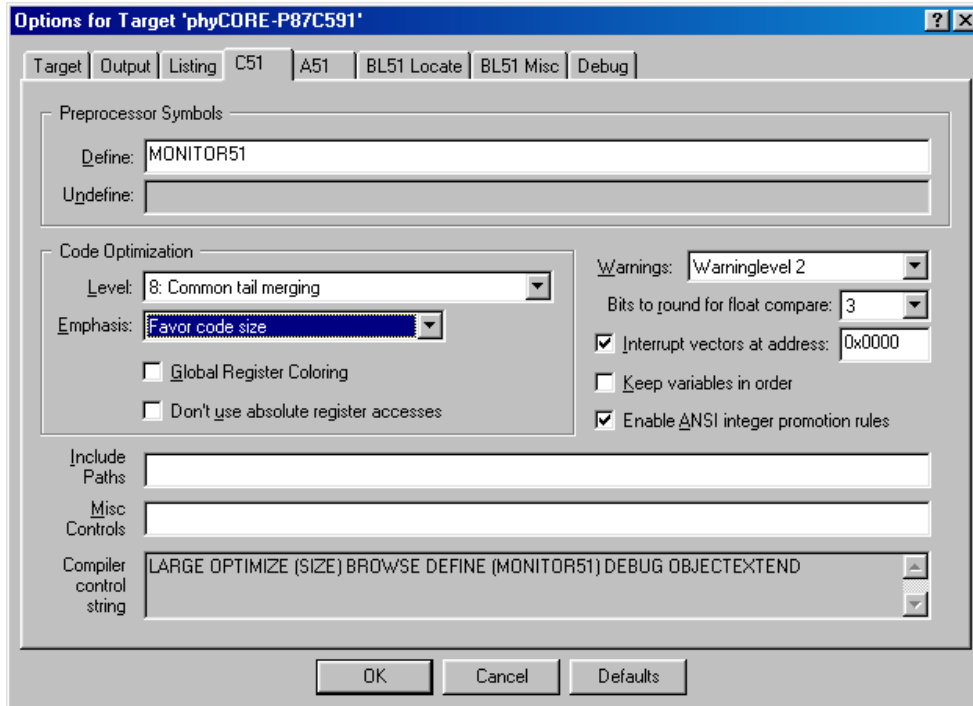

- Ensure that the configurations on the **Listing**, **A51**, **BL51 Locate** and **BL51 Misc** tabsheets are set to their default settings.
- Click the **OK** button to save the settings.
- Click on the **Rebuild all target files**  button to compile and link your project.

⁸: Please note that this example only requires the *define* **MONITOR51** in order to use the serial output.

4.3 Preparing the Debugger

According to the *Project/Options for Target 'phyCORE-P87C591'* configuration, μ Vision2 will load the application program and run the startup code.

- Open the *Project/Options for Target 'phyCORE-P87C591'* menu and select the *Debug* tabsheet.
- Enable the checkboxes *Use: Keil Monitor-51 Driver* and *Load Application at Startup*. Disable the checkbox *Go till main()*.

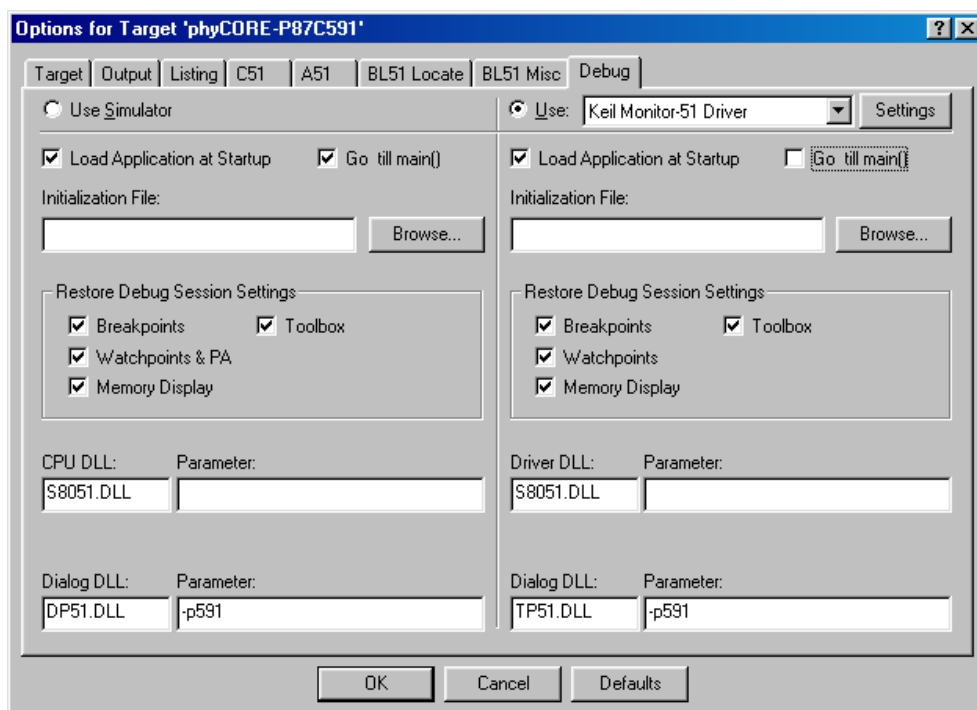

- Click on the **Settings** button in the upper right-hand corner of the **Debug** tabsheet.
- Select the correct COM port and baud rate in the *COM Port Settings* as shown below.
- Ensure that *Serial Interrupt* checkbox is disabled.

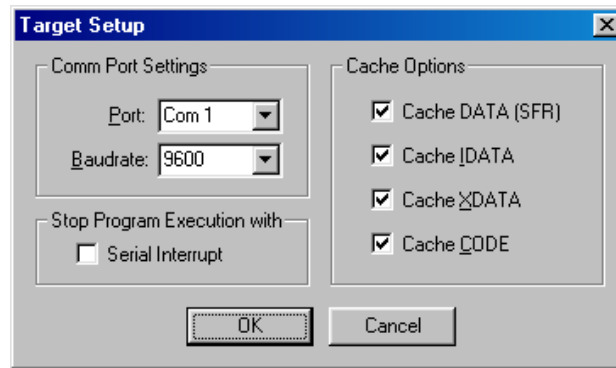

- Click on the *OK* button to exit the *Target Setup* window.

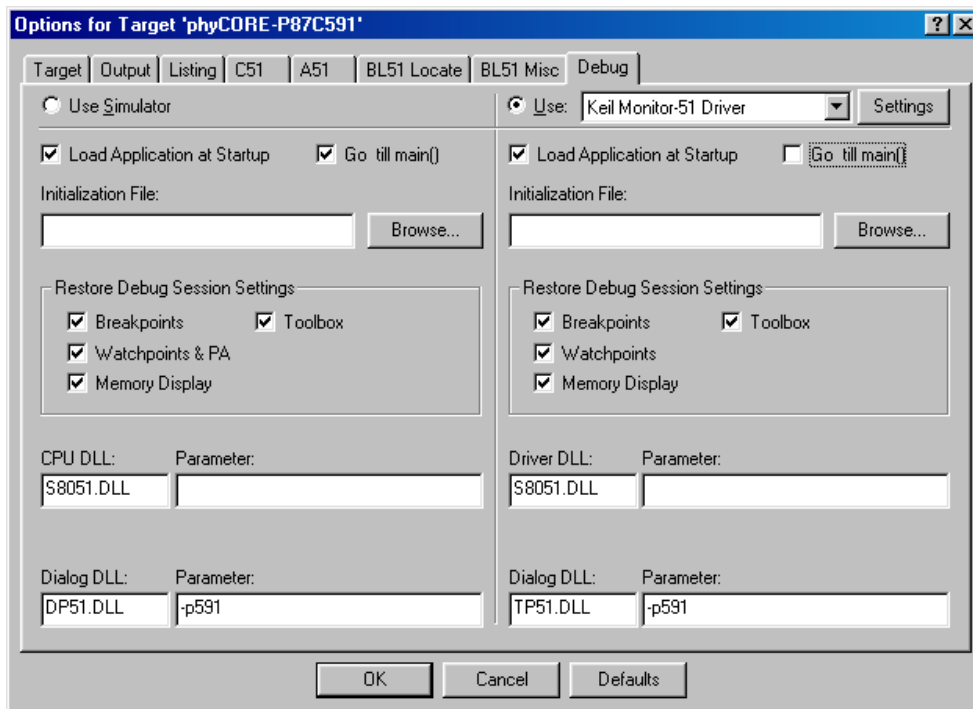

- Click on the *OK* button again.

4.4 Starting the Debugger

- Before starting the Debugger on the host-PC, press the Reset button (S1) on the phyCORE Development Board LD 5V to start the previously downloaded monitor kernel.
- To start the μ Vision2 debug environment, click on the debugger icon  on the μ Vision2 toolbar. A pop-up window will appear indicating that this is an evaluation version. Click on *OK*.

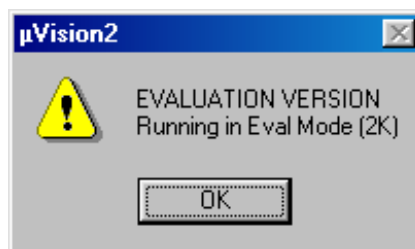

- You will see a blue status bar from left to right at the bottom of your screen indicating the download process of the debug program.

If a problem occurs during data transfer, the following window will appear:

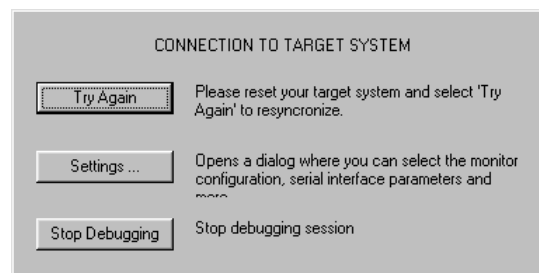

- Click on *Settings* and verify the COM port and the baud rate (9,600 baud). Push the Reset button S2 on the phyCORE Development Board LD 5V and click on *Try Again*.

If the data transfer was successful, a screen similar to the one shown below will appear. The **Project** window changed to the **Register** page. The debug toolbar is also displayed. The **Serial** window is located below the **Project** window. It shows all serial output of the debug program. In the lower part of the debug screen you will see the **Command**, **Memory** and **Watch/Stack** window.

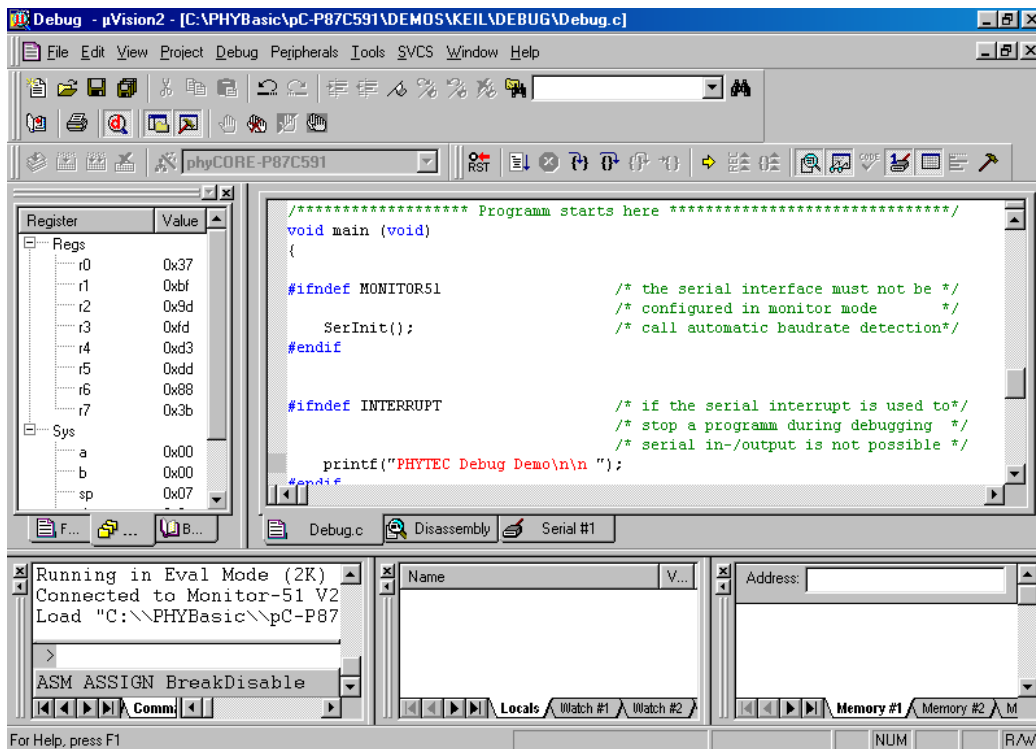

You may need to open, resize and /or move some windows to make your screen look similar to the screen capture. You can open inactive windows by choosing the desired window from the **View** pull-down menu. The following screen capture has **Workbook Mode** enabled to allow easy access to various overlapped windows with tabs.

- Before starting the program, point the mouse at the *constant* named "**rhythm[]**". A small window appears and displays the address where *rhythm* is stored and its current value is shown. The *constant* is not yet initialized and the value is therefore random.

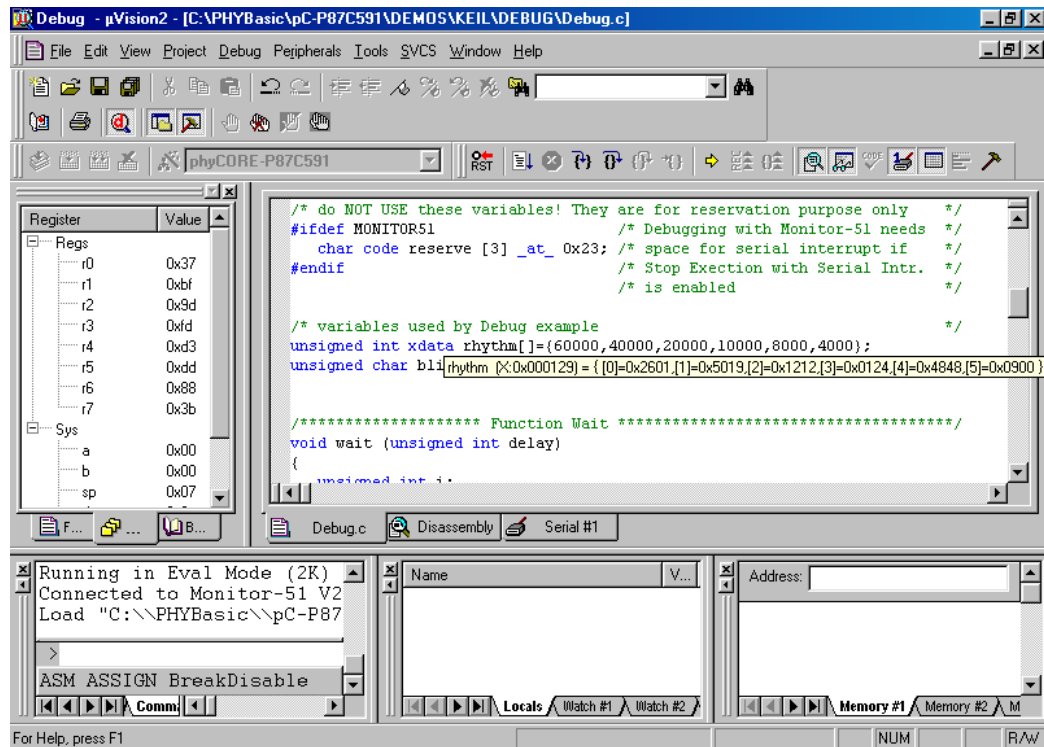



- In the *Command* window prompt in the lower left corner, type in *g,main* (notice the comma!) and press <Enter> to start the program.

The debugger will run to the 'main' function and stop automatically. Notice the yellow arrow pointing to the first command in the 'main' function. Also notice the program counter (PC \$) within the **Project Window – Register** page showing the start address of the 'main' function.

4.5 Keil μ Vision2 Debug Features

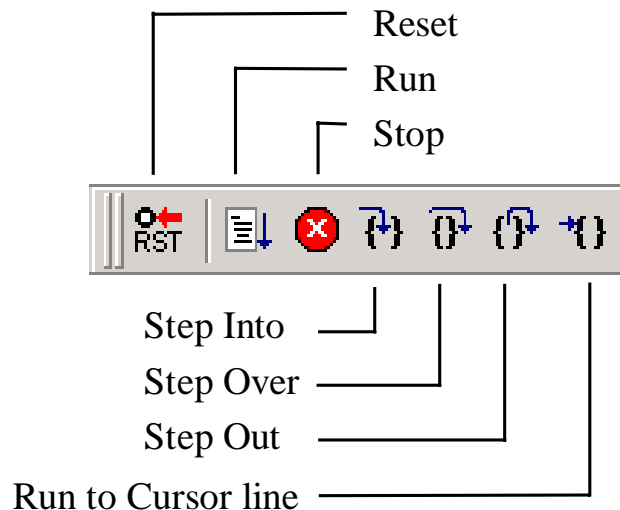
- The *Debugger* window toolbar gives access to the following debug commands: *Reset*, *Run*, *Stop*, *Step Into*, *Step Over*, *Step Out* and *Run to Cursor line*.



- The first button on the debugger toolbar is the *Reset*  button.

The *Reset* command sets the program counter to 0. However, it should be noted that peripherals and SFRs of 8051 devices are not set into reset state. Therefore this command is not identical to a hardware reset of the CPU.

- The button to the right of the *Reset* button starts the *Run*  command.

Clicking this button runs the program without active debug functions. To stop program execution at a desired point, a breakpoint can be placed before the *Run* button is pushed.

- The next button on the debugger toolbar is the *Stop*  button.

The *Stop* button interrupts and stops the running program at an undetermined location.

- The first button allowing exact control of the program execution is the *Step Into*  button.

The *Step Into* command performs the execution of the command line to which the *Current-Statement Arrow*  points. This can be a C command line or a single assembler line, depending on the current display mode. If the command line is a function call, *Step Into* jumps to the C function or subroutine, enabling you to explore the code contained in the accessed subroutine.

- The *Step Over*  button is next on the debugger toolbar.

The *Step Over* command executes the command line, to which the *Current-Statement Arrow*  points. This can be a C command line or a single assembler line, depending on the current display mode. If the command line is a function call, the function will be executed without single stepping into the function.

Note:

We recommend not using the *Step Over* function with the monitor. During compiling of the C code, the compiler runs through the optimization steps. This optimization summarizes calls of nested functions and their return jump to the original function in the compiled machine code. This can effect a *Step Over* command by nesting multiple calls for sequential functions. For users with assembler knowledge, the *View->Disassembly* window is recommended. Here the C source code contrasts with the machine code and the optimization steps are obvious.

- The next button is the *Step Out*  button.

Step Out is used to exit a function you are currently in. *Step Out* is very useful if you find yourself in a function you are not interested in and need to return quickly to your intended function.

Note:

Due to performance reasons the *Step Out* command is not available in monitor mode. *Step Out* is only available in the simulator mode.

- The last button  on the debugger toolbar performs the *Run to Cursor line* command.

The *Run to Cursor line* command executes the program to the current cursor position within the code window. This allows use of the cursor line as a temporary breakpoint.

4.6 Using the Keil μ Vision2 Debug Features

4.6.1 Serial Window

- Click on the *Step Into*  button. The **printf** command will be executed and the serial output will appear in the *Serial #1* window of the debugger.

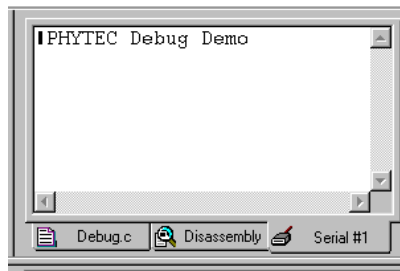

4.6.2 Breakpoints

- Click in the line where the ‘wait’ function is called for the first time.
- Click on *Insert/Remove Breakpoint*  to set a breakpoint here. The red marker on the left-hand side of the selected line indicates the breakpoint.

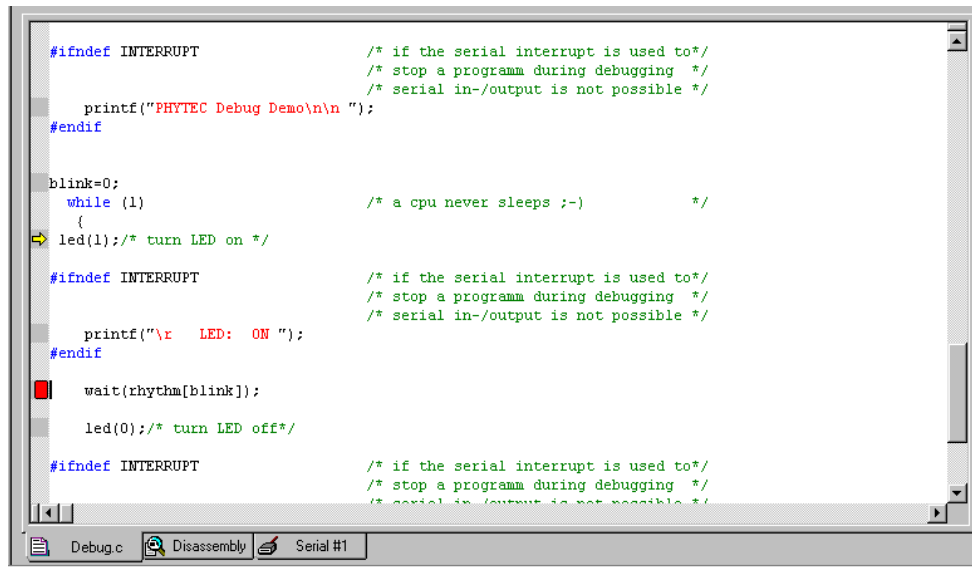



```

#ifndef INTERRUPT                /* if the serial interrupt is used to*/
                                /* stop a programm during debugging */
                                /* serial in-/output is not possible */
    printf("PHYTEC Debug Demo\n\n");
#endif

blink=0;
while (1)                        /* a cpu never sleeps ;- )          */
{
    led(1); /* turn LED on */
    #ifndef INTERRUPT            /* if the serial interrupt is used to*/
                                /* stop a programm during debugging */
                                /* serial in-/output is not possible */
        printf("\r LED: ON ");
    #endif
    wait(rhythm[blink]);
    led(0); /* turn LED off*/
    #ifndef INTERRUPT            /* if the serial interrupt is used to*/
                                /* stop a programm during debugging */
                                /* serial in-/output is not possible */

```

- Click on the *Run*  icon and the program will run and stop at the breakpoint.
- Notice that the LED (D3) on the Development Board now illuminates. This is because the *led(0)* function call has been executed and the status of the LED is shown in the *Serial* window.
- Click again on *Insert/Remove Breakpoint*  to remove the breakpoint.

4.7 Single Stepping and Watch Window

- Click on the **Step Into**  icon to enter the 'wait' function.
- The **Watch** window automatically shows the value of the two local variables; *delay* and *i*. In order to change the number base from hexadecimal to decimal, right-click on the variable you want to change.

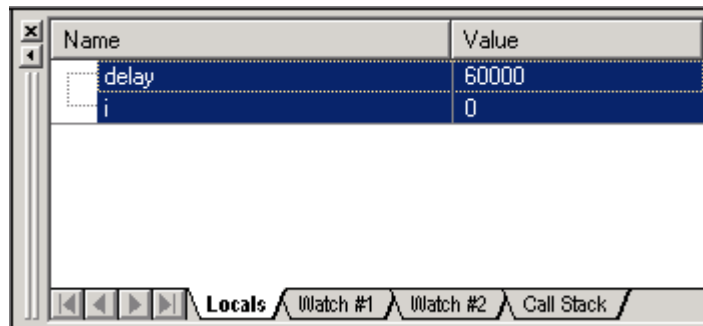

- Click **Step Into** several times and watch the value of *i* count up.
- As you can see in the source code, the for{ } loop will end if *i* becomes equal to *delay*. To leave the *wait* function, change the value of *i* by typing ***i=59996*** in the command line and pressing <Enter>. Now repeat clicking on **Step Into** until you leave the wait function.

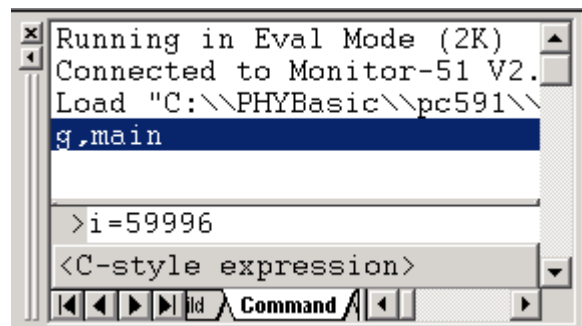

- Click in the source code line *blink++* and choose **Run to Cursor line** from the debug toolbar. Your program will be executed until it reaches this line.
- Notice that the LED D3 on the Development Board is off now and the new status of the LED is shown in the **Serial** window.

- As a last example, the constant "**rhythm[]**" will be evaluated. Go to the source code line where the constant "**rhythm[]**" is declared. Right-click on "**rhythm[]**" and choose the "**ADD rhythm to watch window**" -> #1 option. Select the "**Watch #1**" tabsheet at the bottom of the watch window. The constant is shown with its address and a small \oplus sign in front which indicates that "**rhythm[]**" is an array with a group of array elements. Click the \oplus sign to expand the view and to see all array elements of "**rhythm[]**".

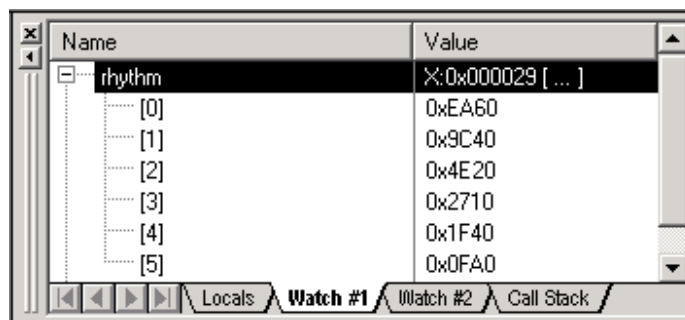

Using the memory address of *rhythm*, which is shown in the watch window, it is also possible to view the values of the array elements in the *Memory* window.

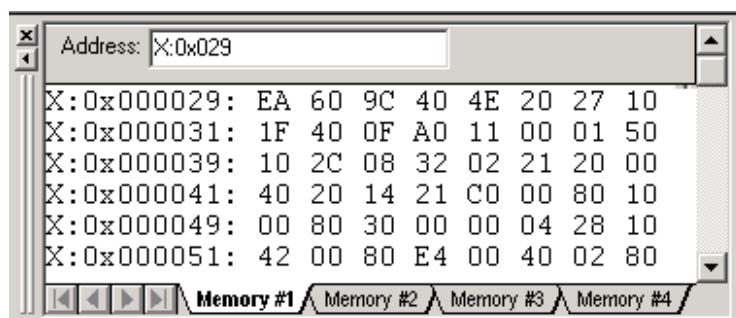

- Type X: 0x0129 in the *Address:* line of the *Memory* window and press <Enter>.

A memory area starting at address 0x0129 of the external memory is now displayed in the *Memory* window.





- The passing of the array element to the wait function can be viewed whenever you step into the wait function. After stepping into the wait function you will find one of the elements in registers R6 and R7.

4.8 Running, Stopping and Resetting

- To run your program without stopping at any time, delete all breakpoints by clicking on the  button.
- Click the **Run**  button.

The LED now blinks and its current status is displayed in the *Serial* window.

Use of the **Stop**  button is not possible as this example utilizes functions for the RS-232 communication within the application code. To stop program execution, leave the debugger and press the Reset button on the phyCORE Development Board LD 5V.

If you want to use the **Stop**  button, the serial output of the debug program must be disabled. To do so, add **INTERRUPT** in the *Define:* input field within the *C51* tabsheet before rebuilding the project and enable the *Serial Interrupt* in the *Target Setup* window for the debugger.

4.9 Changing Target Settings for the "Final Version"

After successfully debugging the program, next change the target settings in order to create an Intel hexfile. This can then be downloaded to the Flash memory of the phyCORE-P87C591.

- Open the **Project/Options for Target 'phyCORE-P87C591'** menu and change the settings for off-chip memory to the new values as shown in the figure below. Since this program code is intended for execution out of Flash rather than running in the Keil *mon51.hex* monitor, the complete range of available memory can be used.

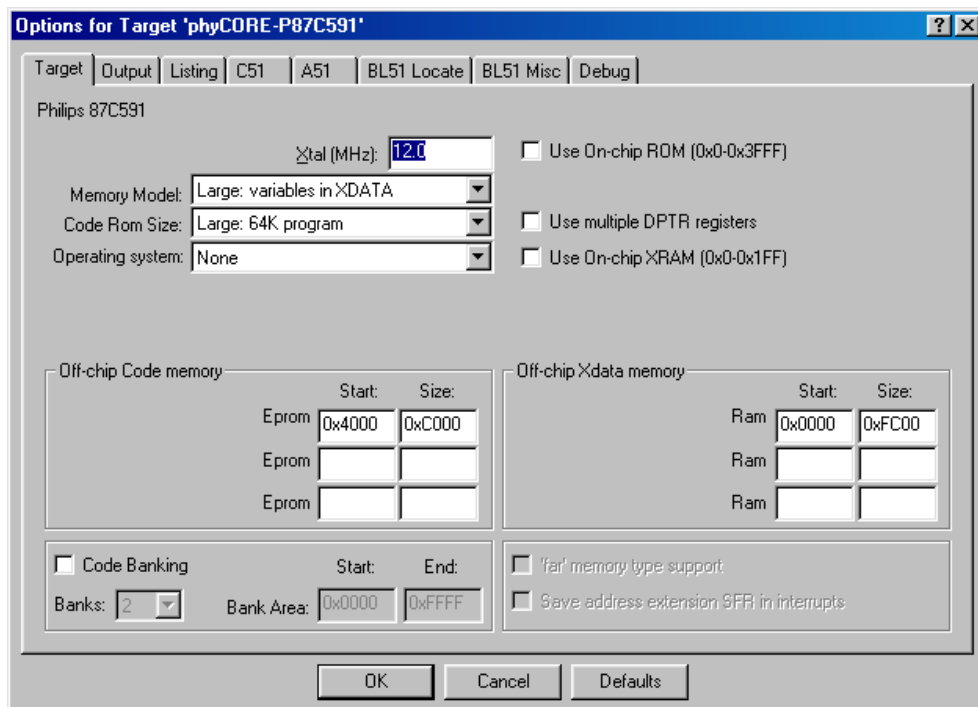

- Select the **Output** tabsheet and enable the checkbox *Create HEX File*.

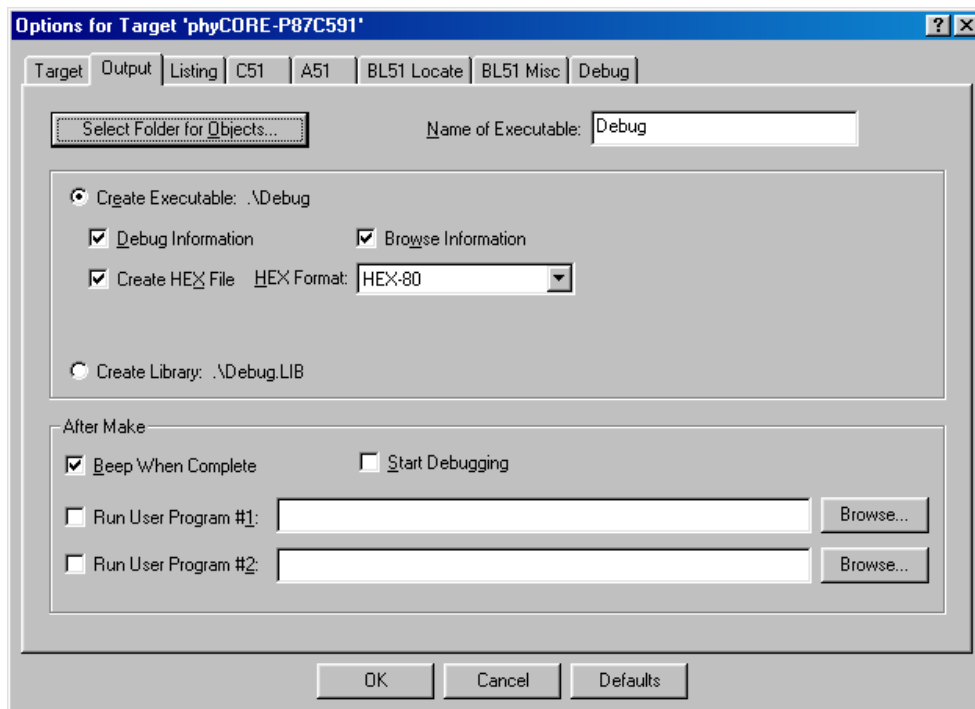

- Go to the **C51** tabsheet and erase all defines from the *Define:* input field and adjust the optimization to your needs.

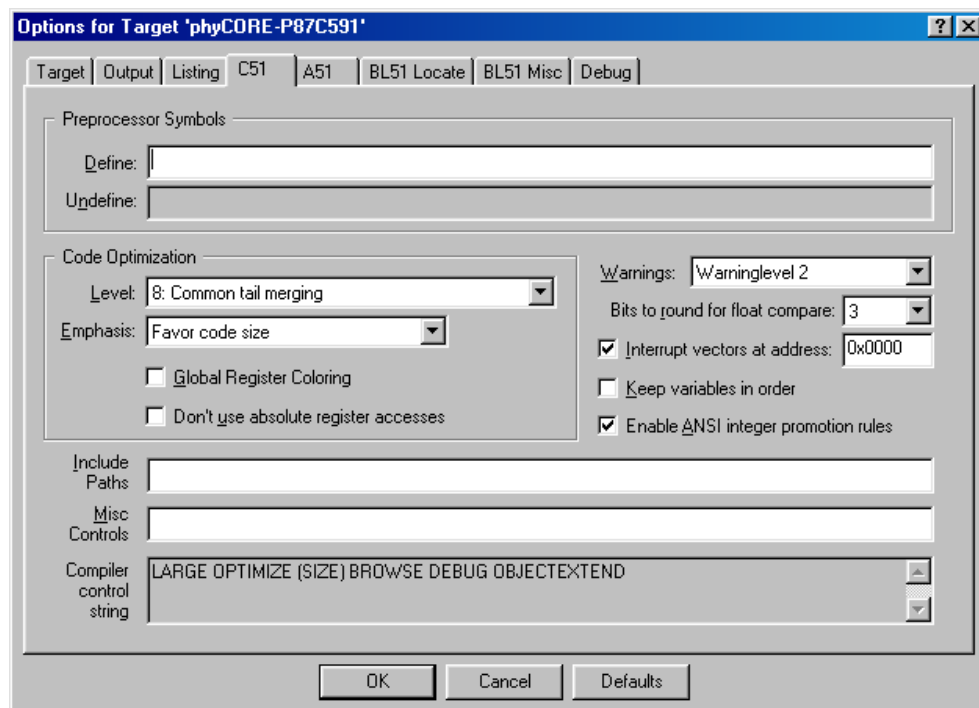

- Click on the *OK* button to save the settings.
- Click on the *Rebuild all target files*  icon to compile and link your project.
- Download the created **Debug.hex** file (located in *C:\PHYBasic\pC-P87C591\Demos\Keil\Debug*) to the Flash memory. For general download procedure information refer to sections 2.2 through 2.4.
- Press the Reset button S2 on the Development Board to start the program.
- The application is now waiting for receipt of a known character over the serial interface. Start the HyperTerminal program and push the <Space> bar as described in section 2.4.2. This starts the automatic baud rate detection. Now you can watch your final debug example execute.

5 Advanced User Information

This section provide advanced information for successful operation of the phyCORE-P87C591 in conjunction with the Keil tool chain.

5.1 FlashTools98

Flash is a highly functional means of storing nonvolatile-data. One of its advantages among many others is the possibility of on-board programming. Programming tools for the Flash device are always included with the phyCORE-P87C591 in the form of a pre-programmed Flash with a resident microcontroller firmware and a counterpart software serving as the user interface on a host-PC. Once the firmware communicates with the PC-based software, FlashTools98 allows the download of user code from the host-PC into the Flash. Additionally, the re-programmable Flash device on the phyCORE-P87C591 allows you to easily update your own code and the target application in which the phyCORE-P87C591 has been implemented.

Currently the phyCORE-P87C591 can be populated by two different sized Flash devices: a 29F010 with 128 kByte or a 29F040 with 512 kByte. To support the entire memory area of these devices the address decoder of the phyCORE-P87C591 is equipped with an integrated banking mechanism that allows code-bank switching in code-banks of 64 kByte each.

Please note that the FlashTools98 kernel always occupies the first 64 kByte bank (bank 0, FA[18..15] = 0000b) of the Flash memory. This bank is pre-programmed upon delivery of the phyCORE-P87C591. The remaining banks are available to house your application. This makes one user application bank available if the phyCORE-P87C591 is mounted with a 29F010 and seven user application banks if the phyCORE-P87C591 is mounted with a 29F040 Flash memory device. Multiple user application banks can easily be managed by using the Code Banking mechanism of the Keil tool chain.

The following description is valid only for the FlashTools98 included with the phyCORE-P87C591 and is not intended as a guideline for using any other program.

FlashTools98 incorporates a safety mechanism that ensures that the system bank (bank 0), in which the firmware is resident, can not be overwritten during programming of the available user banks of the Flash device.

Resetting the phyCORE-P87C591 also activates the system bank (bank 0) of the Flash device, which automatically starts the FlashTools98 firmware. Then the firmware either enters the Flash programming mode or starts your user application.

To distinguish between download and execution modes, the firmware latches the /BOOT signal after reset (/BOOT=0 => start Flashtools, /BOOT=1 => start user program). This signal can be set to a low level by pressing the Boot (S1) button located on the phyCORE Development Board LD 5V. To enter the Flash programming mode you must simultaneously press the Reset (S2) and the Boot (S1) button, release the Reset (S2) button first and then, two to three seconds later, release the Boot (S1) button.

Execution of your user application will always start in the second 64 kByte bank (bank 1, FA[18..15] = 0010b). This is to be noted when preparing a software copy of the contents of the address decoder's internal write-only registers.

The extended features of the address decoder on the phyCORE-P87C591 allows flexibility when configuring the memory model according to your needs and addressing additional Flash banks.

Do not use Flash bank 0 in your application program in order to preserve the FlashTools98 microcontroller firmware and the associated Flash re-programming capability.

5.2 STARTUP.A51

The code within the assembly file *Startup.a51* initializes the target hardware for your C project. This includes setting of the system stack, initialization of variables and clearing of memory areas.

The *Startup.a51* routines always start at code memory address 0x0000. This is where the reset vector with the jump instruction to the actual *Startup.a51* initialization functions is located. Following a hardware or software reset, the microcontroller starts execution at address 0x0000 and then jumps to the start-up routines location configured by the reset vector. After performing the initialization steps, your individual *main()* function is called by the startup code.

To configure the start-up code to fit the needs of your application, copy it from the *Lib* folder of the Keil tool chain to your project folder. You can then edit, modify and compile it using the Keil macroassembler.

You must explicitly instruct the linker to take into account your start-up object file. If not, the start-up code in the default runtime libraries will be used. To do this, we recommend adding your modified *Startup.a51* file to your project. Ensure that this file is always included in the Link/Lib process of your project (see options within the *Project* window of the Keil tool chain).

We recommend that you add *Startup.a51* or *Startup.obj* (depending on the kind of file you want to add to the project) within the project tree.

5.3 Linking and Locating

The Linker must combine several relocatable object modules contained in object files and/or libraries to generate a single absolute object.

In addition, the linker must locate several segments of code and data to fixed address locations within the address space in regards to the memory types of the phyCORE-P87C591. XDATA segments always must be located to Random Access Memory (e.g. RAM), CODE segments should be located to non-volatile memory (e.g. Flash). The 8051 family supports a Harvard memory architecture that distinguishes between non-volatile and randomly accessible memory and has two physically different signals for separate fetching of data and code.

The Keil tool chain distinguishes the following segment types:

- **CODE:** code
- **XDATA:** external data (max. 64 kByte)
- **DATA:** direct addressable on-chip data (max. 128 Byte)
- **IDATA:** indirect addressable on-chip data (max. 256 Byte)
- **BIT:** bit-addressable on-chip data (max. 128-bits)

The segment types DATA, IDATA and BIT always reside in the on-chip RAM of the controller.

The segment types XDATA and CODE will usually reside in external memory devices.

To ensure proper execution of your application, it is required that all XDATA segments are located to the external RAM of the phyCORE-P87C591 and that all CODE segments are located to the external Flash memory of the phyCORE-P87C591. Exceptions may occur if you use a 8051 derivative with on-chip portions of XDATA (e.g. internal XRAM) or CODE (e.g. internal ROM).

Since the phyCORE-P87C591 is equipped with a software configurable address decoder instead of simple programmable logic device, you can configure the memory model to your needs at runtime.

To ensure proper execution of your application, you must take the runtime memory model into consideration when linking and locating. This means that you must instruct the linker where to assume external RAM for locating data segments and Flash for locating code segments.

The standard configuration of the phyCORE-P87C591 is equipped with 128 kByte of external RAM and 128 kByte of external Flash. During runtime the RAM will be addressable at 0x0000 to 0xFFFF. The user bank (bank 1, FA[18..15] = 0010b) will be addressable at 0x0000 to 0xFFFF. This default runtime memory model requires no additional linker settings because both RAM and Flash start at 0x0000. This is also the default start address of the linker's segment types.

Since you can not define any end address, you should always ensure that the size of the segments fits within the available size of the mounted memory devices. For instance all XDATA segments should end below 0x7FFF if a 32 kByte RAM device is mounted on the phyCORE-P87C591. We recommend generation of a **.m51* map file for your project and inspection of the memory map information within this file.

Whenever you modify the memory model (e.g. use von Neumann rather than Harvard memory), which leads to different start addresses of CODE or XDATA memory, you must configure this in the linker settings.

When using the full version of the Keil tool chain, the start address of the CODE memory should be at 0x100. This avoids conflicts with the interrupt/reset vector table which is located between 0x0000 and 0x00FF.

Document: phyCORE-P87C591 QuickStart Instructions
Document number: L-471e_5, July 2002

How would you improve this manual?

Did you find any mistakes in this manual? _____ page

Submitted by:

Customer number: _____

Name: _____

Company: _____

Address: _____

Return to:

PHYTEC Technologie Holding AG
Postfach 100403
D-55135 Mainz, Germany
Fax : +49 (6131) 9221-33

Published by

PHYTEC

© PHYTEC Meßtechnik GmbH 2002

Ordering No. L-471e_5
Printed in Germany