

phyCORE-LPC3250

System on Module and Carrier Board

Hardware Manual

Document No: L-714e_1
Product No: PCM-040
SOM PCB No: 1304.1
CB PCB No: 1305.2, 1305.3
Edition: January 27, 2009

Table of Contents

| | |
|--|-------------|
| List of Tables | .iii |
| List of Figures | v |
| Conventions, Abbreviations and Acronyms | .vi |
| Preface | viii |
| Part I: PCM-040/phyCORE-LPC3250 System on Module | 1 |
| 1 Introduction | 2 |
| 1.1 Block Diagram | 4 |
| 1.2 View of the phyCORE-LPC3250 | 5 |
| 2 Pin Description | 7 |
| 3 Jumpers | 19 |
| 4 Power | 24 |
| 4.1 Primary System Power (VCC) | 24 |
| 4.2 Secondary Battery Power (VBAT) | 24 |
| 4.3 Analog-to-Digital Converter Power (VCC_AD_EXT) | 24 |
| 4.4 SDIO Controller Power (VCC_SDIO) | 25 |
| 4.5 On-board Voltage Regulators | 25 |
| 4.5.1 Primary 1.2V and 1.8V Supplies (U23) | 26 |
| 4.5.2 Adjustable Core Voltage Supply (U27) | 27 |
| 4.5.3 SDRAM and RTC Supplies (U22) | 27 |
| 4.5.4 Selecting Shunt Resistors for Current Measurements | 27 |
| 4.6 Voltage Supervisor (U16, U17) | 28 |
| 5 Deep Sleep | 30 |
| 6 External RTC (U26) | 32 |
| 7 External Watchdog | 33 |
| 8 System Configuration and Booting | 34 |
| 8.1 Boot Process and Boot Modes | 34 |
| 8.1 Stage 1 Loader | 37 |
| 9 System Memory | 39 |
| 9.1 SDRAM (U10, U11) | 39 |
| 9.2 NAND Flash (U8) | 39 |
| 9.3 NOR Flash (U12, U13) | 40 |
| 9.4 NOR vs. NAND | 40 |
| 9.5 EEPROM (U9) | 40 |
| 9.6 Memory Map | 42 |
| 10 Serial Interfaces | 43 |
| 10.1 RS-232 Transceiver (U25) | 43 |
| 10.2 Ethernet PHY (U6) | 43 |
| 10.2.1 Configuring the PHY Operating Mode (J7, J8, J9) | 44 |
| 10.3 USB OTG Transceiver (U24) | 45 |
| 11 SDIO Controller (U14) | 47 |
| 12 Debug Interface (X1) | 49 |
| 13 Bus Buffers (U1, U2, U3, U4, U5) | 50 |
| 13.1 Buffered Memory Bus Voltage Select (J21) | 51 |
| 14 Technical Specifications | 52 |
| 15 Hints for Handling the phyCORE-LPC3250 | 54 |
| 16 Component Placement Diagrams | 55 |

| | |
|---|------------|
| Part II: PCM-967/phyCORE-LPC3250 Carrier Board | 57 |
| 17 Introduction | 58 |
| 18 Overview of Peripherals | 59 |
| 19 Jumpers | 61 |
| 20 phyCORE-LPC3250 SOM Connectivity | 65 |
| 21 Power | 66 |
| 21.1 Wall Adapter Input | 68 |
| 21.2 Power over Ethernet (PoE) | 69 |
| 21.3 Lithium-Ion Battery | 69 |
| 21.3.1 Battery Charging Circuit | 70 |
| 21.4 3.15V Supply (U9) | 70 |
| 21.5 1.8V Supply (U10) | 71 |
| 21.6 5.0V Buck-Boost Supply (U21) | 71 |
| 21.7 Power Path Controller | 71 |
| 21.8 Current Measurement | 71 |
| 22 JTAG Connectivity | 72 |
| 23 Deep Sleep Circuit | 75 |
| 23.1 3.0V Deep Sleep Supply (U11) | 79 |
| 24 Audio Interface | 80 |
| 25 Ethernet Connectivity | 82 |
| 26 USB Connectivity | 84 |
| 27 LCD Connectivity | 86 |
| 28 GPIO Expansion Connector | 91 |
| 29 RS-232 Connectivity | 92 |
| 30 SD/MMC Connectivity | 97 |
| 31 SDIO Connectivity | 99 |
| 32 Keyboard Connectivity | 102 |
| 33 User Buttons | 105 |
| 34 User LEDs | 107 |
| 35 User ADC Potentiometer | 109 |
| 36 Boot Mode Selection | 110 |
| 37 System Reset Button | 111 |
| 38 Watchdog Circuit | 112 |
| | |
| Part III: PCM-988/GPIO Expansion Board | 113 |
| 39 Introduction | 114 |
| 40 System Signal Mapping | 116 |
| 41 Memory Bus Signal Mapping | 117 |
| 42 LCD Signal Mapping | 119 |
| 43 UART Signal Mapping | 120 |
| 44 I ² C Signal Mapping | 121 |
| 45 GPIO Signal Mapping | 122 |
| 46 USB Signal Mapping | 123 |
| 47 SSP Signal Mapping | 124 |
| 48 I ² S Signal Mapping | 125 |
| 49 Power Signal Mapping | 126 |
| | |
| Revision History | 127 |
| | |
| Index | 128 |

List of Tables

| | |
|--|------------|
| Conventions, Abbreviations and Acronyms | vi |
| Table 1-1. Abbreviations and Acronyms used in this Manual. | vi |
| Part I: PCM-040/phyCORE-LPC3250 System on Module | 1 |
| Table 2-1. Pin Descriptions, phyCORE-Connector X2, Row A | 8 |
| Table 2-2. Pin Descriptions, phyCORE-Connector X2, Row B | 10 |
| Table 2-3. Pin Descriptions, phyCORE-Connector X2, Row C | 12 |
| Table 2-4. Pin Descriptions, phyCORE-Connector X2, Row D | 15 |
| Table 3-1. Jumper Settings | 20 |
| Table 4-1. U23 1.2V/1.8V Primary Voltage Regulator Jumper Settings | 26 |
| Table 4-2. U22 RTC/SDRAM Voltage Regulator Jumper Settings | 27 |
| Table 4-3. Primary System Supervisor Reset Thresholds | 28 |
| Table 4-4. Sleep System Supervisor Reset Thresholds | 28 |
| Table 9-1. Valid SDRAM Memory Address Ranges | 39 |
| Table 9-2. NAND Flash Write Protection via Jumper J5 | 39 |
| Table 9-3. Valid NOR Flash Memory Address Ranges | 40 |
| Table 9-4. EEPROM Configuration Struct <i>dramcfg</i> Field Format | 41 |
| Table 9-5. EEPROM Configuration Struct <i>syscfg</i> Field Format | 41 |
| Table 9-6. phyCORE-LPC3250 Memory Map | 42 |
| Table 10-1. UART 1/UART 5 TTL and RS-232 Level Signals | 43 |
| Table 10-2. Ethernet PHY Operating Mode Selection | 45 |
| Table 10-3. Applicable USB Operating Mode Connectors | 46 |
| Table 11-1. SDIO Controller to LPC3250 Signal Mapping | 47 |
| Table 11-2. SDIO Controller Interface Signals | 48 |
| Table 13-1. Buffered Memory Bus Signal Mapping | 50 |
| Table 13-2. Buffered Memory Bus Map | 50 |
| Table 14-1. Technical Specifications | 52 |
| Table 14-2. Static Operating Characteristics | 53 |
| Part II: PCM-967/phyCORE-LPC3250 Carrier Board | 57 |
| Table 18-1. Connectors and Headers | 59 |
| Table 18-2. Description of the Buttons and Switches | 60 |
| Table 18-3. Description of LEDs | 60 |
| Table 18-4. Description of Potentiometers | 60 |
| Table 19-1. Jumper Settings | 62 |
| Table 21-1. Possible Ethernet PSE Options | 69 |
| Table 22-1. LPC3250 JTAG Connector X12 Pin Descriptions | 72 |
| Table 22-2. Compatible JTAG Probes for the phyCORE-LPC3250 Carrier Board | 73 |
| Table 27-1. LPC3250 LCD Port to Buffered CPLD Signal Mapping | 89 |
| Table 27-2. LCD Mode Jumper Summary (JP48, JP49, JP50) | 90 |
| Table 29-1. Connector P1A (UART5) Pin Descriptions | 93 |
| Table 29-2. Connector P1B (UART3 and UART2) Pin Descriptions | 93 |
| Table 29-3. UART3/UART2 Header Connector X13 Pin Descriptions | 94 |
| Table 29-4. Configuring DB-9 Connector P1B for UART3 or UART2 Operation | 95 |
| Table 31-1. SDIO Easy Access Header Connector X23 Signal Descriptions | 100 |
| Table 32-1. Dip Switch S5 Positions and Associated Signals | 103 |
| Table 32-2. Dip Switch S6 Positions and Associated Signals | 103 |
| Table 32-3. Ethernet/Keyboard Easy Access Header Connector X11 Signal Descriptions | 103 |
| Part III: PCM-988/GPIO Expansion Board | 113 |
| Table 39-1. Signals Removed from the GPIO Expansion Connector | 115 |

| | |
|---|------------|
| Table 40-1. System Signal Mapping | 116 |
| Table 41-1. Memory Bus Signal Mapping | 117 |
| Table 42-1. LCD Signal Mapping | 119 |
| Table 43-1. UART Signal Mapping | 120 |
| Table 44-1. I ² C Signal Mapping | 121 |
| Table 45-1. GPIO Signal Mapping | 122 |
| Table 46-1. USB Signal Mapping | 123 |
| Table 47-1. SSP Signal Mapping | 124 |
| Table 48-1. I ² S Signal Mapping | 125 |
| Table 49-1. Power Signal Mapping | 126 |
| Revision History | 127 |
| Table 50-1. Revision History | 127 |

List of Figures

| | |
|--|------------|
| Part I: PCM-040/phyCORE-LPC3250 System on Module | 1 |
| Fig. 1-1. phyCORE-LPC3250 Block Diagram. | 4 |
| Fig. 1-2. Top View of the phyCORE-LPC3250 (Controller Side) | 5 |
| Fig. 1-3. Bottom View of the phyCORE-LPC3250 (Connector Side) | 6 |
| Fig. 2-1. Pin-out of the phyCORE-Connector (Top View, with Cross Section Insert) | 8 |
| Fig. 3-1. Jumper Locations (Controller Side) | 19 |
| Fig. 3-2. Jumper Locations (Connector Side) | 20 |
| Fig. 3-3. Default Jumper Settings (Controller Side) | 22 |
| Fig. 3-4. Default Jumper Settings (Connector Side) | 23 |
| Fig. 4-1. phyCORE-LPC3250 On-board Powering Scheme. | 26 |
| Fig. 5-1. Typical phyCORE-LPC3250 Sleep Enabled Powering Scheme | 30 |
| Fig. 8-1. Small Page SLC NAND Flash Structure | 36 |
| Fig. 10-1. Ethernet PHY Disconnection Resistors | 44 |
| Fig. 12-1. JTAG Interface X1 (Controller Side) | 49 |
| Fig. 14-1. phyCORE-LPC3250 Physical Dimensions. | 52 |
| Fig. 16-1. phyCORE-LPC3250 Component Placement (Controller Side) | 55 |
| Fig. 16-2. phyCORE-LPC3250 Component Placement (Connector Side) | 56 |
| | |
| Part II: PCM-967/phyCORE-LPC3250 Carrier Board | 57 |
| Fig. 17-1. phyCORE-LPC3250 Carrier Board Overview of Connectors and Interfaces | 58 |
| Fig. 19-1. Jumper Locations and Default Settings | 61 |
| Fig. 19-2. Typical Jumper Pad Numbering Scheme (Removable Jumpers) | 62 |
| Fig. 20-1. phyCORE-LPC3250 SOM Connectivity to the Carrier Board. | 65 |
| Fig. 21-1. Powering Scheme | 66 |
| Fig. 21-2. Powering Scheme Block Diagram | 68 |
| Fig. 22-1. JTAG Probe Connectivity to the LPC3250 | 72 |
| Fig. 23-1. Deep Sleep Jumpers and Power Button | 75 |
| Fig. 23-2. Deep Sleep Circuit Block Diagram | 76 |
| Fig. 23-3. Deep Sleep State Diagram. | 78 |
| Fig. 24-1. Audio Interface Connectors and Jumpers | 80 |
| Fig. 25-1. Ethernet Interface Connectors and Jumpers | 82 |
| Fig. 26-1. USB Interface Connectors and Jumpers | 84 |
| Fig. 27-1. LCD Interface Connectors and Jumpers | 86 |
| Fig. 27-2. LCD BLUE Signal Mapping in 24-bit Mode with a 24-Bit LCD | 87 |
| Fig. 27-3. LCD BLUE Signal Mapping in 16-bit Mode with an 18-Bit LCD | 87 |
| Fig. 28-1. GPIO Expansion Connector | 91 |
| Fig. 29-1. RS-232 Interface Connectors and Jumpers | 92 |
| Fig. 29-2. DB-9 RS-232 Connectors P1A and P1B Pin Numbering | 93 |
| Fig. 29-3. UART3/UART2 Header Connector X13 Pin Numbering | 94 |
| Fig. 30-1. SD/MMC Interface Connectors and Jumpers. | 97 |
| Fig. 31-1. SDIO Interface Connectors and Jumpers | 99 |
| Fig. 32-1. Keyboard Interface Connector and Dip Switches. | 102 |
| Fig. 33-1. User Buttons and Jumpers. | 105 |
| Fig. 34-1. User LEDs and Jumpers | 107 |
| Fig. 35-1. User ADC Potentiometer and Jumper | 109 |
| Fig. 36-1. Boot Mode Selection Jumper | 110 |
| Fig. 37-1. System Reset Button | 111 |
| Fig. 38-1. Watchdog Enable Jumper | 112 |
| | |
| Part III: PCM-988/GPIO Expansion Board | 113 |
| Fig. 39-1. PCM-988/GPIO Expansion Board and Patch Field | 114 |

Conventions, Abbreviations and Acronyms

Conventions

The conventions used in this manual are as follows:

- Signals that are preceded by a “/” character are designated as active low signals. That is, their active state is when they are driven low, or are driving low; e.g., /RESET.
- Tables which describe jumper settings show the default position in **bold, teal text**.
- Text in [blue](#) indicates a hyperlink within, or external to the document. Click these links to quickly jump to the applicable URL, part, chapter, table, or figure.
- References made to the *phyCORE-Connector* always refer to the high density molex connectors on the underside of the phyCORE-LPC3250 System on Module.

Abbreviations and Acronyms

Many acronyms and abbreviations are used throughout this manual. Use the table below to navigate unfamiliar terms used in this document.

Table 1-1. Abbreviations and Acronyms used in this Manual

| Abbreviation | Definition |
|--------------|--|
| GPIO | General purpose input and output. |
| GPI | General purpose input. |
| GPO | General purpose output. |
| BTN1 | User button 1; used in reference to one of the two available user buttons on the Carrier Board. |
| BTN2 | User button 2; used in reference to one of the two available user buttons on the Carrier Board. |
| CB | Carrier Board; used in reference to the PCM-967/phyCORE-LPC3250 Carrier Board. |
| DFF | D flip-flop. |
| EMB | External memory bus. |
| EMI | Electromagnetic Interference. |
| GPIOEBPF | GPIO Expansion Board Patch Field; used in reference with the PCM-988/GPIO Expansion Board and its associated patch field. |
| IRAM | Internal RAM; the internal static RAM on the LPC3250 processor. |
| J | Solder jumper; these types of jumpers require solder equipment to remove and place. |
| JP | Solderless jumper; these types of jumpers can be removed and placed by hand with no special tools. |
| KS | Kickstart; the second level bootloader flashed on the phyCORE-LPC3250 SOM. |
| PCB | Printed circuit board. |
| PoE | Power-over-Ethernet. |
| POT | Potentiometer. |
| PSE | Power sourcing equipment; the device in a PoE network that provides power to connected devices--usually a switch, router, or stand alone power injector. |
| RTC | Real-time clock. |
| S1L | Stage 1 Loader; the third level bootloader flashed on the phyCORE-LPC3250 SOM. |
| SMT | Surface mount technology. |

Table 1-1. Abbreviations and Acronyms used in this Manual (Continued)

| Abbreviation | Definition |
|---------------------|--|
| SOM | System on Module; used in reference to the PCM-040/phyCORE-LPC3250 System on Module. |
| VBAT | SOM battery supply input |
| VFP | Vector floating point. |

Preface

This phyCORE-ARM9/LPC3250 Hardware Manual describes the single board computer's design and functions. Precise specifications for the NXP Semiconductors LPC3250 processor can be found in the enclosed processor Data Sheet/User's Manual. If software is included please also refer to additional documentation for this software.

In this hardware manual and in the attached schematics, low active signals are denoted by a "/" preceding the signal name (i.e.: /RD). A "0" indicates a logic-zero or low-level signal, while a "1" represents a logic-one or high-level signal.

Declaration of Electro Magnetic Conformity of the PHYTEC phyCORE-LPC3250



PHYTEC System on Modules (SOMs) are designed for installation in electrical appliances or, combined with the PHYTEC Carrier Board, can be used as dedicated Evaluation Boards (i.e.: for use as a test and prototype platform for hardware/software development) in laboratory environments.

CAUTION:

PHYTEC products lacking protective enclosures are subject to damage by ESD and, hence, may only be unpacked, handled or operated in environments in which sufficient precautionary measures have been taken in respect to ESD-dangers. It is also necessary that only appropriately trained personnel (such as electricians, technicians and engineers) handle and/or operate these products. Moreover, PHYTEC products should not be operated without protection circuitry if connections to the product's pin header rows are longer than 3 m.

PHYTEC products fulfill the norms of the European Union's Directive for Electro Magnetic Conformity only in accordance to the descriptions and rules of usage indicated in this hardware manual (particularly in respect to the pin header row connectors, power connector and serial interface to a host-PC).

Implementation of PHYTEC products into target devices, as well as user modifications and extensions of PHYTEC products, is subject to renewed establishment of conformity to, and certification of, Electro Magnetic Directives. Users should ensure conformance following any modifications to the products as well as implementation of the products into target systems.

The phyCORE-LPC3250 is one of a series of PHYTEC System on Modules that can be populated with different controllers and, hence, offers various functions and configurations. PHYTEC supports a variety of 8-/16- and 32-bit controllers in two ways:

1. As the basis for Rapid Development Kits which serve as a reference and evaluation platform.
2. As insert-ready, fully functional phyCORE OEM modules, which can be embedded directly into the user's peripheral hardware, design.

Implementation of an OEM-able SOM subassembly as the "core" of your embedded design allows you to focus on hardware peripherals and firmware without expending resources to "re-invent" microcontroller circuitry. Furthermore, much of the value of the phyCORE module lies in its layout and test.

Production-ready Board Support Packages (BSPs) and Design Services for our hardware further reduce development time and expenses. Take advantage of PHYTEC products to shorten time-to-market, reduce development costs, and avoid substantial design issues and risks. For more information go to:

<http://www.phytec.com/services/phytec-advantage.html>

Part I: PCM-040/phyCORE-LPC3250 System on Module

Part 1 of this 3 part manual provides detailed information on the phyCORE-ARM9/LPC3250 System on Module (SOM) designed for custom integration into customer applications.

The information in the following chapters is applicable to the 1304.1 PCB revision of the phyCORE-LPC3250 SOM.

1 Introduction

The phyCORE-LPC3250 belongs to PHYTEC's phyCORE System on Module (SOM) family. The phyCORE SOMs represent the continuous development of PHYTEC SOM technology. Like its mini-, micro- and nanoMODUL predecessors, the phyCORE boards integrate all core elements of a microcontroller system on a subminiature board and are designed in a manner that ensures their easy expansion and embedding in peripheral hardware developments.

As independent research indicates that approximately 70% of all EMI (Electro Magnetic Interference) problems stem from insufficient supply voltage grounding of electronic components in high frequency environments, the phyCORE board design features an increased pin package. The increased pin package allows dedication of approximately 20% of all connector pins on the phyCORE boards to ground. This improves EMI and EMC characteristics and makes it easier to design complex applications meeting EMI and EMC guidelines using phyCORE boards even in high noise environments.

phyCORE boards achieve their small size through modern SMD technology and multi-layer design. In accordance with the complexity of the module, 0402-packaged SMD components and laser-drilled Microvias are used on the boards, providing phyCORE users with access to this cutting edge miniaturization technology for integration into their own design.

The phyCORE-LPC3250 is a sub-miniature (70 x 58 mm) insert-ready SOM populated with the NXP LPC3250 ARM926EJ-S core processor. Its universal design enables its insertion in a wide range of embedded applications. All processor signals and ports extend from the processor to high-density pitch (0.635 mm) connectors aligning two sides of the board, allowing it to be plugged like a "big chip" into a target application.

Precise specifications for the processor populating the board can be found in the applicable processor User's Manual or datasheet. The descriptions in this manual are based on the NXP Semiconductors ARM9/LPC3250 processor. No description of compatible processor derivative functions is included, as such functions are not relevant for the basic functioning of the phyCORE-LPC3250.

The phyCORE-LPC3250 offers the following features:

- Insert-ready, sub-miniature (70 x 58 mm) System on Module (SOM) subassembly in low EMI design, achieved through advanced SMD technology
- Populated with the NXP LPC3250 processor (296-ball BGA packaging)
- Improved interference safety achieved through multi-layer PCB technology and dedicated ground pins
- Controller signals and ports extend to two 160-pin high-density (0.635 mm) Molex connectors aligning two sides of the board, enabling it to be plugged like a "big chip" into target application
- Max. 208 MHz core clock frequency
- Vector Floating Point coprocessor supporting single-precision and double-precision add, subtract, multiply, divide, and multiply-accumulate at CPU clock speeds.
- Memory Management Unit (MMU), Memory and DMA controllers
- 64 MB of external address space, with bus buffers to condition and protect signal load of peripherals on the LPC3250 external memory bus
- 1 to 8 MB of on-board NOR Flash operating at 1.8V or 3.15V
- 16 to 128 MB of on-board NAND flash at 1.8V
- 16 to 128MB of on-board 1.8V mobile SDRAM at 104 MHz
- 32 KByte SPI bootable EEPROM
- USB OTG transceiver for embedded USB host/peripheral functionality
- 6 rail voltage supervision with deep sleep supervision support
- On-board high efficiency switching regulators generating 1.8, 1.2, and an adjustable 0.9-1.2 voltage supplies
- Processor independent watchdog with disable, normal, and extended modes

- Support for ETM9 and Embedded ICE-RT debug through JTAG interface
- Keyboard support for up to 64 keys in an 8 x 8 matrix (Ethernet must be disabled to support this feature)
- 2x SPI ports
- 2x SSP ports
- 7x UARTs – 3 high speed (920kbps), 4 standard speed (460kbps), 1 supporting IrDA with 2x at RS-232 levels
- 2x I²S ports
- 2x I²C ports
- 10/100 Ethernet with HP Auto MDIX support
- 24-bit LCD controller supporting STN and TFT panels at up to 1024x768 display resolution
- Integrated LCD touch screen controller
- SD/MMC card interface
- SDIO controller
- Internal controller based RTC with 32 byte scratch pad memory
- External processor independent ultra low power RTC consuming 275nA @ 3.0V typical
- 32-bit high speed timer
- 4x timer/counters with capture inputs and match outputs
- 32-bit millisecond timer driven from the RTC clock
- Processor based watchdog timer
- 12x PWM outputs
- JTAG interface for debugging and download of user code
- Single supply voltage of 3.15V with on-board power management
- Industrial temperature range (-40°...+85°)

1.1 Block Diagram

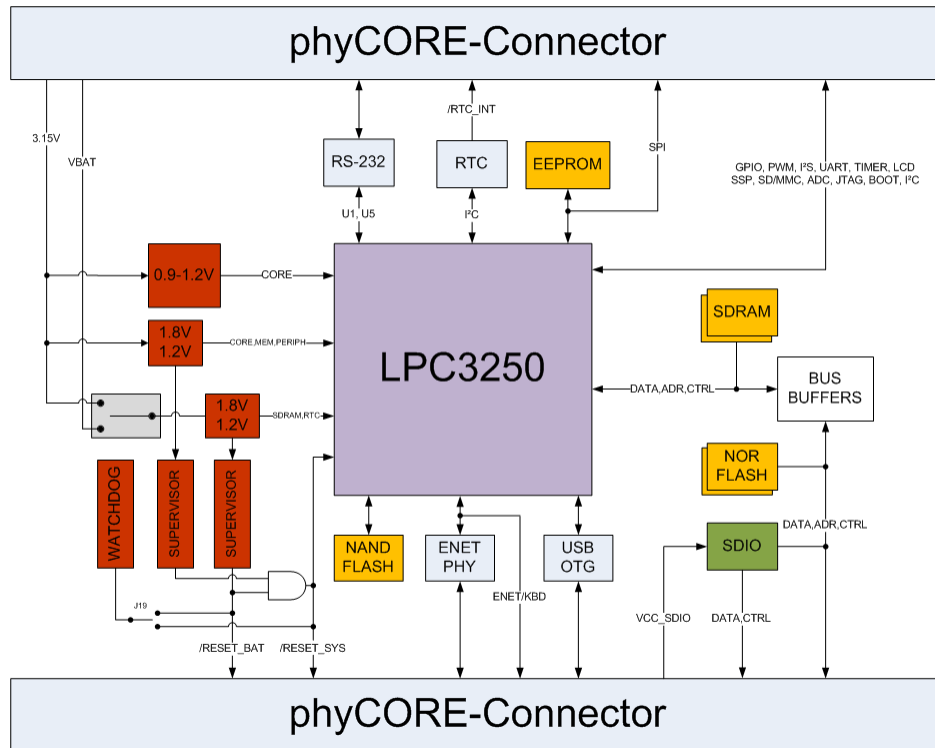

Fig. 1-1. phyCORE-LPC3250 Block Diagram

1.2 View of the phyCORE-LPC3250

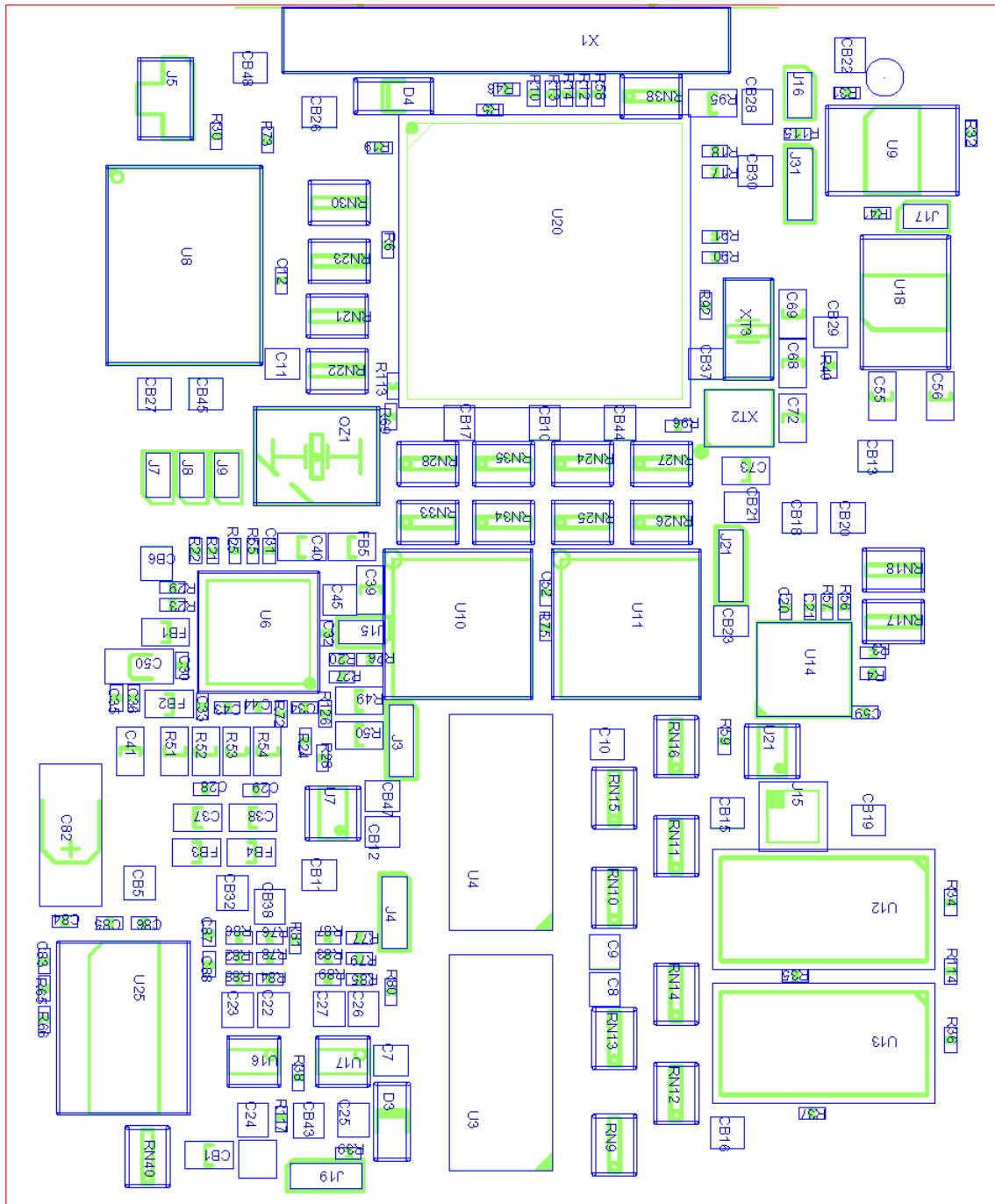

Fig. 1-2. Top View of the phyCORE-LPC3250 (Controller Side)

2 Pin Description

Please note that all module connections are not to exceed their expressed maximum voltage or current. Maximum signal input values are indicated in the corresponding controller manuals/data sheets. As damage from improper connections varies according to use and application, it is the user's responsibility to take appropriate safety measures to ensure that the module connections are protected from overloading through connected peripherals.

All controller signals extend to surface mount technology (SMT) connectors (0.635 mm) lining two sides of the module (referred to as the phyCORE-Connector). This allows the phyCORE-LPC3250 to be plugged into any target application like a "big chip".

The numbering scheme for the phyCORE-Connector is based on a two dimensional matrix in which column positions are identified by a letter and row position by a number. Pin 1A, for example, is always located in the upper left hand corner of the matrix. The pin numbering values increase moving down on the board. Lettering of the pin connector rows progresses alphabetically from left to right (refer to [Figure 2-1](#)).

The numbered matrix can be aligned with the phyCORE-LPC3250 (viewed from above; phyCORE-Connector pointing down) or with the socket of the corresponding phyCORE Carrier Board/user target circuitry. The upper left-hand corner of the numbered matrix (pin 1A) is thus covered with the corner of the phyCORE-LPC3250 marked with a white triangle. The numbering scheme is always in relation to the PCB as viewed from above, even if all connector contacts extend to the bottom of the module.

The numbering scheme is thus consistent for both the module's phyCORE-Connector as well as mating connectors on the phyCORE Carrier Board or target hardware, thereby considerably reducing the risk of pin identification errors.

Since the pins are exactly defined according to the numbered matrix previously described, the phyCORE-Connector is usually assigned a single designator for its position (X1 for example). In this manner the phyCORE-Connector comprises a single, logical unit regardless of the fact that it could consist of more than one physical socketed connector. The location of row 1 on the board is marked by a white triangle on the PCB to allow easy identification.

[Figure 2-1](#) illustrates the numbered matrix system. It shows a phyCORE-LPC3250 with SMT phyCORE-Connectors on its underside (defined as dotted lines) mounted on a Carrier Board. In order to facilitate understanding of the pin assignment scheme, the diagram presents a cross-view of the phyCORE module showing these phyCORE-Connectors mounted on the underside of the module's PCB.

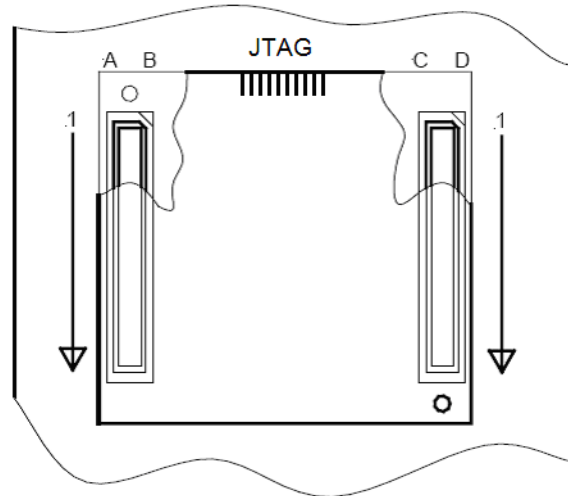

Fig. 2-1. Pin-out of the phyCORE-Connector (Top View, with Cross Section Insert)

Table 2-1. Pin Descriptions, phyCORE-Connector X2, Row A

| Pin # | Signal | I/O | SL | Description |
|-------|--------|-----|---------|--|
| 1A | N/C | - | - | Not connected |
| 2A | GND | - | - | Ground |
| 3A | N/C | - | - | Not connected |
| 4A | N/C | - | - | Not connected |
| 5A | b_/CS0 | O | VCC_EMB | Buffered μ C signal /CS0 (memory bus chip select 0) |
| 6A | b_/CS1 | O | VCC_EMB | Buffered μ C signal /CS1 (memory bus chip select 1) |
| 7A | GND | - | - | Ground |
| 8A | b_/WR | O | VCC_EMB | Buffered μ C signal /WR (memory bus write enable) |
| 9A | b_A1 | O | VCC_EMB | Buffered μ C signal A1 (memory bus address bit A1) |
| 10A | b_A2 | O | VCC_EMB | Buffered μ C signal A2 (memory bus address bit A2) |
| 11A | b_A4 | O | VCC_EMB | Buffered μ C signal A4 (memory bus address bit A4) |
| 12A | GND | - | - | Ground |
| 13A | b_A7 | O | VCC_EMB | Buffered μ C signal A7 (memory bus address bit A7) |
| 14A | b_A9 | O | VCC_EMB | Buffered μ C signal A9 (memory bus address bit A9) |
| 15A | b_A10 | O | VCC_EMB | Buffered μ C signal A10 (memory bus address bit A10) |
| 16A | b_A12 | O | VCC_EMB | Buffered μ C signal A12 (memory bus address bit A12) |
| 17A | GND | - | - | Ground |
| 18A | b_A15 | O | VCC_EMB | Buffered μ C signal A15 (memory bus address bit A15) |
| 19A | b_D1 | I/O | VCC_EMB | Buffered μ C signal D1 (memory bus data bit D1) |
| 20A | b_D2 | I/O | VCC_EMB | Buffered μ C signal D2 (memory bus data bit D2) |
| 21A | b_D4 | I/O | VCC_EMB | Buffered μ C signal D4 (memory bus data bit D4) |
| 22A | GND | - | - | Ground |
| 23A | b_D7 | I/O | VCC_EMB | Buffered μ C signal D7 (memory bus data bit D7) |

Table 2-1. Pin Descriptions, phyCORE-Connector X2, Row A (Continued)

| Pin # | Signal | I/O | SL | Description |
|-------|--------|-----|---------|--|
| 24A | b_A17 | O | VCC_EMB | Buffered μ C signal A17 (memory bus address bit A17) |
| 25A | b_A18 | O | VCC_EMB | Buffered μ C signal A18 (memory bus address bit A18) |
| 26A | b_A20 | O | VCC_EMB | Buffered μ C signal A20 (memory bus address bit A20) |
| 27A | GND | - | - | Ground |
| 28A | b_A23 | O | VCC_EMB | Buffered μ C signal A23 (memory bus address bit A23) |
| 29A | b_D9 | I/O | VCC_EMB | Buffered μ C signal D9 (memory bus data bit D9) |
| 30A | b_D10 | I/O | VCC_EMB | Buffered μ C signal D10 (memory bus data bit D10) |
| 31A | b_D12 | I/O | VCC_EMB | Buffered μ C signal D12 (memory bus data bit D12) |
| 32A | GND | - | - | Ground |
| 33A | b_D15 | I/O | VCC_EMB | Buffered μ C signal D15 (memory bus data bit D15) |
| 34A | b_BLS0 | O | VCC_EMB | Buffered μ C signal BLS0 (memory bus byte lane select 0) |
| 35A | b_BLS2 | O | VCC_EMB | Buffered μ C signal BLS2 (memory bus byte lane select 2) |
| 36A | N/C | - | - | Not connected |
| 37A | GND | - | - | Ground |
| 38A | b_D17 | I/O | VCC_EMB | Buffered μ C signal D17 (memory bus data bit D17) |
| 39A | b_D19 | I/O | VCC_EMB | Buffered μ C signal D19 (memory bus data bit D19) |
| 40A | b_D20 | I/O | VCC_EMB | Buffered μ C signal D20 (memory bus data bit D20) |
| 41A | b_D22 | I/O | VCC_EMB | Buffered μ C signal D22 (memory bus data bit D22) |
| 42A | GND | - | - | Ground |
| 43A | b_D25 | I/O | VCC_EMB | Buffered μ C signal D25 (memory bus data bit D25) |
| 44A | b_D27 | I/O | VCC_EMB | Buffered μ C signal D27 (memory bus data bit D27) |
| 45A | b_D28 | I/O | VCC_EMB | Buffered μ C signal D28 (memory bus data bit D28) |
| 46A | b_D30 | I/O | VCC_EMB | Buffered μ C signal D30 (memory bus data bit D30) |
| 47A | GND | - | - | Ground |
| 48A | LCD21 | O | VCC | μ C signal LCD21 (blue color bit) |
| 49A | LCD20 | O | VCC | μ C signal LCD20 (blue color bit) |
| 50A | LCD19 | O | VCC | μ C signal LCD19 (blue color bit) |
| 51A | LCD17 | O | VCC | μ C signal LCD17 (blue color bit) |
| 52A | GND | - | - | Ground |
| 53A | LCD14 | O | VCC | μ C signal LCD14 (green color bit) |
| 54A | LCD13 | O | VCC | μ C signal LCD13 (green color bit) |
| 55A | LCD11 | O | VCC | μ C signal LCD11 (green color bit) |
| 56A | LCD10 | O | VCC | μ C signal LCD10 (green color bit) |
| 57A | GND | - | - | Ground |
| 58A | LCD7 | O | VCC | μ C signal LCD7 (red color bit) |
| 59A | LCD4 | O | VCC | μ C signal LCD4 (red color bit) |
| 60A | LCD3 | O | VCC | μ C signal LCD3 (red color bit) |
| 61A | LDC0 | O | VCC | μ C signal LCD0 (red color bit) |

Table 2-1. Pin Descriptions, phyCORE-Connector X2, Row A (Continued)

| Pin # | Signal | I/O | SL | Description |
|-------|---------|-----|-----|--|
| 62A | GND | - | - | Ground |
| 63A | LCDFP | O | VCC | μC signal LCDFP (STN frame pulse/TFT vertical sync) |
| 64A | LCDLP | O | VCC | μC signal LCDLP (STN line pulse/TFT horizontal sync) |
| 65A | LCDCP | O | VCC | μC signal LCDCP (pixel clock) |
| 66A | LCDLE | O | VCC | μC signal LCDLE (line end) |
| 67A | GND | - | - | Ground |
| 68A | MS_DIO0 | I/O | VCC | μC signal MS_DIO0 (MMC/SD data I/O 0) |
| 69A | MS_DIO2 | I/O | VCC | μC signal MS_DIO2 (MMC/SD data I/O 2) |
| 70A | MS_BS | I/O | VCC | μC signal MS_BS (MMC/SD command I/O) |
| 71A | MS_SCLK | O | - | μC signal MS_SCLK (MMC/SD clock output) |
| 72A | GND | - | - | Ground |
| 73A | TMS | I | VCC | μC signal TMS (JTAG test mode select) |
| 74A | TDI | I | VCC | μC signal TDI (JTAG test data input) |
| 75A | /TRST | I | VCC | μC signal /TRST (JTAG test logic reset) |
| 76A | N/C | - | - | Not connected |
| 77A | GND | - | - | Ground |
| 78A | N/C | - | - | Not connected |
| 79A | N/C | - | - | Not connected |
| 80A | N/C | - | - | Not connected |

Table 2-2. Pin Descriptions, phyCORE-Connector X2, Row B

| Pin # | Signal | I/O | SL | Description |
|-------|--------|-----|---------|---|
| 1B | N/C | - | - | Not connected |
| 2B | N/C | - | - | Not connected |
| 3B | N/C | - | - | Not connected |
| 4B | GND | - | - | Ground |
| 5B | b_/CS3 | O | VCC_EMB | Buffered μC signal /CS3 (memory bus chip select 3) |
| 6B | b_/CS2 | O | VCC_EMB | Buffered μC signal /CS2 (memory bus chip select 2) |
| 7B | b_/OE | O | VCC_EMB | Buffered μC signal /OE (memory bus output enable) |
| 8B | b_A0 | O | VCC_EMB | Buffered μC signal A0 (memory bus address bit A0) |
| 9B | GND | - | - | Ground |
| 10B | b_A3 | O | VCC_EMB | Buffered μC signal A3 (memory bus address bit 3) |
| 11B | b_A5 | O | VCC_EMB | Buffered μC signal A5 (memory bus address bit A5) |
| 12B | b_A6 | O | VCC_EMB | Buffered μC signal A6 (memory bus address bit A6) |
| 13B | b_A8 | O | VCC_EMB | Buffered μC signal A8 (memory bus address bit A8) |
| 14B | GND | - | - | Ground |
| 15B | b_A11 | O | VCC_EMB | Buffered μC signal A11 (memory bus address bit A11) |

Table 2-2. Pin Descriptions, phyCORE-Connector X2, Row B (Continued)

| Pin # | Signal | I/O | SL | Description |
|-------|--------|-----|---------|--|
| 16B | b_A13 | O | VCC_EMB | Buffered μ C signal A13 (memory bus address bit A13) |
| 17B | b_A14 | O | VCC_EMB | Buffered μ C signal A14 (memory bus address bit A14) |
| 18B | b_D0 | I/O | VCC_EMB | Buffered μ C signal D0 (memory bus data bit D0) |
| 19B | GND | - | - | Ground |
| 20B | b_D3 | I/O | VCC_EMB | Buffered μ C signal D3 (memory bus data bit D3) |
| 21B | b_D5 | I/O | VCC_EMB | Buffered μ C signal D5 (memory bus data bit D5) |
| 22B | b_D6 | I/O | VCC_EMB | Buffered μ C signal D6 (memory bus data bit D6) |
| 23B | b_A16 | O | VCC_EMB | Buffered μ C signal A16 (memory bus address bit A16) |
| 24B | GND | - | - | Ground |
| 25B | b_A19 | O | VCC_EMB | Buffered μ C signal A19 (memory bus address bit A19) |
| 26B | b_A21 | O | VCC_EMB | Buffered μ C signal A21 (memory bus address bit A21) |
| 27B | b_A22 | O | VCC_EMB | Buffered μ C signal A22 (memory bus address bit A22) |
| 28B | b_D8 | I/O | VCC_EMB | Buffered μ C signal D8 (memory bus data bit D8) |
| 29B | GND | - | - | Ground |
| 30B | b_D11 | I/O | VCC_EMB | Buffered μ C signal D11 (memory bus data bit D11) |
| 31B | b_D13 | I/O | VCC_EMB | Buffered μ C signal D13 (memory bus data bit D13) |
| 32B | b_D14 | I/O | VCC_EMB | Buffered μ C signal D14 (memory bus data bit D14) |
| 33B | b_BLS1 | O | VCC_EMB | Buffered μ C signal BLS1 (memory bus byte lane select 1) |
| 34B | GND | - | - | Ground |
| 35B | b_BLS3 | O | VCC_EMB | Buffered μ C signal BLS3 (memory bus byte lane select 3) |
| 36B | N/C | - | - | Not connected |
| 37B | b_D16 | I/O | VCC_EMB | Buffered μ C signal D16 (memory bus data bit D16) |
| 38B | b_D18 | I/O | VCC_EMB | Buffered μ C signal D18 (memory bus data bit D18) |
| 39B | GND | - | - | Ground |
| 40B | b_D21 | I/O | VCC_EMB | Buffered μ C signal D21 (memory bus data bit D21) |
| 41B | b_D23 | I/O | VCC_EMB | Buffered μ C signal D23 (memory bus data bit D23) |
| 42B | b_D24 | I/O | VCC_EMB | Buffered μ C signal D24 (memory bus data bit D24) |
| 43B | b_D26 | I/O | VCC_EMB | Buffered μ C signal D26 (memory bus data bit D26) |
| 44B | GND | - | - | Ground |
| 45B | b_D29 | I/O | VCC_EMB | Buffered μ C signal D29 (memory bus data bit D29) |
| 46B | b_D31 | I/O | VCC_EMB | Buffered μ C signal D31 (memory bus data bit D31) |
| 47B | LCD23 | O | VCC | μ C signal LCD23 (blue color bit) |
| 48B | LCD22 | O | VCC | μ C signal LCD22 (blue color bit) |
| 49B | GND | - | - | Ground |
| 50B | LCD18 | O | VCC | μ C signal LCD18 (blue color bit) |
| 51B | LCD16 | O | VCC | μ C signal LCD16 (blue color bit) |
| 52B | LCD15 | O | VCC | μ C signal LCD15 (green color bit) |
| 53B | LCD12 | O | VCC | μ C signal LCD12 (green color bit) |

Table 2-2. Pin Descriptions, phyCORE-Connector X2, Row B (Continued)

| Pin # | Signal | I/O | SL | Description |
|-------|----------|-----|-----|---|
| 54B | GND | - | - | Ground |
| 55B | LCD9 | O | VCC | μC signal LCD9 (green color bit) |
| 56B | LCD8 | O | VCC | μC signal LCD8 (green color bit) |
| 57B | LCD6 | O | VCC | μC signal LCD6 (red color bit) |
| 58B | LCD5 | O | VCC | μC signal LCD5 (red color bit) |
| 59B | GND | - | - | Ground |
| 60B | LCD2 | O | VCC | μC signal LCD2 (red color bit) |
| 61B | LCD1 | O | VCC | μC signal LCD1 (red color bit) |
| 62B | LCDPWR | O | VCC | μC signal LCDPWR (panel power enable) |
| 63B | LCDCLKIN | I | VCC | μC signal LCDCLKIN (optional clock input signal) |
| 64B | GND | - | - | Ground |
| 65B | LCDAC | O | VCC | μC signal LCDAC (STN AC bias/TFT data enable) |
| 66B | MS_DIO1 | I/O | VCC | μC signal MS_DIO1 (MMC/SD data I/O 1) |
| 67B | MS_DIO3 | I/O | VCC | μC signal MS_DIO3 (MMC/SD data I/O 3) |
| 68B | N/C | - | - | Not connected |
| 69B | GND | - | - | Ground |
| 70B | TDO | O | VCC | μC signal TMS (JTAG test data output) |
| 71B | TCK | I | VCC | μC signal TMS (JTAG test clock input); Internal 10k pull-down |
| 72B | RTCK | O | VCC | μC signal TMS (JTAG test clock return output); Internal 10k pull-down |
| 73B | DBGEN | I | VCC | μC signal DBGEN (JTAG/boundary scan select) |
| 74B | GND | - | - | Ground |
| 75B | N/C | - | - | Not connected |
| 76B | N/C | - | - | Not connected |
| 77B | N/C | - | - | Not connected |
| 78B | N/C | - | - | Not connected |
| 79B | GND | - | - | Ground |
| 80B | N/C | - | - | Not connected |

Table 2-3. Pin Descriptions, phyCORE-Connector X2, Row C

| Pin # | Signal | I/O | SL | Description |
|-------|----------|-----|--------------------------|--|
| 1C | VCC | I | 3.15V | 3.15V primary voltage supply input |
| 2C | VCC | I | 3.15V | 3.15V primary voltage supply input |
| 3C | GND | - | - | Ground |
| 4C | VCC_SDIO | I | 2.25 – 3.6V ^a | SDIO controller voltage interface select |
| 5C | VCC_SDIO | I | 2.25 – 3.6V ^b | SDIO controller voltage interface select |

Table 2-3. Pin Descriptions, phyCORE-Connector X2, Row C (Continued)

| Pin # | Signal | I/O | SL | Description |
|-------|-------------|-----|-------------------|---|
| 6C | VBAT | I | 3.0V | 3.0V battery backup input for sleep conditions. This supply must be present for deep sleep. |
| 7C | GND | - | - | Ground |
| 8C | N/C | - | - | Not connected |
| 9C | /SERVICE | I | 3.15V | μC signal /SERVICE/GPI_01. This signal has an internal 100k pull-up. |
| 10C | /RESET_SYS | O | 3.15V | Open-drain system reset output with internal 10k pull-up. Connect this to external 3.15V devices requiring a power-up, power-fail, or power-down reset. |
| 11C | /RESOUT | O | 1.8V | μC generated reset output. Connect this to external 1.8V devices required a power-up, power-fail, or power-down reset. |
| 12C | GND | - | 0 | Ground |
| 13C | /RESET_BAT | O | 3.0V | Open-drain RTC and SDRAM power supply supervisor reset output with internal 10k pull-up. Connect this to external 3.0V devices requiring a power-up, power-fail, or power-down reset. This signal is typically used with external deep sleep control logic. |
| 14C | N/C | - | - | Not connected |
| 15C | N/C | - | - | Not connected |
| 16C | N/C | - | - | Not connected |
| 17C | GND | - | - | Ground |
| 18C | /FLASH_WP | I | VCC_EMB | NOR flash write protect input with internal 10k pull-up. Drive this signal low to prevent write access to the NOR flash. |
| 19C | U5_RX | I | 3.15V | μC signal U5_RX |
| 20C | U5_TX | O | 3.15V | μC signal U5_TX |
| 21C | U5_RX_RS232 | I | 6.4V ^c | U5_RX converted to RS-232 levels |
| 22C | GND | - | - | Ground |
| 23C | U5_TX_RS232 | O | 6.4V ^c | U5_TX converted to RS-232 levels |
| 24C | U3_TX | O | 3.15V | μC signal U3_TX |
| 25C | U3_RX | | 3.15V | μC signal U3_RX |
| 26C | U3_CTS | I | 3.15V | μC signal U3_CTS/U2_HCTS |
| 27C | GND | - | - | Ground |
| 28C | U3_DCD | I | 3.15V | μC signal U3_DCD/GPI_05 |
| 29C | U6_IRTX | O | 3.15V | μC signal U6_IRTX |
| 30C | I2C2_SCL | O | 1.8V | μC signal I2C2_SCL. This signal has an internal 2.2k pull-up. |
| 31C | I2C1_SCL | O | 3.15V | μC signal I2C1_SCL. This signal has an internal 2.2k pull-up. |
| 32C | GND | - | - | Ground |

Table 2-3. Pin Descriptions, phyCORE-Connector X2, Row C (Continued)

| Pin # | Signal | I/O | SL | Description |
|-------|---------------|-----|-------------------|---|
| 33C | ENET_LINK | O | 3.15V | Ethernet link status output. Typically this is connected to a link LED to indicate Ethernet link status. |
| 34C | ENET_ACTIVITY | O | 3.15V | Ethernet activity status output. Typically this is connected to an activity LED to indicated Ethernet activity status. |
| 35C | ENET_RXN | I | Note ^d | Ethernet negative differential receive input |
| 36C | ENET_RXP | I | Note ^d | Ethernet positive differential receive input |
| 37C | GND | - | - | Ground |
| 38C | GPIO_0 | I/O | 3.15V | μC signal GPIO_00 |
| 39C | GPI_3 | I | 1.8V | μC signal GPI_03 |
| 40C | GPI_19 | I | 3.15V | μC signal GPI_19 |
| 41C | GPO_0 | O | 1.8V | μC signal GPO_00/TST_CLK1 |
| 42C | GND | - | - | Ground |
| 43C | GPO_5 | O | 1.8V | μC signal GPO_05 |
| 44C | GPO_14 | O | 1.8V | μC signal GPO_14 |
| 45C | GPO_19 | O | 1.8V | μC signal GPO_19. This signal defaults to NAND Flash write protection control via jumper J5 with an internal 100k pull-up. See section 9.2 for details. |
| 46C | USB_ADR/PSW | I/O | 1.8V | USB OTG address select input/power supply control output. On power-up this signal is latched as the lower USB transceiver address bit and can be reconfigured as a power supply control output to control an external 5.0V power supply in HOST mode. This signal has an internal 100k pull-down. |
| 47C | GND | - | - | Ground |
| 48C | USB_VBUS | I/O | 5.0V | USB OTG VBUS input and output. This signal supplies up to 8mA when operating as an embedded OTG Host. |
| 49C | SCK0 | I/O | 3.15V | μC signal SCK0/SPI1_CLK. This signal is connected to the on-board SPI bootable EEPROM. |
| 50C | MISO0 | I/O | 3.15V | μC signal MISO0/SPI1_DATIN. This signal is connected to the on-board SPI bootable EEPROM and has an internal 10k pull-up. |
| 51C | SSEL0 | I/O | 3.15V | μC signal SSEL0/GPIO_05. This signal is connected to the on-board SPI bootable EEPROM and has an internal 10k pull-up. |
| 52C | GND | - | - | Ground |
| 53C | I2STX_CLK1 | I/O | 3.15V | μC signal I2STX_CLK1/MAT3.0 |
| 54C | I2STX_SDA1 | I/O | 3.15V | μC signal I2STX_SDA1/MAT3.1 |
| 55C | I2STX_WS1 | I/O | 3.15V | μC signal I2STX_WS1/CAP3.0 |
| 56C | ENET_RXD2 | I | 3.15V | μC signal ENET_RXD2/GPI_00 |
| 57C | GND | - | - | Ground |
| 58C | ENET_CRS | I | 3.15V | μC signal ENET_CRS/KEY_COL3 |

Table 2-3. Pin Descriptions, phyCORE-Connector X2, Row C (Continued)

| Pin # | Signal | I/O | SL | Description |
|-------|------------|-----|----------|--|
| 59C | ENET_MDIO | I/O | 3.15V | μC signal ENET_MDIO/GPIO_03/KEY_ROW7 |
| 60C | ENET_RX_ER | I | 3.15V | μC signal ENET_RX_ER/KEY_COL2 |
| 61C | ENET_TX_ER | I/O | 3.15V | μC signal ENET_TX_ER/KEY_ROW0 |
| 62C | GND | - | - | Ground |
| 63C | ENET_TX_EN | I/O | 3.15V | μC signal ENET_TX_EN/KEY_ROW3 |
| 64C | ENET_RXD3 | I | 3.15V | μC signal ENET_RXD3/GPI_02/CAP2.0 |
| 65C | ENET_RXD1 | I | 3.15V | μC signal ENET_RXD1/KEY_COL5 |
| 66C | ENET_TXD3 | I/O | 3.15V | μC signal ENET_TXD3/KEY_ROW2 |
| 67C | GND | - | - | Ground |
| 68C | ENET_TXD0 | I/O | 3.15V | μC signal ENET_TXD0/KEY_ROW4 |
| 69C | /SDIO_CD | I | VCC_SDIO | SDIO controller card detect signal with internal 100k pull-up. |
| 70C | SDIO_POW1 | I | VCC_SDIO | SDIO controller power control signal 1 output |
| 71C | SDIO_CMD | I/O | VCC_SDIO | SDIO controller command input/output |
| 72C | GND | - | - | Ground |
| 73C | SDIO_D1 | I/O | VCC_SDIO | SDIO controller data 1 input/output |
| 74C | SDIO_D2 | I/O | VCC_SDIO | SDIO controller data 2 input/output |
| 75C | SDIO_D4 | I/O | VCC_SDIO | SDIO controller data 4 input/output |
| 76C | SDIO_D7 | I/O | VCC_SDIO | SDIO controller data 7 input/output |
| 77C | AGND | - | - | Analog ground |
| 78C | TS_XOUT | I/O | 3.15V | μC signal TS_XOUT |
| 79C | ADIN1 | I | 3.15V | μC signal ADIN1 |
| 80C | ADIN0 | I | 3.15V | μC signal ADIN0 |

- a. See the NXP SDIO101 datasheet for details.
- b. See the NXP SDIO101 datasheet for details.
- c. Typical -- See ADM3307 datasheet for details.
- d. See LAN8700I datasheet for details.

Table 2-4. Pin Descriptions, phyCORE-Connector X2, Row D

| Pin # | Signal | I/O | SL | Description |
|-------|------------|-----|-------|--|
| 1D | VCC | I | 3.15V | 3.15V primary voltage supply input |
| 2D | VCC | I | 3.15V | 3.15V primary voltage supply input |
| 3D | GND | - | - | Ground |
| 4D | VCC_AD_EXT | I | 3.15V | μC ADC power supply input |
| 5D | VCC_AD_EXT | I | 3.15V | μC ADC power supply input |
| 6D | N/C | - | - | Not connected |
| 7D | N/C | - | - | Not connected |
| 8D | WDI | I | 3.15V | Watchdog input. Connect this pin to an applicable signal to periodically reset the watchdog timer. |

Table 2-4. Pin Descriptions, phyCORE-Connector X2, Row D (Continued)

| Pin # | Signal | I/O | SL | Description |
|-------|-------------|-----|----------------------------|---|
| 9D | GND | - | - | Ground |
| 10D | /RESIN | I | 3.0V ^a or 3.15V | System reset input. Connect this pin to an open-drain output and momentarily pull LOW to initiate a system reset. Do not connect this pin to a push-pull output or any other pull-up/pull-down circuitry. |
| 11D | N/C | - | - | Not connected |
| 12D | N/C | - | - | Not connected |
| 13D | N/C | - | - | Not connected |
| 14D | GND | - | - | Ground |
| 15D | N/C | - | - | Not connected |
| 16D | U1_RX | I | 3.15V | μC signal U1_RX/CAP1.0 |
| 17D | U1_TX | O | 3.15V | μC signal U1_TX |
| 18D | GPO_20 | O | 1.8V | μC signal GPO_20 |
| 19D | GND | - | - | Ground |
| 20D | /RS232_EN | I | 3.15V | UART 5/UART 1 RS-232 transceiver enable input. This signal has an internal 100k pull-down. |
| 21D | RS232_SD | I | 3.15V | UART 5/UART 1 RS-232 transceiver shut down input. This signal has an internal 100k pull-down. |
| 22D | U1_RX_RS232 | I | 6.4V ^b | U1_RX converted to RS-232 levels |
| 23D | U1_TX_RS232 | O | 6.4V ^b | U1_TX converted to RS-232 levels |
| 24D | GND | - | - | Ground |
| 25D | U3_DSR | I/O | 3.15V | μC signal U3_DSR/U2_RX |
| 26D | U3_DTR | O | 3.15V | μC signal U3_DTR/U2_TX |
| 27D | U3_RTS | O | 3.15V | μC signal U3_RTS/U2_HRTS/GPO_23 |
| 28D | U3_RI | I | 3.15V | μC signal U3_RI/GPI_11 |
| 29D | GND | - | - | Ground |
| 30D | U6_IRRX | I | 3.15V | μC signal U6_IRRX |
| 31D | I2C2_SDA | I/O | 1.8V | μC signal I2C2_SDA. This signal has an internal 2.2k pull-up. |
| 32D | I2C1_SDA | I/O | 3.15V | μC signal I2C1_SDA. This signal has an internal 2.2k pull-up. |
| 33D | /RTC_INT | O | 3.0V | Off-chip Real Time Clock interrupt alarm open-drain output. This pin has an optional 100k internal pull-up.[3] |
| 34D | GND | - | - | Ground |
| 35D | ENET_TXN | O | Note ^c | Ethernet negative differential transmit output |
| 36D | ENET_TXP | O | Note ^c | Ethernet positive differential transmit output |
| 37D | ENET_CLKEN | I | 3.15V | Ethernet clock enable. This pin has an internal 100k pull-up. Ground this pin to disable the ethernet clock. Typically this is used in a low power mode. |

Table 2-4. Pin Descriptions, phyCORE-Connector X2, Row D (Continued)

| Pin # | Signal | I/O | SL | Description |
|-------|--------------|-----|-------------------|---|
| 38D | GPIO_1 | I/O | 3.15V | μC signal GPIO_01 |
| 39D | GND | - | - | Ground |
| 40D | GPI_7 | I | 3.15V | μC signal GPI_07/PCAP3.0. This signal is used as the SDIO controller interrupt input and has an internal 10k pull-up. |
| 41D | GPO_1 | O | 1.8V | μC signal GPO_01 |
| 42D | GPO_4 | O | 3.15V | μC signal GPO_04 |
| 43D | GPO_11 | O | 3.15V | μC signal GPO_11 |
| 44D | GND | - | - | Ground |
| 45D | GPO_17 | O | 3.15V | μC signal GPO_17 |
| 46D | USB_ID | I | Note ^d | USB OTG ID pin. Normally this pin is connected directly to the ID pin on an OTG connector. |
| 47D | USB_D+ | I/O | Note ^d | USB positive differential input/output |
| 48D | USB_D- | I/O | Note ^d | USB negative differential input/output |
| 49D | GND | - | - | Ground |
| 50D | MOSI0 | I/O | 3.15V | μC signal MOSI0/SPI1_DATIO |
| 51D | GPI_4 | I | 3.15V | μC signal GPI_04/SPI1_BUSY |
| 52D | ONSW | O | 1.2V | μC signal ONSW |
| 53D | N/C | - | - | Not connected |
| 54D | GND | - | - | Ground |
| 55D | I2SRX_CLK1 | I/O | 3.15V | μC signal I2SRX_CLK1/P0.0 |
| 56D | I2SRX_SDA1 | I | 3.15V | μC signal I2SRX_SDA1/HSTIM_CAP/GPI_06 |
| 57D | I2SRX_WS1 | I/O | 3.15V | μC signal I2SRX_WS1/P0.1 |
| 58D | ENET_COL | I | 3.15V | μC signal ENET_COL/KEY_COL7/GPI_09 |
| 59D | GND | - | - | Ground |
| 60D | ENET_MDC | I/O | 3.15V | μC signal ENET_MDC/KEY_ROW6/GPIO_02 |
| 61D | ENET_RX_DV | I | 3.15V | μC signal ENET_RX_DV/SPI2_BUSY/KEY_COL6/GPI_08 |
| 62D | ENET_REF_CLK | I | 3.15V | μC signal ENET_REF_CLK/ENET_RX_CLK/KEY_COL1 |
| 63D | ENET_TX_CLK | I | 3.15V | μC signal ENET_TX_CLK/KEY_COL0 |
| 64D | GND | - | - | Ground |
| 65D | ENET_RXD0 | I | 3.15V | μC signal ENET_RXD0/KEY_COL4 |
| 66D | ENET_TXD2 | I/O | 3.15V | μC signal ENET_TXD2/KEY_ROW1 |
| 67D | ENET_TXD1 | I/O | 3.15V | μC signal ENET_TXD1/KEY_ROW5 |
| 68D | TST_CLK2 | O | 3.15V | μC signal TST_CLK2 |
| 69D | GND | - | - | Ground |
| 70D | /SDIO_WP | I | VCC_SDIO | SDIO controller write protect input. This pin has an internal 100k pull-up. |

Table 2-4. Pin Descriptions, phyCORE-Connector X2, Row D (Continued)

| Pin # | Signal | I/O | SL | Description |
|-------|-----------|-----|----------|---|
| 71D | SDIO_POW0 | O | VCC_SDIO | SDIO controller power control signal 1 output |
| 72D | SDIO_CLK | O | VCC_SDIO | SDIO controller clock output |
| 73D | SDIO_D0 | I/O | VCC_SDIO | SDIO controller data 0 input/output |
| 74D | GND | - | - | Ground |
| 75D | SDIO_D3 | I/O | VCC_SDIO | SDIO controller data 3 input/output |
| 76D | SDIO_D5 | I/O | VCC_SDIO | SDIO controller data 5 input/output |
| 77D | SDIO_D6 | I/O | VCC_SDIO | SDIO controller data 6 input/output |
| 78D | TS_YOUT | I/O | - | μC signal TS_YOUT |
| 79D | AGND | - | - | Analog ground |
| 80D | ADIN2 | I | 3.15V | μC signal ADIN2 |

- a. 3.0V is the standard phyCORE-LPC3250 SOM configuration.
- b. Typical -- see ADM3307 datasheet for details.
- c. See the LAN8700I datasheet for details.
- d. See the ISP1301 datasheet for details.

3 Jumpers

For configuration purposes, the phyCORE-LPC3250 has 24 solder jumpers, some of which have been installed prior to delivery. [Figure 3-1](#) and [Figure 3-2](#) indicate the location of the solder jumpers on the board. There are 11 solder jumpers located on the top side of the module (opposite side of connectors) and 13 solder jumpers on the bottom side.

If manual jumper modification is required be sure to pay special attention to the "TYPE" column to ensure you are using the correct type of jumper (0 Ohms, 10k Ohms, etc...). All jumpers are 0805 package with a 1/8W or better power rating.

Three and four position jumpers have pin 1 marked with a GREEN pad.

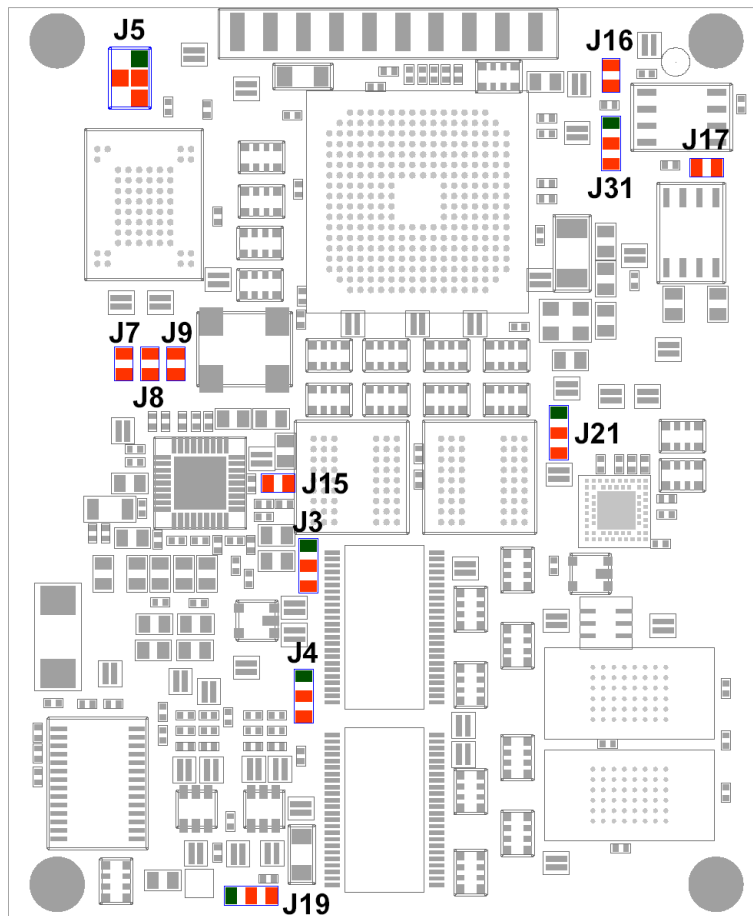

Fig. 3-1. Jumper Locations (Controller Side)

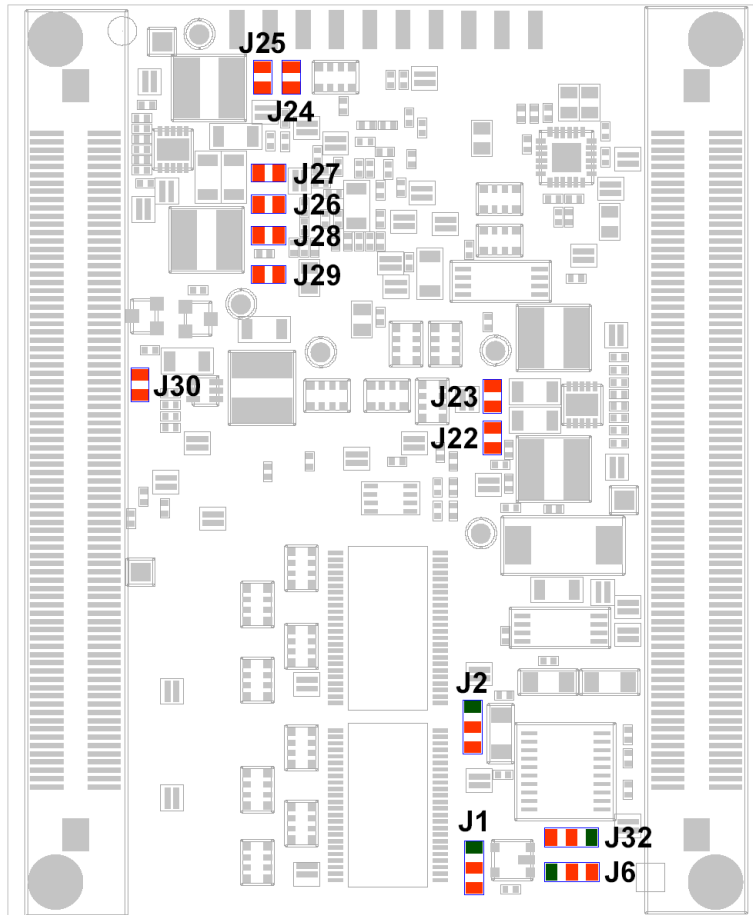

Fig. 3-2. Jumper Locations (Connector Side)

Table 3-1 below provides a functional summary of the solder jumpers, their default positions, and possible alternative positions and functions. A detailed description of each solder jumper can be found in the applicable chapter listed in the table.

Table 3-1. Jumper Settings

| J | Type | Setting | Description | Chapter |
|----|------|---------|---|---------|
| J1 | 0R | 1+2 | Data bus buffer D16...23 output enable controlled by processor signal BLS2. | 13 |
| | | 2+3 | Data bus buffer D16...23 output permanently enabled. | |
| J2 | 0R | 1+2 | Data bus buffer D24...31 output enable controlled by processor signal BLS3. | 13 |
| | | 2+3 | Data bus buffer D24...31 output permanently enabled. | |
| J3 | 0R | 1+2 | Data bus buffer D0...7 output enable controlled by processor signal BLS0. | 13 |
| | | 2+3 | Data bus buffer D0...7 output permanently enabled. | |
| J4 | 0R | 1+2 | Data bus buffer D8...15 output enable controlled by processor signal BLS1. | 13 |
| | | 2+3 | Data bus buffer D8...15 output permanently enabled. | |

Table 3-1. Jumper Settings (Continued)

| J | Type | Setting | Description | Chapter |
|------------|-------------|----------------|---|----------------|
| J5 | 0R | 1+2 | NAND Flash write protected during power-up, power-fail, and power-down events by the controller /RESOUT signal. | 9.2 |
| | | 2+3 | NAND Flash permanently write protected. | |
| | | 2+4 | NAND Flash write protection controlled via GPO_19. | |
| | | Open | NAND Flash permanently write enabled. | |
| J6 | 0R | 1+2 | Activating /RESIN produces a system /RESET_SYS event. | N/A |
| | | 2+3 | Activating /RESIN produces a system /RESET_SYS and a /RESET_BAT event. | |
| J7 | 10k | Open | Ethernet PHY operation MODE0 bit = 1. | 10.2 |
| | | Closed | Ethernet PHY operation MODE0 bit = 0. | |
| J8 | 10k | Open | Ethernet PHY operation MODE1 bit = 1. | 10.2 |
| | | Closed | Ethernet PHY operation MODE1 bit = 0. | |
| J9 | 10k | Open | Ethernet PHY operation MODE2 bit = 1. | 10.2 |
| | | Closed | Ethernet PHY operation MODE2 bit = 0. | |
| J16 | 0R | Open | µC signal SSEL0 disconnected from on-board SPI EEPROM /CS0 input. | 9.5 |
| | | Closed | µC signal SSEL0 connected to on-board SPI EEPROM /CS0 input. | |
| J17 | 0R | Open | Watchdog extended mode selected. Timeout period ~6s. | 7 |
| | | Closed | Watchdog normal mode selected. Timeout period ~12ms. | |
| J19 | 0R | 1+2 | External watchdog reset forces a system wide reset and sleep reset. | 7 |
| | | 2+3 | External watchdog reset forces a system wide reset. | |
| J21 | 0R | 1+2 | External memory bus voltage set to 1.8V. | 13.1 |
| | | 2+3 | External memory bus voltage set to 3.15V. | |
| J22 | 0R | Open | Voltage regulator U22 disconnected from VCC_RTC. | 4.5.3 |
| | | Closed | Voltage regulator U22 supplies VCC_RTC power. | |
| J23 | 0R | Open | Voltage regulator U22 disconnected from VCC_SDRAM. | 4.5.3 |
| | | Closed | Voltage regulator U22 supplies VCC_SDRAM power. | |
| J24 | 0R | Open | Voltage regulator U23 disconnected from VCC_SDRAM. | 4.5.1 |
| | | Closed | Voltage regulator U23 supplies VCC_SDRAM power. | |
| J25 | 0R | Open | Voltage regulator U23 disconnected from VCC_1V8. | 4.5.1 |
| | | Closed | Voltage regulator U23 supplies VCC_1V8 power. | |
| J26 | 0R | Open | Voltage regulator U23 disconnected from VCC_RTC. | 4.5.1 |
| | | Closed | Voltage regulator U23 supplies VCC_RTC power. | |
| J27 | 0R | Open | Voltage regulator U23 disconnected from VCC_CORE. | 4.5.1 |
| | | Closed | Voltage regulator U23 supplies VCC_CORE power. | |
| J28 | 0R | Open | Voltage regulator U23 disconnected from VCC_1V2. | 4.5.1 |
| | | Closed | Voltage regulator U23 supplies VCC_1V2 power. | |
| J29 | 0R | Open | Voltage regulator U27 disconnected from VCC_CORE. | 4.5.2 |
| | | Closed | Voltage regulator U27 supplies VCC_CORE power. | |

Table 3-1. Jumper Settings (Continued)

| J | Type | Setting | Description | Chapter |
|-----|------|---------|--|---------|
| J30 | 0R | Open | μ C signal LCD17/HIGHCORE disconnected from core voltage control. | 4.5.2 |
| | | Closed | μ C signal LCD17/HIGHCORE controls core voltage setting (0.9V or 1.2V). | |
| J31 | 10k | 1+2 | SPI EEPROM write enabled. | 9.5 |
| | | 2+3 | SPI EEPROM write protected. | |
| J32 | 0R | 1+2 | Off-chip RTC power is automatically selected between VCC and VBAT based on VCC presence. | 6 |
| | | 2+3 | Off-chip RTC power is powered by VBAT input only. | |

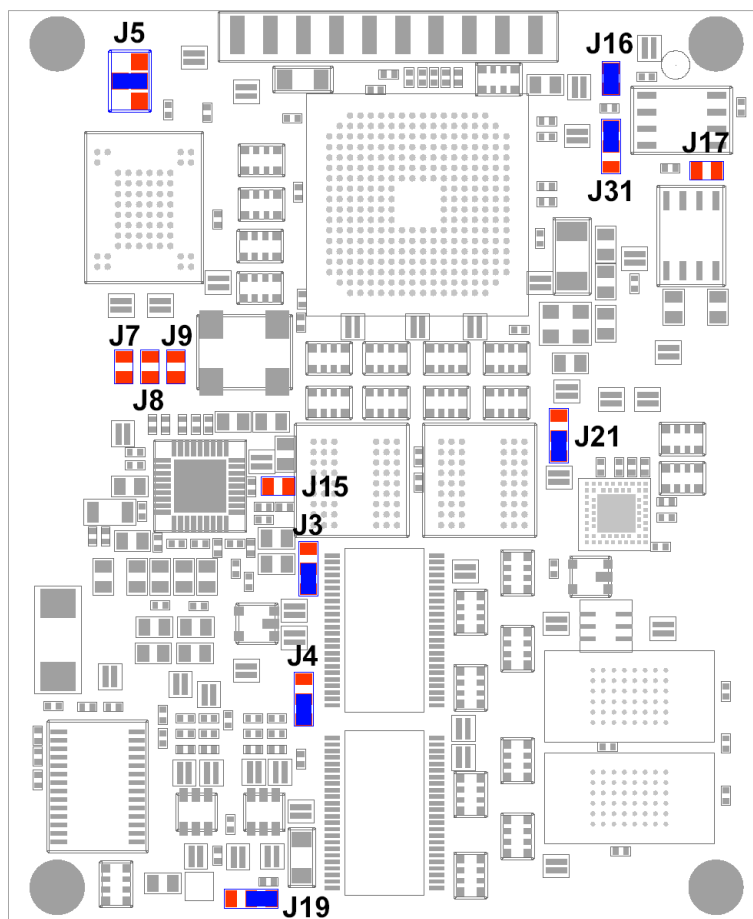
**Fig. 3-3. Default Jumper Settings (Controller Side)**

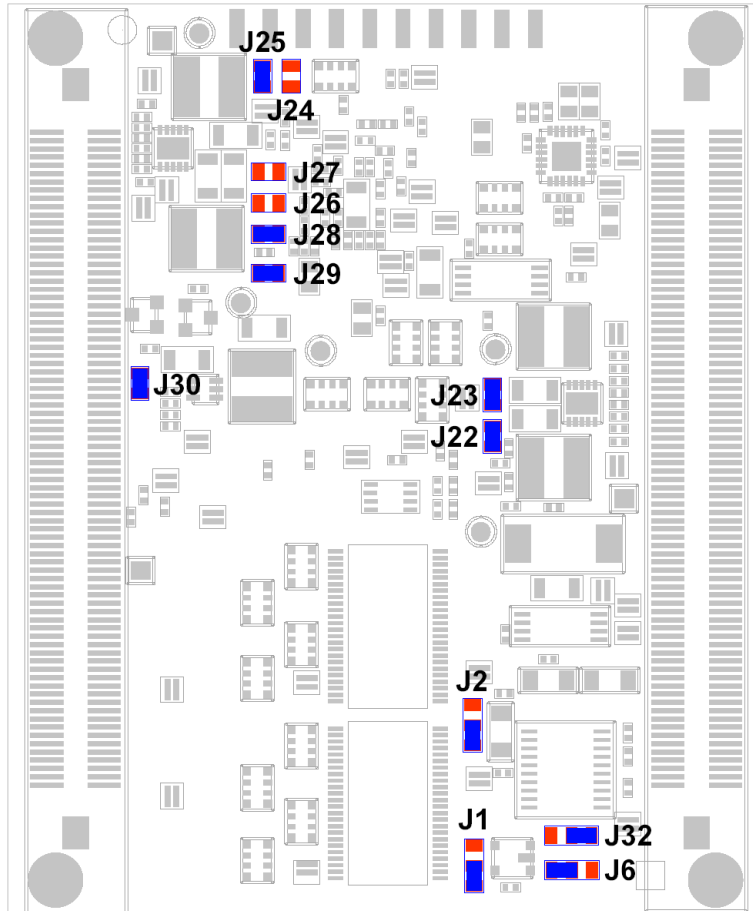

Fig. 3-4. Default Jumper Settings (Connector Side)

4 Power

The phyCORE-LPC3250 operates off of four separate power supply input domains. For systems that do not require maximum flexibility it is possible to operate the phyCORE-LPC3250 off of a single power supply voltage.

The following sections of this chapter discuss the primary power pins on the phyCORE-Connector X2 in detail.

4.1 Primary System Power (VCC)

The phyCORE-LPC3250 operates off of a primary voltage supply with a nominal value of 3.15V. On-board switching regulators generate the 1.8V, and 1.2V, and adjustable 0.9-1.2V voltage supplies required by the LPC3250 MCU and on-board components from the primary 3.15V supplied to the SOM.

For proper operation the phyCORE-LPC3250 must be supplied with a voltage source of $3.15V \pm 0.1V$ at the VCC pins on the phyCORE-Connector X2. See [Table 2-1](#) for VCC pin locations. See [Chapter 14](#) for current requirements.

Connect all +3.15V VCC input pins to your power supply and at least the matching number of GND pins neighboring the +3.15V pins.

CAUTION:

As a general design rule we recommend connecting all GND pins neighboring signals which are being used in the application circuitry. For maximum EMI performance all GND pins should be connected to a solid ground plane.

4.2 Secondary Battery Power (VBAT)

For applications requiring a low power deep sleep mode a secondary battery sleep supply with a nominal value of 3.0V is required. The battery supply powers the SDRAM and RTCs during a sleep condition, allowing primary system power (VCC) to be removed.

For deep sleep operation the phyCORE-LPC3250 must be supplied with a secondary voltage source of $3.0V \pm 0.1V$ at the VBAT pin on the phyCORE-Connector X2. See [Table 2-1](#) for the VBAT pin location. See [Chapter 14](#) for current requirements.

Applications not requiring a sleep mode can connect the VBAT pin to the primary system power supply (VCC = 3.15V).

4.3 Analog-to-Digital Converter Power (VCC_AD_EXT)

The LPC3250 Analog-to-Digital converter power domain pins are brought out to the phyCORE-Connector X2 for an optional external filtered power supply. See [Table 2-1](#) for the VCC_AD_EXT pin location. See the NXP LPC3250 datasheet for permissible input voltage ranges (2.7V to 3.3V as of the printing of this manual).

In general the VCC_AD_EXT pins will be connected to the primary VCC = 3.15V supply, requiring no special circuitry. The phyCORE-LPC3250 Carrier Board connects the VCC_AD_EXT pins through a 1R/4.7uF filter network from the primary VCC = 3.15V supply. Refer to the phyCORE-LPC3250 Carrier Board schematics for details.

4.4 SDIO Controller Power (VCC_SDIO)

The on-board SDIO controller is capable of a configurable interface voltage to meet the demands of the variety of SDIO devices with varying power requirements. In addition the SDIO controller is capable of switching between a high power and low power mode on-the-fly to optimize dynamic power consumption. The SDIO controller interface voltage is powered and set via the VCC_SDIO pins on the phyCORE-Connector X2. The high/low power switching is controlled via the SDIO_POW0 and SDIO_POW1 pins on the phyCORE-Connector X2. See the NXP SDIO101 datasheet for details on these power mode control pins. See [Table 2-1](#) for the locations of the applicable SDIO power and control pins.

For applications requiring an adjustable SDIO supply voltage the VCC_SDIO pins must be supplied with a voltage of 2.25-3.6V¹. See [Chapter 14](#) for current requirements. See the phyCORE-LPC3250 Carrier Board schematics for example adjustable supply circuitry. For SDIO applications which can operate off of 3.15V the VCC_SDIO pins can be connected directly to the VCC power supply and the SDIO_POW0/1 pins can be left unconnected.

4.5 On-board Voltage Regulators

The phyCORE-LPC3250 provides three on-board switching regulators to source the 1.2V, 1.8V, and adjustable 0.9-1.2V voltages required by the processor and on-board components. [Figure 4-1](#) presents a graphical depiction of the powering scheme. The jumpers in blue are by default populated, while the jumpers in white are unpopulated. By default U27 powers the VCC_CORE rail with an adjustable supply, U22 powers the VCC_RTC and VCC_SDRAM rails, and U23 powers the VCC_1V2 and VCC_1V8 rails. Notice that U22 generates 1.2V and 1.8V just as does U23. The reason for this is that U22 continues to power the RTC and SDRAM subsystems via backup battery during a sleep mode. See [Chapter 5](#) for details.

To reduce system costs U27 and U22 can be removed. To supply the power lost by the removal of these two regulators J26, J27, and J24 must be closed. [Figure 4-1](#) depicts the standard default configuration, but custom configurations can also be ordered. If your system does not require an adjustable core voltage to periodically lower core power consumption while keeping the system powered then U27 can be removed and J27 can be closed (note that the core is fixed at 1.2V in this case). If your system is not power conscious and does not need to enter a sleep mode during moments of processor inactivity to conserve power then U23 can be removed and J26 and J24 can be closed. This multi regulator + jumper approach provide cost and system requirement flexibility.

The following sections go into detail about each switching regulator and any associated configuration jumpers.

1. See the NXP SDIO101 datasheet for details.

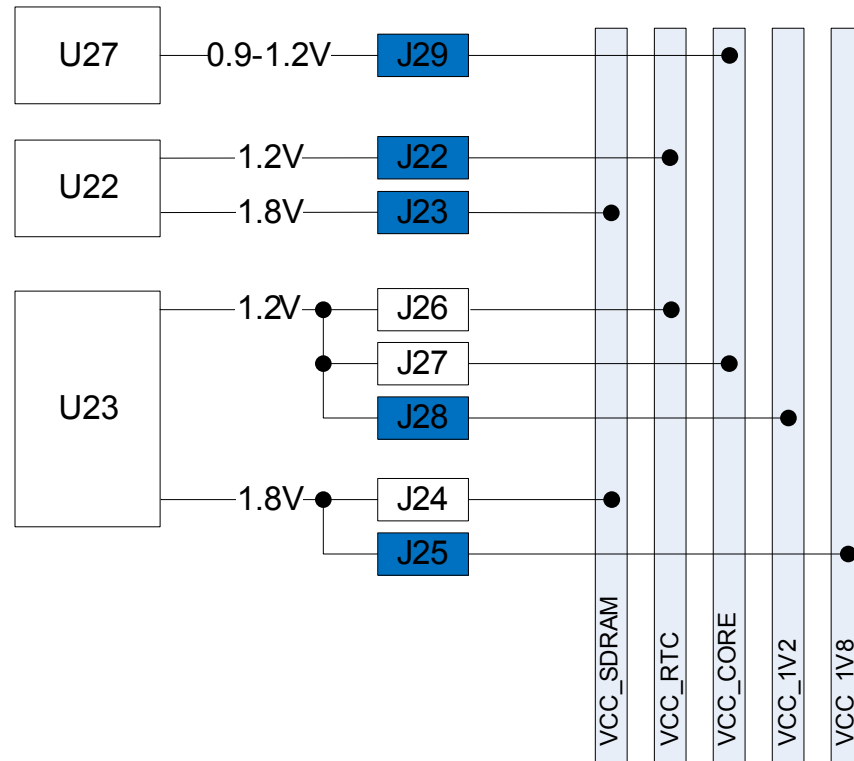

Fig. 4-1. phyCORE-LPC3250 On-board Powering Scheme

4.5.1 Primary 1.2V and 1.8V Supplies (U23)

The dual output switching regulator located at U23 generates the 1.2V and 1.8V core and peripheral supplies required by system components from the primary $VCC = 3.15V$ board supply. Various jumpers have been provided as current measurement access points on the outputs of both of these supplies. [Table 4-1](#) provides a summary of the jumpers and their operation. See [Chapter 4.5.4](#) for current measurement techniques with a precision shunt resistor.

Table 4-1. U23 1.2V/1.8V Primary Voltage Regulator Jumper Settings

| J | Type | Setting | Description |
|-----|------|---------|---|
| J24 | 0R | Open | Voltage regulator U23 disconnected from VCC_SDRAM. |
| | | Closed | Voltage regulator U23 supplies VCC_SDRAM power. <i>Do not close this unless U22 is unpopulated.</i> |
| J25 | 0R | Open | Voltage regulator U23 disconnected from VCC_1V8. |
| | | Closed | Voltage regulator U23 supplies VCC_1V8 power. |
| J26 | 0R | Open | Voltage regulator U23 disconnected from VCC_RTC. |
| | | Closed | Voltage regulator U23 supplies VCC_RTC power. <i>Do not close this unless U22 is unpopulated.</i> |
| J27 | 0R | Open | Voltage regulator U23 disconnected from VCC_CORE. |
| | | Closed | Voltage regulator U23 supplies VCC_CORE power. <i>Do not close this unless U22 is unpopulated.</i> |
| J28 | 0R | Open | Voltage regulator U23 disconnected from VCC_1V2. |
| | | Closed | Voltage regulator U23 supplies VCC_1V2 power. |

4.5.2 Adjustable Core Voltage Supply (U27)

The single output switching regulator located at U27 generates the adjustable 0.9V to 1.2V core supply to the processor from the primary VCC = 3.15V board supply. The regulator's output voltage is controlled by the processor's HIGHCORE signal (labeled as net LCD17). To set the core voltage to 0.9V set the HIGHCORE signal HIGH. To set the core voltage to 1.2V set the HIGHCORE signal LOW. The HIGHCORE signal can be automatically managed or manually controlled via the LPC3250 power management registers. See the LPC3250 User Manual for details.

Because the HIGHCORE signal is multiplexed with other peripherals, jumper J30 has been provided to allow disconnection of the HIGHCORE signal from controlling the core regulator output voltage. When J30 is disconnected the core regulator is fixed at 1.2V. This jumper is provided as a prototyping convenience. In practice an unneeded additional cost would be added by simply ordering a SOM configuration in which J30 is removed. If J30 is removed then the regulator is fixed at 1.2V and therefore an adjustable supply is no longer needed and instead can be satisfied by the dual 1.2V/1.8V regulator U23 through additional jumper configurations. A SOM without the need for an adjustable core would have U27 removed and J27 closed.

Output jumper J29 has been provided as current measurement access points for this supply. See [Chapter 4.5.4](#) for current measurement techniques with a precision shunt resistor.

4.5.3 SDRAM and RTC Supplies (U22)

The dual output switching regulator located at U23 generates the 1.2V and 1.8V RTC and SDRAM supplies required by the RTC and SDRAM. U23 gets its input power from the output of the battery switch located at U19. The battery switch is responsible for connecting VCC to the input of U23 during normal operating conditions (VCC is present) and VBAT to the input of U23 during sleep operations (VCC is shut down). This switchover between VCC and VBAT is automatic. Output jumpers have been provided as current measurement access points for both of these supplies. [Table 4-2](#) provides a summary of the jumpers and their operation. See [Chapter 4.5.4](#) for current measurement techniques with a precision shunt resistor.

Table 4-2. U22 RTC/SDRAM Voltage Regulator Jumper Settings

| J | Type | Setting | Description |
|-----|------|---------|--|
| J22 | 0R | Open | Voltage regulator U22 disconnected from VCC_SDRAM. |
| | | Closed | Voltage regulator U22 supplies VCC_SDRAM power. |
| J23 | 0R | Open | Voltage regulator U22 disconnected from VCC_RTC. |
| | | Closed | Voltage regulator U22 supplies VCC_RTC power. |

4.5.4 Selecting Shunt Resistors for Current Measurements

To make current measurements the 0 Ohm resistors populating the regulator output jumpers should be replaced by precision shunt resistors allowing the current draw to be calculated from the voltage measurement taken across the shunt resistor. When selecting a shunt resistor it is desirable to select a resistor large enough to give a voltage measurement that is not overtaken by noise. However, a larger shunt resistor means a larger voltage drop across the shunt resulting in a smaller output voltage. The output voltage after the shunt should be kept above the reset threshold. If the shunt resistor is too large the voltage at the output could be below the supervisor reset threshold and force the system into reset. A good starting place is a 0.025 Ohm precision shunt in a 0805 package.

4.6 Voltage Supervisor (U16, U17)

The phyCORE-LPC3250 comes equipped with two triple voltage supervisor IC's located at U16 and U17. These voltage supervisors are responsible for monitoring all on-board supply voltages (with the exception of the adjustable core supply voltage which is not monitored) and issuing a system reset during a power-up, power-fail, or power-down event.

U16 is the primary system supervisor which is responsible for monitoring the primary system supply voltage $VCC = 3.15V$, the fixed $VCC_1V8 = 1.8V$ peripheral supply voltage, and the fixed $VCC_1V2 = 1.2V$ core supply voltage. When any of the three supplies dip below their nominal reset threshold voltages for a predetermined amount of time the $/RESET_SYS$ signal is asserted LOW for the duration of the power fail event and is held low for an additional $200ms^1$ after the power fail event has cleared. The nominal reset thresholds for U16 are set at:

Table 4-3. Primary System Supervisor Reset Thresholds

| Supply Voltage | Nominal Reset Threshold |
|----------------|-------------------------|
| VCC (3.15V) | 3.0V |
| VCC_1V8 (1.8V) | 1.7V |
| VCC_1V2 (1.2V) | 1.1V |

U17 is the sleep mode supervisor and is responsible for monitoring the $VBAT = 3.0V$ input voltage, the $VCC_SDRAM = 1.8V$ SDRAM supply voltage, and the $VCC_RTC = 1.2V$ supply voltage. When any of the three supplies dip below their nominal reset threshold voltages for a predetermined amount of time the $/RESET_BAT$ and $/RESET_SYS$ signals are asserted LOW for the duration of the power fail event and are held low for an additional $200ms^1$ after the power fail event has cleared. The nominal reset thresholds for U17 are set at:

Table 4-4. Sleep System Supervisor Reset Thresholds

| Supply Voltage | Nominal Reset Threshold |
|------------------|-------------------------|
| VBAT (3.0V) | 2.8V |
| VCC_SDRAM (1.8V) | 1.7V |
| VCC_RTC (1.2V) | 1.1V |

The dual supervisor approach allows the creation of two separate reset signals: the system reset signal $/RESET_SYS$, and the sleep reset signal $/RESET_BAT$. The primary system supervisor U16 is capable of issuing a system reset via the $/RESET_SYS$ signal while the sleep supervisor U17 is capable of issuing a sleep reset via the $/RESET_BAT$ signal in addition to a system reset via the $/RESET_SYS$ signal. This method allows: (1) the processor to always be held in reset (via $/RESET_SYS$) when main system power is removed and (2) the detection of a power fail event during a sleep condition via the $/RESET_BAT$ signal. Condition (1) is required any time power is reapplied to the processor to ensure proper system startup after the reapplication of power. Condition (2) allows for additional external deep sleep/power control logic to be reset during a power fail event on the battery supplies (VBAT, VCC_RTC , or VCC_SDRAM). Since the LPC3250 does not provide sleep registers (however the on-chip RTC SRAM could potentially double for this) that are powered during a sleep condition the LPC3250 must rely on another method of determining it was in a sleep state upon a wake event. This could be done via writing a special code in the RTC scratch pad SRAM before entering sleep (a key value that indicates you were in sleep), however, a momentary fail on the supply could potentially corrupt SRAM in an area that did not affect the key or corrupt sections of SDRAM which are undetectable. In this instance the system would resume from a sleep condition where

1. Typical reset period. See Maxim IC MAX6710 datasheet for details.

data was corrupted, but have no method of determining so, resulting in a possible processor lockup. To prevent this from happening external sleep circuitry should be used which remembers the sleep state and is reset via the /RESET_BAT signal should a sleep supply (VBAT, VCC_RTC, VCC_SDRAM) fail.

5 Deep Sleep

The phyCORE-LPC3250 was designed to support a "deep sleep" mode where all primary system power is removed, leaving only a battery backup supply powering essential sleep functions. This mode was designed for ultra low power to extend primary system battery life in power critical applications. Note that this mode assumes the use of a battery as the primary system power source, but is not required. A wall adapter, or other power source can also be used but it is more typical that low power consumption is required when operating the system from a battery supply to maximize battery life.

Figure 5-1 depicts a typical sleep enabled powering system where the entire system is powered from a battery. The battery is then regulated to 3.15V, 3.3V, and 3.0V to satisfy the necessary power inputs to the phyCORE-LPC3250. Control logic is responsible for enabling and disabling primary system power (VCC and VCC_SDIO), while the secondary battery voltage VDS remains continuously.

Under normal operating conditions S1 will be closed and the system will be powered up. The user will initiate a sleep event by pressing the Power Button. The phyCORE-LPC3250 will detect the press of the power button and begin a sleep sequence in software preparing the system for the removal of primary power. The last step in the sleep sequence will be the phyCORE-LPC3250 signaling the Control Logic to shut down the external power supplies by opening switch S1. The only parts of the system that remain powered during a deep sleep condition are the on-board SDRAM, on-chip RTC, off-chip RTC, and sleep Control Logic. All four subsystems are powered by the 3.0V supply during a sleep event, drawing minimal power.

Once in sleep there are three different methods to wake the system and resume normal operation. These methods are: (1) an on-chip RTC alarm event via the ONSW signal or (2) an off-chip RTC alarm event via the /RTC_INT signal or (3) a user initiated wake event via the Power Button. Any three of these signals can trigger the Control Logic to reapply power to the system via closing S1. In addition to power control, the Control Logic also remembers the sleep state. Upon system reboot during a wake event the processor can check the sleep state to determine if the system should have a fresh boot or take the necessary steps to resume from a sleep condition. The Control Logic sleep state can only be cleared by either the processor, or a power fail event during sleep via the /RESET_BAT signal. In this manor should the power fail during a sleep event the processor can begin a normal boot sequence on reapplication of power due to the possibly corrupted memory data caused by the power fail condition.

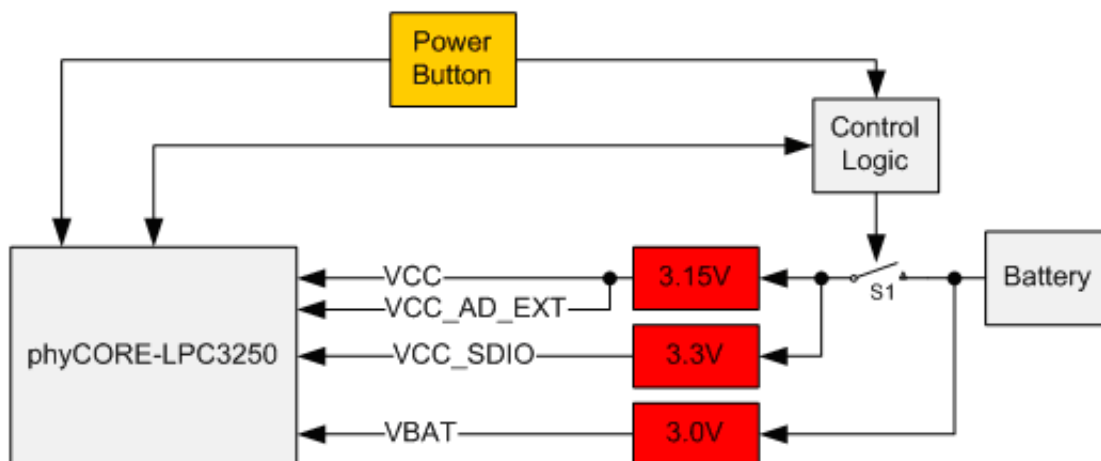

Fig. 5-1. Typical phyCORE-LPC3250 Sleep Enabled Powering Scheme

The on-board battery switch U19 is responsible for automatically powering the SDRAM and RTC subsystems from the VBAT input when VCC is lost. Under normal operating conditions (when VCC is present) the RTC and SDRAM domains are powered by the VCC supply. See the Texas Instruments TPS2115 battery switch datasheet for more details.

For a detailed explanation of the sleep control circuitry on the phyCORE-LPC3250 Carrier Board see [Chapter 23](#).

6 External RTC (U26)

An external RTC (RTC-8564JE) located at U26 has been provided in addition to the LPC3250 on-chip RTC. This RTC provides a secondary time keeping source, along with a secondary alarm mechanism to the processor via the /RTC_INT signal. By default the /RTC_INT signal is used on the phyCORE-LPC3250 Carrier Board to wake-up the power system during a deep sleep.

The RTC is interfaced to the processor via the I²C1 port. The default I²C address of the device is binary 1010 001x, where the 'x' bit is the read/write operation bit.

The RTC is automatically powered via the VBAT power input during a sleep condition. Jumper J32 is provided to configure the power source when the phyCORE-LPC3250 is ordered with a custom power configuration. In this configuration the on-chip RTC and SDRAM do not need to be powered during sleep, and only the external RTC is powered. This allows a reduced cost configuration with the removal of the dual switching regulator U22 and battery switch IC U19. This is also the most power efficient method of putting the system to sleep while allowing the external RTC to reawake the system at a later time. By default J32 is set to the 1+2 position, connecting the RTC power to the VCC_BATT signal, used during the more complex sleep mode that keeps the on-chip RTC and SDRAM alive. Alternatively this jumper can be set to the 2+3 position for the ultra low power sleep mode where U22 and U19 are removed.

7 External Watchdog

An external Maxim MAX6301 watchdog located at U18 has been provided as a processor independent means of system recovery in the event of a lockup. By default the watchdog is disabled. To enable the watchdog circuit the WDI input at the phyCORE-Connector (see [Table 2-1](#)) must be taken out of Hi-Z.

When the phyCORE-LPC3250 SOM is mounted on the phyCORE-LPC3250 Carrier Board the watchdog can be taken out of Hi-Z by closing an applicable jumper. See the phyCORE-LPC3250 Carrier Board [Chapter 38](#) for details on the jumper and associated settings. When closed processor signal GPO_20 is connected to the WDI input of the watchdog circuit. Since GPO_20 is a push-pull output of the processor, this connection effectively takes the WDI input out of Hi-Z and enables the watchdog. After the watchdog's internal timer expires the open collector /RES output of the IC is pulled LOW. Jumper J19 connects the watchdog IC's /RES output to either the /RESET_SYS signal, or the /RESET_BAT signal. By default J19 is set to the 2+3 position, connecting the /RES output to the /RESET_SYS signal. Alternatively this jumper can be set to the 1+2 position, connecting the /RES output to the /RESET_BAT signal.

Once enabled the watchdog WDI input must be toggled before the internal timeout period expires to prevent the /RES output from going active. The nominal watchdog timeout period is set to 6 seconds and can be adjusted down to 12 milliseconds by closing jumper J17. Leave J17 open to keep the watchdog timeout period at 6 seconds.

The WDI input does not need to be pulsed with a HIGH or LOW going pulse, but instead the WDI input just needs to change states before the timeout period expires.

Typically the processor will use an available timer interrupt to change the state of the WDI input (via GPO_20 when used on the phyCORE-LPC3250 Carrier Board) before the watchdog timeout period expires. In this manor should the processor lock up, the WDI input will no longer be toggled, the watchdog timeout period will expire, and the watchdog will assert the /RES output causing a system reset restoring processor operation.

8 System Configuration and Booting

For operation of the phyCORE-LPC3250 several parts of the system should be initialized. Although very little initialization needs to take place for the most basic operation, it is typical that the following interfaces will be initialized:

1. Clocking and power
2. SDRAM
3. Boot map

Clocking and Power

After a reboot the processor is operating off of the main crystal at 13.0MHz. While sufficient for small applications, it is most likely that at some point the need for full processor frequency will arise. To initialize the primary clocking and power control the following registers must be set:

1. HCLKDIV_CTRL
2. HCLKPLL_CTRL
3. PWR_CTRL

Please refer to the "Clocking and Power Control" chapter of the NXP Semiconductors LPC3250 hardware manual for details on setting these registers. Additionally you may refer to the example code provided on the PHYTEC Spectrum CD.

SDRAM

After a reboot the SDRAM interface is reset and must be initialized. The initialization procedure involves initializing two primary interfaces: 1) the LPC3250 SDRAM controller, and 2) the SDRAM itself. Initialization of the LPC3250 SDRAM controller sets up the processor with the proper timing and size configuration values required to interface the external SDRAM. The initialization of the SDRAM sets up the "mode" and "extended mode" registers on the SDRAM with information such as burst length, burst type, CAS latency, driver strength, etc... Example SDRAM initialization is code provided on the PHYTEC Spectrum CD.

Boot Map

By default after a reboot the LPC3250 on-chip boot ROM is mapped to address 0x0000 0000 and internal RAM (IRAM) is mapped to 0x0800 0000. The BOOT_MAP register controls remapping the IRAM to address 0x0000 0000. Remapping of IRAM is required for interrupts to function correctly. The beginning of IRAM is reserved for the interrupt vector table, and without proper remapping an interrupt will cause the processor to jump to the on-chip boot ROM. Therefore one of the very first initialization steps should be to set this register to 1 to remap IRAM to 0x0000 0000.

8.1 Boot Process and Boot Modes

The boot process for the LPC3250 is a multi-staged effort involving one or more boot loaders. At the very least after a reset the LPC3250 on-chip boot ROM will execute either (1) the UART5 boot mode, or (2) the normal boot mode. The boot mode is controlled by strapping the SERVICE_N signal of the processor HIGH or LOW after a reset. On the phyCORE-LPC3250 this signal is labeled as /SERVICE. An on-board pull-up resistor pulls this signal HIGH. However, when installed on the phyCORE-LPC3250 Carrier Board the default boot configuration jumper connects the /SERVICE signal to GND.

In boot mode (1) the boot ROM attempts to boot code loaded over UART5 with a simple boot protocol. In boot mode (2) the boot ROM first attempts to boot from the SPI port, followed by the external memory bus, and finally from NAND Flash. Details of the boot protocol for each bootable source can be found in the LPC3250 User's Manual.

The most typical boot configuration will boot from NAND Flash. In this boot mode the boot ROM attempts to copy boot code from block 0 or block 1 (block 1 if block 0 is bad) into IRAM and executes it. Since the boot ROM can only copy code from block 0 or block 1, this limits the size of the secondary boot loader to be constricted to stay within a single block in NAND Flash. For the phyCORE-LPC3250 NAND Flash this limit is 16kBytes. In practice this is limited to 15.5kBytes for reasons which will become apparent in the sections that follow.

The secondary boot loader is responsible for loading and executing a third level boot loader or application code, depending on the complexity of the software design. For bare-metal applications the secondary boot loader will likely suffice to load and execute the application. For operating systems the secondary boot loader will likely load a more robust, feature rich boot loader such as Das U-Boot, or E-Boot.

The job of a basic secondary boot loader can be summarized as the following:

1. Initialize the Clocking and Power (bump the core up to 208MHz)
2. Initialize the SDRAM
3. Copy the remaining code from NAND Flash into SDRAM
4. Transfer execution to SDRAM

Before covering the structure of the secondary boot loader and application code in NAND Flash, a short description of the structure of the external SLC NAND Flash device used on the phyCORE-LPC3250 is presented.

The external SLC NAND Flash used on the phyCORE-LPC3250 is a "small page" device consisting of "blocks" and "pages" of data. The NAND Flash is divided into blocks which are 16kB in size. Each block consists of 32 pages which are 512 bytes in size + 16 bytes of "spare" area. The spare area is used to (1) store bad block information, and (2) store error correction data. Unlike NOR Flash, NAND Flash can contain "bad blocks" within the Flash device. These are blocks which 1 or more bits within the block can no longer be reliably written and read. Therefore the entire block is marked bad and should not be used. NAND Flash devices are shipped with BLOCK 0 guaranteed to be a good block. Each individual NAND device may contain 0 or more bad blocks from the manufacturer, and more bad blocks may develop over time through write/erase operations. Bad blocks in new NAND devices are marked by the manufacturer by writing a value other than 0xFF to the 6th byte of the spare area of the first page of each block. For example, if the 6th byte of the spare area of block 12, page 0 did not contain 0xFF, this would indicate it is a bad block. [Figure 8-1](#) shows a graphical representation of the organization of the NAND Flash structure.

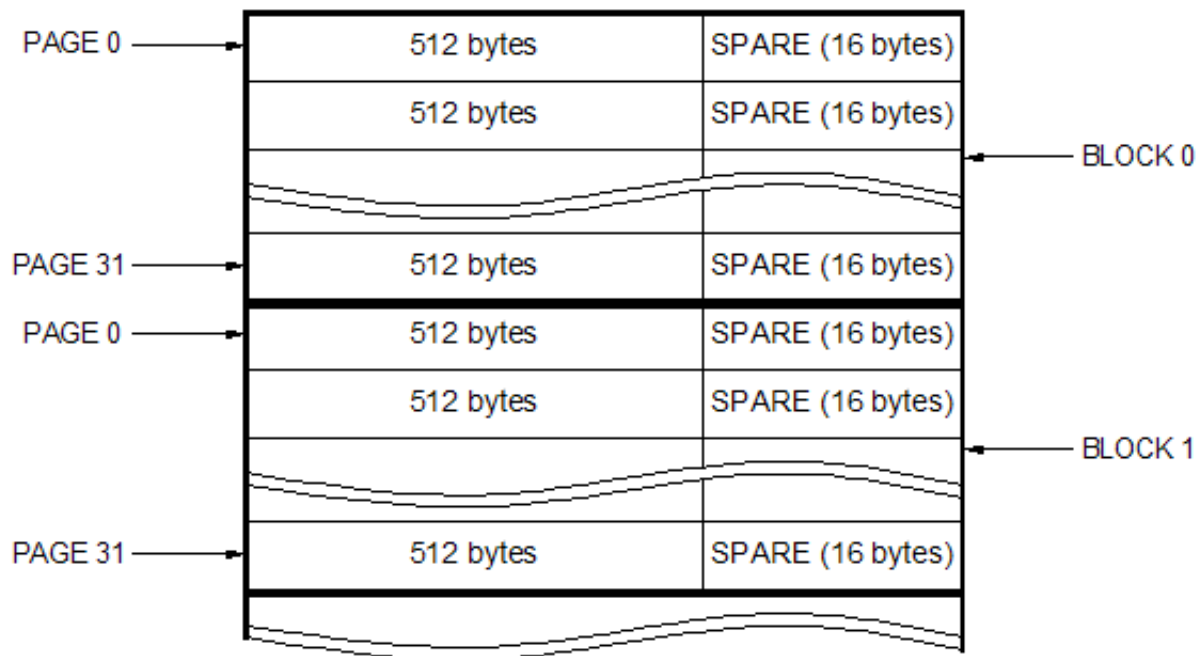

Fig. 8-1. Small Page SLC NAND Flash Structure

In addition to the spare area being used to mark bad blocks, it is also used by the LPC3250 NAND Flash controllers to store error correction code (ECC) data. With this technique an integrity check between the data within the page and the ECC can be made to determine if the data is good (given that bad blocks can develop over time).

Now that a better understanding of the NAND structure has been presented a detailing of the code structure which resides in NAND Flash can be presented.

The code in NAND Flash will have one of three structures: (1) application that is 15.5kB in size or less, (2) boot loader + application that is 256kB in size or less, or (3) boot loader + application that exceeds 256kB in size.

In (1) the code is small enough to fit and execute in IRAM and remains in block 0. It must fit in block 0 because the LPC3250 boot loader ROM will only load data from block 0.

In (2) the code exceeds block 0 in size and must occupy more NAND Flash. In this case a secondary boot loader is needed to load the application code beyond block 0 into IRAM and execute it. The secondary boot loader is placed in block 0. The application is placed in block 1 or beyond.

In (3) the code exceeds IRAM size and must be placed in SDRAM. In this case a secondary boot loader is placed in block 0 and is responsible for initializing SDRAM, loading the application code beyond block 0 into SDRAM, and then transferring execution to SDRAM.

In all three instances above block 0 page 0 always contains special data. It is for this reason that the boot loader is restricted to 15.5kB in size instead of 16kB. The block 0/page 0 data consists of the ICR, size information, and block 0 bad block information. This information is needed by the LPC3250 boot ROM to find out what type of NAND Flash the controller will be interfacing, how much code to copy from NAND

Flash into IRAM, and if this block is a bad block and the boot information is contained in block 1 instead. See the NXP Semiconductors LPC3250 hardware manual for a detailed explanation of the required data in block 0 page 0 of the NAND Flash.

Typically applications will require (3) above. In this case the boot process becomes:

1. The controller is reset.
2. The LPC3250 boot loader ROM executes and loads the secondary boot loader code located in block 0 of the NAND Flash into IRAM and transfers execution to it.
3. The secondary boot loader initializes the clocks and SDRAM.
4. The secondary boot loader copies the application code from NAND Flash starting at block 1 (or beyond) into SDRAM and transfers execution to it.

At this point the primary application is running. For most applications not involving an operating system this is all that is needed. It is possible that this application could be yet another boot loader that is responsible for booting an operating system such as Linux or WinCE.

To simplify and enhance the boot process the phyCORE-LPC3250 comes pre-flashed with a special boot loader written by NXP. This boot loader, called the "Stage 1 Loader" is discussed in more detail in the follow section.

8.1 Stage 1 Loader

The Stage 1 Loader (S1L) is a robust third level boot loader written by NXP Semiconductor to simplify and enhance the LPC3250 booting procedure. The S1L is feature rich with the ability to configure clocking, virtual memory mapping, data and instruction caches, the ability to access NAND flash, and the ability to boot applications/images from the NAND flash, SD Card, or serial port to name a few of the features the S1L provides.

In general the S1L is used to execute applications or, a 4th level boot loader such as Das U-Boot or E-Boot. The PHYTEC Rapid Development Kit comes with a pre-loaded SD Card containing demo applications, a Windows CE image, and a Linux image to easy facilitate the evaluation of each operating system as well as stand alone "bare metal" applications without the need for a debugger/JTAG probe.

Kickstart Loader

As noted in the previous section the secondary boot loader residing in NAND flash must be 15.5kB in size or less in order for the LPC3250 on-chip boot ROM to successfully load and execute the image. The robust functionality that the S1L provides cannot be packed into such a small Flash footprint, and instead exceeds the 15.5kB required for a secondary boot loader on the LPC3250. To get around this limitation the S1L is loaded as 3rd level boot loader by a small, compact secondary boot loader called the Kickstart Loader. The Kickstart Loader written by NXP fits within the 15.5kB constraints of the boot ROM and is executed immediately after a processor reset (provided UART5 booting isn't enabled or successful, and SPI and EMC booting fail).

Once the Kickstart Loader is executing it relocates itself to the top 16kB of IRAM, leaving 240KB of IRAM space left (starting at address 0x0) for an application, or 3rd level boot loader. The Kickstart Loader then loads code starting at Flash block 1 into IRAM and transfers execution to it.

On the phyCORE-LPC3250 this application/3rd level boot loader is the S1L. The S1L, once executed, provides a menu/configuration interface via UART5 of the processor.

Accessing the Stage 1 Loader

To access the Stage 1 Loader connect your PC to the bottom DB-9 female RS-232 connector on the phyCORE-LPC3250 Carrier Board at connector P1. Configure a terminal communications application for 115200,8,n,1, no hardware flow control on your PC. Press the system reset button S1 on the Carrier board to force a system reset. The terminal window should begin display S1L output. Press any key to stop the auto boot procedure (if one is configured, otherwise the S1L will go to the phy3250> prompt by itself) and come to the phy3250> prompt. Type help menu to get a list of commands. For further instructions on using the S1L and executing demo applications, refer to the appropriate Quickstart guides provided on the PHYTEC Spectrum CD.

Boot Sequence

1. The boot sequence with the Kickstart Loader and Stage 1 Loader is as follows:
2. Controller is reset
3. On-chip boot ROM executes and loads the Kickstart Loader from NAND block 0 into IRAM at address 0 and executes it
4. Kickstart Loader relocates itself to the upper 16kB of IRAM
5. Kickstart Loader begins reading the NAND Flash at block 1 and loading code (in this case, the Stage 1 Loader) starting at address 0x0 in IRAM. The first page of block 1 contains the size of the code to be loaded.
6. The Kickstart transfers execution to the loaded application code (S1L) at address 0
7. The Stage 1 Loader executes and either stops at the S1L prompt, or continues to boot from the terminal interface, SD card, or NAND flash depending on the auto boot configuration.

Where To Find More Information

In addition to the help menus NXP has published a document detailing the Kickstart Loader and the Stage 1 Loader. Please refer to this document, located on your PHYTEC Spectrum CD in *PHYTEC\phyCORE-LPC3250\Documentation\Stage1 Loader*, for more information regarding these boot loaders.

9 System Memory

The phyCORE-LPC3250 provides four types of on-board memory:

1. SDR SDRAM (U10/U11): from 16MB to 128MB
2. NOR Flash (U12/U13): from 1MB to 8MB
3. NAND Flash (U8): from 16MB to 128MB
4. EEPROM (U9): from 1KB to 32KB

The following sections of this chapter detail each memory type used on the phyCORE-LPC3250 SOM.

9.1 SDRAM (U10, U11)

The phyCORE-LPC3250 comes pre-configured with 16, 32 or 64MB of 133MHz SDR SDRAM configured for 32-bit access using two 16-bit wide RAM chips at U10 and U11.

The LPC3250 is capable of addressing a single RAM bank located at memory address 0x8000 0000 and extending to 0x9FFF FFFF via the /DYCS0 signal. It should be noted that this is beyond what the phyCORE-LPC3250 supplies for on-board memory. Refer to [Table 9-1](#) for permissible SDRAM memory access ranges.

Table 9-1. Valid SDRAM Memory Address Ranges

| SDRAM Size | Lower Memory Address | Upper Memory Address |
|-------------|----------------------|----------------------|
| 16MB | 0x8000 0000 | 0x80FF FFFF |
| 32MB | 0x8000 0000 | 0x81FF FFFF |
| 64MB | 0x8000 0000 | 0x83FF FFFF |
| 128MB | 0x8000 0000 | 0x87FF FFFF |

The second SDRAM memory bank located on /DYSC1 is not used on the phyCORE-LPC3250. Accesses to this region of memory should not be performed.

9.2 NAND Flash (U8)

The NAND memory is comprised of a single 16MB to 128MB chip located at U8 and is interfaced via the LPC3250 NAND memory bus. Write protection control of the NAND device is configurable via jumper J5. [Table 9-2](#) lists the various NAND Flash write protection control options, including the default setting on the kit version of the phyCORE-LPC3250 SOM.

Table 9-2. NAND Flash Write Protection via Jumper J5

| J | Type | Setting | Description |
|----|------|------------|--|
| J5 | 0R | 1+2 | NAND Flash write protected during power-up, power-fail, and power-down events by the controller /RESOUT signal. Use this setting to protect your flash from accidental writes/erases during power interrupt events if software control over write protect is not needed. |
| | | 2+3 | NAND Flash permanently write protected. Use this setting if your NAND flash is pre-programmed and you wish to prevent write/erase access to the flash. |
| | | 2+4 | NAND Flash write protection controlled via GPO_19. Use this setting for software controlled write protection. |
| | | Open | NAND Flash permanently write enabled. Use this setting if you wish to permanently have write access to the device. |

Refer to the NXP Common Driver Library (CDL) provided on the PHYTEC Spectrum CD for code examples for accessing the NAND Flash.

It should be noted that the NAND Flash has a dedicated memory bus on the LPC3250 to the NAND device. The NAND Flash signals are therefore not made available at the phyCORE-Connector X2.

9.3 NOR Flash (U12, U13)

The phyCORE-LPC3250 comes pre-configured with 1 to 8MB of NOR Flash configured for 32-bit access using two 16-bit wide Flash chips at U12 and U13. The NOR Flash chips occupy the first external memory bank located on chip select 0 (/CS0), and are interfaced to the processor over the buffered external memory bus. [Table 9-3](#) provides a list of valid memory ranges for varying NOR Flash densities.

Table 9-3. Valid NOR Flash Memory Address Ranges

| Flash Size | Lower Memory Address | Upper Memory Address |
|------------|----------------------|----------------------|
| 1MB | 0xE000 0000 | 0xE00F FFFF |
| 2MB | 0xE000 0000 | 0xE01F FFFF |
| 4MB | 0xE000 0000 | 0xE03F FFFF |
| 8MB | 0xE000 0000 | 0xE07F FFFF |

The NOR Flash is automatically write protected during power-up, power-fail, and power-down events with the /RESET_EMB signal connected to the flash reset (/RP) input. In addition a /FLASH_WP signal is extended out to the phyCORE-Connector X2-18C and connects to the flash write protect input (/WP). This signal has an on-board 10k pull-up resistor. Pull this signal down to ground using an open-drain/open-collector output to write protect the device. This feature may be useful if software write protection is desired.

The NOR Flash devices populating the default phyCORE-LPC3250 configuration operate at 3.15V. If desired, low power 1.8V NOR Flash can also populate the board. In this configuration the buffered memory bus voltage select must be set for 1.8V. All other devices connected to the external memory bus must also support 1.8V. See [Chapter 13](#) to configure the buffered memory bus voltage.

9.4 NOR vs. NAND

Typically both NOR and NAND Flash are not needed in the end system. The system designer will choose between one or the other. NAND Flash provides high densities and low cost per bit, but suffers from bad blocks and slower access times. NOR Flash provides fast access times, execute-in-place functionality, and error free sectors, but suffers from a higher cost per bit. It is up to the system designer to decide which characteristics are important for the system at hand. In addition the system designer should consider the total flash size requirement. Although the cost per bit is more for NOR flash it could very well be that the system requires only 2MB of flash, in which 2MB of NOR may be cheaper than the required minimum 16MB of NAND.

9.5 EEPROM (U9)

The phyCORE-LPC3250 comes pre-configured with a 32kByte SPI EEPROM located at U9 and is connected to the LPC3250 SSP port 0. By default the EEPROM stores board configuration information and the Ethernet MAC ID starting at 256 bytes from the end of the EEPROM (0x7f00). The data is stored in the following configuration struct:

```
typedef struct {
    UINT32    dramcfg;
    UINT32    syscfg;
```

```

        UINT32    mac_id[8];
        UINT32    rsvd[5];
        UINT32    fieldvval;
    } PHY_HW_T;

```

[Table 9-4](#) and [Table 9-5](#) detail the format of the `dramcfg` and `syscfg` fields in the configuration struct. The MAC ID field uses the first 6 bytes in the 8 byte `mac_id` field for the Ethernet MAC ID. Lastly the `fieldvval` must be set to 0x000a3250. This field provides a signature that the Stage 1 boot loader checks to determine if the contents of the EEPROM configuration struct are intact.

Table 9-4. EEPROM Configuration Struct *dramcfg* Field Format

| Bit | Value | Description |
|-------|-------|---------------------------------------|
| 1..0 | 00 | Low power SDRAM |
| 1..0 | 01 | SDRAM |
| 1..0 | 1x | Reserved |
| 4..2 | 000 | SDRAM 16M, 16 bits x 2 devices, 0xa5 |
| 4..2 | 001 | SDRAM 32M, 16 bits x 2 devices, 0xa9 |
| 4..2 | 010 | SDRAM 64M, 16 bits x 2 devices, 0xad |
| 4..2 | 011 | SDRAM 128M, 16 bits x 2 devices, 0xb1 |
| 31..5 | 0 | Reserved |

Table 9-5. EEPROM Configuration Struct *syscfg* Field Format

| Bit | Value | Description |
|-------|-------|-----------------------------|
| 0 | 0 | SDIO Controller unpopulated |
| 0 | 1 | SDIO Controller populated |
| 31..1 | 0 | Reserved |

The remaining space within the EEPROM is free for custom use or can be used to store a boot loader. See [Chapter 8](#) for details on booting from EEPROM.

In the event the SPI EEPROM is not needed and the SSP0 port is required for external use with some other device, jumper J16 is provided to disconnect the SSP select signal SSEL0 from the EEPROM chip select input. This jumper is provided as a convenience for prototyping. Custom SOM configurations can be ordered which simply remove the EEPROM if not needed (instead of opening J16), reducing system costs.

Jumper J31 is provided to control the EEPROM write protect input. By default this jumper is set to the 1+2 position, allowing unrestricted write operations. Set this jumper to the 2+3 position to maintain control over write protection. In addition to this jumper particular internal EEPROM status register bits must be configured to enable full write protection. See the Atmel AT25256AN datasheet for details.

9.6 Memory Map

The phyCORE-LPC3250 memory map is summarized in [Table 9-6](#) below. Make note of the memory addresses assigned to functions on the phyCORE-LPC3250. Namely these are the SDIO controller, NOR Flash, and SDRAM.

Table 9-6. phyCORE-LPC3250 Memory Map

| Address | Function |
|---------------------------|--|
| 0xE400 0000 - 0xFFFF FFFF | Reserved |
| 0xE300 0000 - 0xE3FF FFFF | External memory busy chip select 3 (b_/CS3) |
| 0xE200 0000 - 0xE2FF FFFF | External memory busy chip select 2 (b_/CS2) |
| 0xE100 0000 - 0xE1FF FFFF | External memory busy chip select 1 (b_/CS1) - used by the on-board SDIO controller |
| 0xE000 0000 - 0xE0FF FFFF | External memory busy chip select 0 (b_/CS0) - used by the on-board NOR Flash |
| 0xC000 0000 - 0xDFFF FFFF | Reserved |
| 0xA000 0000 - 0xBFFF FFFF | External memory bus SDRAM chip select 1 (/DYCS1) - not used on the phyCORE-LPC3250 and not available for external use |
| 0x8000 0000 - 0x9FFF FFFF | External memory bus SDRAM chip select 0 (/DYCS0) - used by the on-board SDRAM |
| 0x4001 0000 - 0x7FFF FFFF | Reserved |
| 0x4008 0000 - 0x400F FFFF | APB peripherals |
| 0x4000 0000 - 0x4007 FFFF | FAB peripherals |
| 0x3200 0000 - 0x3FFF FFFF | Reserved |
| 0x3000 0000 - 0x31FF FFFF | AHB peripherals |
| 0x200C 0000 - 0x2FFF FFFF | Reserved |
| 0x200A 0000 - 0x200B FFFF | AHB peripherals |
| 0x2008 0000 - 0x2009 FFFF | APB peripherals |
| 0x2000 0000 - 0x2007 FFFF | AHB peripherals |
| 0x1000 0000 - 0x1FFF FFFF | Reserved |
| 0x0C00 0000 - 0x0FFF FFFF | IROM |
| 0x0800 0000 - 0x0BFF FFFF | IRAM |
| 0x0400 0000 - 0x07FF FFFF | Dummy for DMA garbage |
| 0x0000 0000 - 0x03FF FFFF | IROM or IRAM (see BOOT_MAP register) |

10 Serial Interfaces

The phyCORE-LPC3250 provides on-board transceivers for three serial interfaces:

1. A high speed RS-232 transceiver supporting 920kbps on UART1 and 460kbps on UART5.
2. A full speed USB OTG transceiver supporting the LPC3250 USB OTG interface.
3. An Auto-MDIX enabled 10/100 Ethernet PHY supporting the LPC3250 Ethernet MAC.

The following sections of this chapter detail each of these serial interfaces and any applicable configuration jumpers.

10.1 RS-232 Transceiver (U25)

An ADM3307E RS-232 transceiver supporting typical data rates of 920kbps populates the phyCORE-LPC3250 at U25. This device provides RS-232 level translation for UARTs U5 and U1. U1 is a high speed UARTs supporting maximum data rates of 920kbps, while U5 is a standard speed UART supporting maximum data rates of 460kbps. [Table 10-1](#) details the TTL and RS-232 level signals for both UARTs. See the pin description listing in [Chapter 2, Table 2-1](#) for the signal locations on the phyCORE-Connector X2.

Table 10-1. UART 1/UART 5 TTL and RS-232 Level Signals

| UART | TTL Level Signal | RS-232 Level Signal |
|--------|------------------|---------------------|
| UART 1 | U1_TX | U1_TX_RS232 |
| | U1_RX | U1_RX_RS232 |
| UART 5 | U5_TX | U5_TX_RS232 |
| | U5_RX | U5_RX_RS232 |

In addition to RS-232 level translation, two control signals are provided for increased transceiver control. The /RS232_EN and RS232_SD signals provide enable and shutdown control. Both signals have internal 100k pull-down resistors. Drive the /RS232_EN signal HIGH (3.15V) to put the transmitter outputs into a high impedance state. Drive the RS232_SD signal HIGH (3.15V) to shut down the device and reduce power consumption to a mere 66nW. Refer to the Analog Devices ADM3307E datasheet for details on these transceiver inputs (/EN and SD). See the pin description listing in [Chapter 2, Table 2-1](#) for the signal locations on the phyCORE-Connector X2.

For custom configurations which do not require RS-232 level translation, the RS-232 transceiver U25 can be removed and 0 Ohm resistor network RN40 can be populated. In this configuration there is a direct short between the TTL level signal name and RS-232 level signal name, leaving the RS-232 level signal names operating at TTL levels.

10.2 Ethernet PHY (U6)

The phyCORE-LPC3250 comes populated with an SSMC LAN8700I Ethernet PHY at U6 supporting 10/100 Mbps Ethernet connectivity. The PHY uses an RMII interface to the Ethernet MAC integrated on the LPC3250.

The LAN8700I supports the HP Auto-MDIX function eliminating the need for consideration of a direct connect LAN cable, or a cross-over patch cable. The LAN8700I detects the TX and RX pins of the connected device and automatically configures the PHY TX and RX pins accordingly.

Interfacing the Ethernet port involves adding an RJ45 and appropriate magnetic devices in your design. Please consult the phyCORE-LPC3250 Carrier Board schematics as a reference.

If your design does not require the Ethernet interface, but does require the keyboard interface, special board alternations must be made to accommodate this. Due to pin multiplexing the Ethernet and keyboard interfaces are not simultaneously operational. Instead, either Ethernet can be used, or Keyboard, but not both.

To configure the SOM for keyboard use the following 0402 SMT resistors must be removed: R20, R21, R22, R23, R24, R126. In addition the Ethernet clock oscillator must be disabled by driving the ENET_CLKEN signal LOW. This can be accomplished by installing the applicable jumper on the phyCORE-LPC3250 Carrier Board. See [Chapter 25](#) for details on this jumper and its configuration. See [Figure 10-1](#) for the location of the resistors that must be removed for keyboard operation.

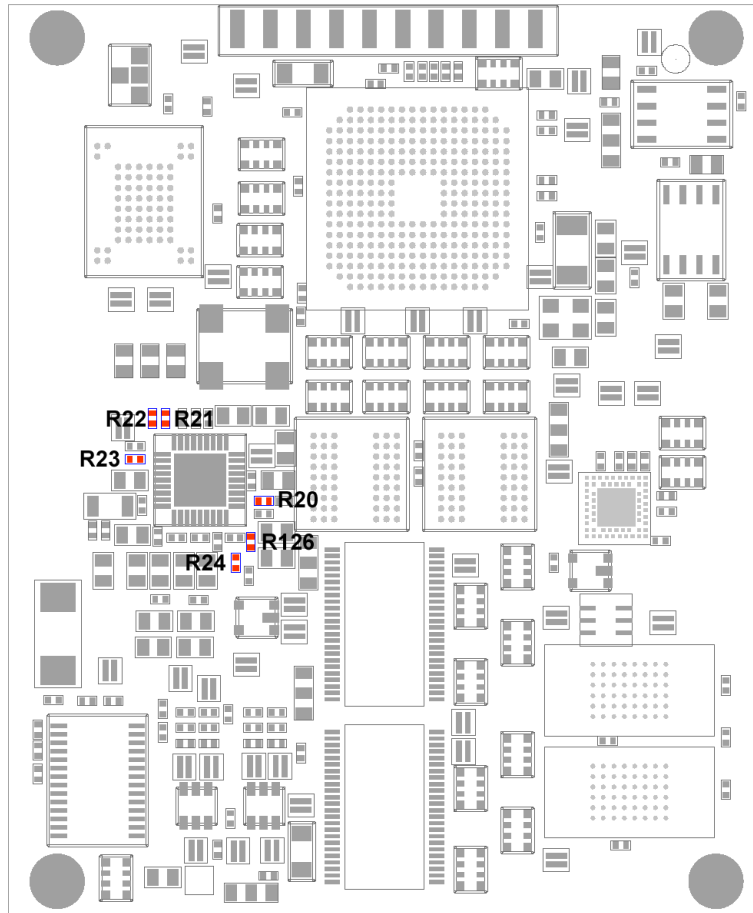

Fig. 10-1. Ethernet PHY Disconnection Resistors

10.2.1 Configuring the PHY Operating Mode (J7, J8, J9)

The LAN8700I operating mode is set via the 0R solder jumpers J7, J8, and J9. By default the PHY operating mode is set to “All capable. Auto-negotiation enabled.” If a different operating mode is required J7, J8, and J9 can be set according to [Table 10-2](#) below. J7 sets MODE0, J8 sets MODE1, and J9 sets

MODE2. By default these signals are driven to "1" via weak internal pull-up resistors on the PHY. To set a mode bit to "0" the corresponding jumper should be closed with a 10k-Ohm resistor. Refer to the SMSC LAN8700I datasheet for a detailed presentation of the PHY operating modes.

Table 10-2. Ethernet PHY Operating Mode Selection

| MODE[2:0] | J9 | J8 | J7 | Description |
|------------------|-------------|-------------|-------------|--|
| 000 | closed | closed | closed | 10Base-T Half Duplex. Auto-negotiation disabled. |
| 001 | closed | closed | open | 10Base-T Full Duplex. Auto-negotiation disabled. |
| 010 | closed | open | closed | 100Base-TX Half Duplex. Auto-negotiation disabled. CRS is active during Transmit & Receive. |
| 011 | closed | open | open | 100Base-TX Full Duplex. Auto-negotiation disabled. CRS is active during Receive. |
| 100 | open | closed | closed | 100Base-TX Half Duplex is advertised. Auto-negotiation enabled. CRS is active during Transmit & Receive. |
| 101 | open | closed | open | Repeater mode. Auto-negotiation enabled. 100Base-TX Half Duplex is advertised. CRS is active during Receive. |
| 110 | open | open | closed | Power Down mode. In this mode the PHY wake-up in Power-Down mode. |
| 111 | open | open | open | All capable. Auto-negotiation enabled. |

10.3 USB OTG Transceiver (U24)

The phyCORE-LPC3250 comes populated with an NXP Semiconductors ISP1301 USB On-The-Go transceiver supporting both full speed and low speed data rates at U24. The ISP1301 functions as the transceiver between the LPC3250 Host Controller, Device/Peripheral Controller, and On-The-Go Controller. All three controllers interface the same set of USB port pins. The USB port can be configured as a dedicated host, dedicated peripheral, or OTG interface.

When designing your USB interface you should pay special attention to current requirements when operating as an embedded host. By default an embedded USB OTG host only needs to supply 8mA of current to a connecting peripheral. The ISP1301 is capable of supplying at least 8mA to a connecting peripheral, but unless the connecting peripheral is OTG compliant it will likely have a higher current requirement. To meet this higher current requirement the USB_ADR/PSW pin can be made use of.

The USB_ADR/PSW pin both latches the lower I²C address bit of the ISP1301 and can be used to drive an external power control switch capable of sourcing additional power. In this configuration the USB_ADR/PSW signal is connected to the power supply enable input pin and the USB_VBUS signal is connected to the 5V power supply output. See the phyCORE-LPC3250 Carrier Board schematics for reference circuitry that makes use of the USB_ADR/PSW pin to provide additional host current. The USB_ADR/PSW pin is pulled-down on the SOM by default. The resulting I²C address becomes: 0101 100x, where X is the R/W bit in the I²C protocol specification.

Termination resistors and capacitors have already been populated on the phyCORE-LPC3250. A USB_VBUS capacitor of 4.7μF in parallel with a 0.1μF capacitor has also been placed on the phyCORE-LPC3250. It should be noted that the maximum VBUS capacitance a USB OTG device can add to the bus is 6.5μF. Therefore, adding anything more than 1.7μF external to the phyCORE-LPC3250 on USB_VBUS is not recommended when operating in OTG mode. This maybe increased to the typical 120uF minimum required by the USB specifications for dedicated host devices if OTG mode is not required.

In addition to optional power control circuitry via the USB_ADR/PSW signal, an external USB connector is all that is needed to interface the phyCORE-LPC3250 USB functionality. [Table 10-3](#) details applicable connectors for various end application operating modes. The applicable interface signals (USB_D+/USB_D-/USB_VBUS/USB_ID/USB_ADR/PSW) can be found in the phyCORE-connector pin-out [Table 2-1](#).

Table 10-3. Applicable USB Operating Mode Connectors

| Operating Mode | Applicable Connectors |
|-----------------------|------------------------------|
| Host | Standard-A |
| | Mini-A |
| Device/Peripheral | Standard-B |
| | Mini-B |
| OTG | Mini-AB |

11 SDIO Controller (U14)

The phyCORE-LPC3250 comes populated with the NXP SDIO101 SD/SDIO/MMC/CE-ATA compliant host controller at U14. The SDIO controller provides the hardware compliant layer to SD, SDIO, MMC, and CE-ATA enabled devices.

The SDIO controller is interfaced to the LPC3250 via the buffered external memory bus. [Table 11-1](#) provides a detailed summary of the processor signals connected to the SDIO controller.

Table 11-1. SDIO Controller to LPC3250 Signal Mapping

| SDIO Controller Signal | LPC3250 Signal | phyCORE-LPC3250 Signal |
|------------------------|----------------|------------------------|
| D15 | EMC_D15 | b_D15 |
| D14 | EMC_D14 | b_D14 |
| D13 | EMC_D13 | b_D13 |
| D12 | EMC_D12 | b_D12 |
| D11 | EMC_D11 | b_D11 |
| D10 | EMC_D10 | b_D10 |
| D9 | EMC_D9 | b_D9 |
| D8 | EMC_D8 | b_D8 |
| D7 | EMC_D7 | b_D7 |
| D6 | EMC_D6 | b_D6 |
| D5 | EMC_D5 | b_D5 |
| D4 | EMC_D4 | b_D4 |
| D3 | EMC_D3 | b_D3 |
| D2 | EMC_D2 | b_D2 |
| D1 | EMC_D1 | b_D1 |
| D0 | EMC_D0 | b_D0 |
| A8 | EMC_A19 | b_A19 |
| A7 | EMC_A6 | b_A6 |
| A6 | EMC_A5 | b_A5 |
| A5 | EMC_A4 | b_A4 |
| A4 | EMC_A3 | b_A3 |
| A3 | EMC_A2 | b_A2 |
| A2 | EMC_A1 | b_A1 |
| A1 | EMC_A0 | b_A0 |
| /CS | /EMC_CS1 | b_/CS1 |
| /RE | /EMC_OE | b_/OE |
| /WE | /EMC_WR | b_/WR |
| /BE1 | GND | GND |
| /BE0 | GND | GND |
| DREQ | Not connected | Not connected |
| /INT | GPI_07/PCAP3.0 | GPI_7 |

It should be noted that the GPI_7 interrupt signal has an internal 10k pull-up on-board.

The SDIO reset signal is connected through an inverter to the phyCORE-LPC3250 /RESET_EMB signal. This will trigger a SDIO reset during power-up, power-fail, and power-down events.

The SDIO controller is clocked from the LPC3250 processor TST_CLK2 signal. This clock signal must be configured on the LPC3250 (via the TEST_CLK register) to output a frequency compatible with the SDIO controller. A good setting to use for the TEST_CLK register is either the main oscillator clock (13MHz) or PERIPH_CLK (if configured for 13MHz).

The SD/SDIO/MMC/CE-ATA interface signals are listed in [Table 11-2](#) below.

Table 11-2. SDIO Controller Interface Signals

| SDIO Controller Signal | phyCORE-LPC3250 Signal | Description |
|------------------------|------------------------|---|
| CLK | SDIO_CLK | Clock output for read/write transactions |
| CMD | SDIO_CMD | Bidirectional command transfer |
| DATA0 | SDIO_D0 | Data bus bit 0 |
| DATA1 | SDIO_D1 | Data bus bit 1 |
| DATA2 | SDIO_D2 | Data bus bit 2 |
| DATA3 | SDIO_D3 | Data bus bit 3 |
| DATA4 | SDIO_D4 | Data bus bit 4 |
| DATA5 | SDIO_D5 | Data bus bit 5 |
| DATA6 | SDIO_D6 | Data bus bit 6 |
| DATA7 | SDIO_D7 | Data bus bit 7 |
| /SDCP | /SDIO_CP | Card protect input (w/internal 100k pull-up) |
| /SDWP | /SDIO_WP | Write protect input (w/internal 100k pull-up) |
| POW0 | SDIO_POW0 | Power control output bit 0 |
| POW1 | SDIO_POW1 | Power control output bit 1 |

The SDIO controller provides a configurable voltage interface to the connecting SD/SDIO/MMC/CE-ATA device via a set of power pins available at the phyCORE-Connector X2 as VCC_SDIO. In addition two power control pins SDIO_POW0 and SDIO_POW1 are provided to control an external power supply to the power pins and switch between off, low-power, and high-power modes. The flexibility of the power interface allows a wide range of connecting devices to interface the on-board SDIO controller along with management of dynamic power consumption.

Refer to the phyCORE-Connector X2 pinout [Table 2-1](#) for signal locations. The phyCORE-LPC3250 Carrier Board schematics provide an excellent design reference for implementing a fully controllable SDIO power interface. Refer to the NXP SDIO101 datasheet for SDIO controller details.

12 Debug Interface (X1)

The phyCORE-LPC3250 is equipped with a JTAG interface for downloading program code into internal controller RAM or for debugging programs currently executing. The JTAG interface extends out to 2.54 mm pitch pin header at X1 on the edge of the module, in addition to being made available at the phyCORE-Connector X2. [Figure 12-1](#) shows the position of the debug interface (JTAG connector X1) on the phyCORE-module. Even numbered pins are on the top of the module, starting with 2 on the right to 20 on the left, while odd number pins are on the bottom, starting from (as viewed from the top) 1 on the right to 19 on the left. See [Figure 12-1](#) below for details.

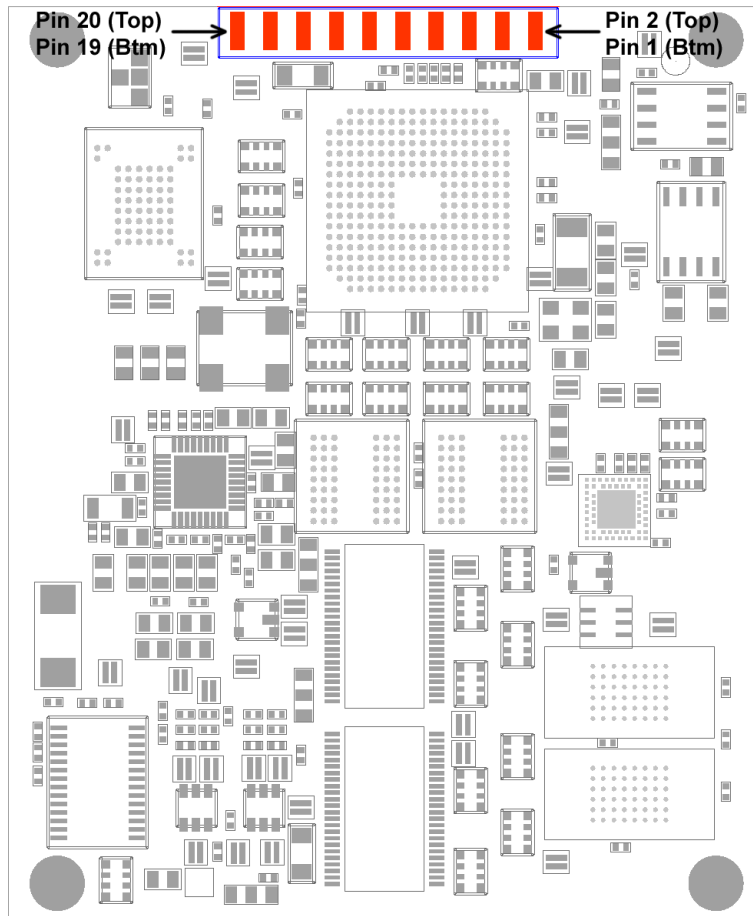

Fig. 12-1. JTAG Interface X1 (Controller Side)

The JTAG edge card connector X1 provides an easy means of debugging the phyCORE-LPC3250 in your target system via an external JTAG probe, such as the Abatron BDI2000.

NOTE:

The JTAG connector X1 only populates phyCORE-LPC3250 modules with order code PCM-040-xxxxxD. This version of the phyCORE module must be special ordered. The JTAG connector X1 is not populated on phyCORE modules included in the Rapid Development Kit. All JTAG signals are accessible from the Carrier Board. The JTAG signals are also accessible at the phyCORE-Connector X2 (Molex connectors). We recommend integration of a standard (2.54 mm pitch) pin header connector in the user target circuitry to allow easy program updates via the JTAG interface. See [Chapter 2](#) for details on the JTAG signal pin assignment.

13 Bus Buffers (U1, U2, U3, U4, U5)

The phyCORE-LPC3250 provides a buffered version of the processor's external memory bus via bus buffers U1, U2, U3, U4 and U5 for connection of external memory mapped peripherals. Data bus direction is controlled by the processor's output enable signal /OE. [Table 13-1](#) provides a detailed list of the memory bus signals available at the phyCORE-Connector X2. Refer to the phyCORE-Connector pin-out [Table 2-1](#) for signal locations.

Table 13-1. Buffered Memory Bus Signal Mapping

| LPC3250 Signal | Buffered phyCORE-LPC3250 Signal | Description |
|---------------------|---------------------------------|--|
| EMC_D31...EMC_D0 | b_D31...b_D0 | Data bus |
| EMC_A23...EMC_A0 | b_A23...b_A0 | Address bus |
| /EMC_CS3.../EMC_S0 | b_/CS3...b_/CS0 | Chip selects. Note b_/CS0 is connected to the on-board NOR flash and b_/CS1 is connected to the on-board SDIO controller. b_/CS2 and b_/CS3 are free for external use. |
| EMC_BLS3...EMC_BLS0 | b_BLS3...b_BLS0 | Byte lane selects |
| /EMC_OE | b_/OE | Output enable |
| /EMC_WR | b_/WR | Write enable |

Configuration jumpers J1, J2, J3, and J4 are provided to control the bidirectional data bus buffer output enable. By default all four jumpers are set to the 2+3 position, permanently enabling the data bus buffer outputs. Depending on the memory bus operation of the connecting device it may be desirable to have the data bus driven only during access times dictated by the byte lane select signals. This type of configuration would be used for devices that may potentially drive the data bus on the bytes which are not being currently written to. In this instance using J1-4 to drive enable the data bytes on the buffers for which the byte lane select signals are active would prevent any contention between the buffers driving the bus and the connecting device driving the bus on unaccessed bytes. This type of operation is very uncommon and will likely not be needed, but configuration jumpers are provided nonetheless.

[Table 13-2](#) provides a summary of the buffered memory map. Note that only chip select 2 and 3 are freely available on the standard phyCORE-LPC3250 configuration.

Table 13-2. Buffered Memory Bus Map

| Address | Function |
|---------------------------|---|
| 0xE300 0000 - 0xE3FF FFFF | External memory busy chip select 3 (b_/CS3) - freely available for external use |
| 0xE200 0000 - 0xE2FF FFFF | External memory busy chip select 2 (b_/CS2) - freely available for external use |
| 0xE100 0000 - 0xE1FF FFFF | External memory busy chip select 1 (b_/CS1) - used by the on-board SDIO controller |
| 0xE000 0000 - 0xE0FF FFFF | External memory busy chip select 0 (b_/CS0) - used by the on-board NOR Flash |

13.1 Buffered Memory Bus Voltage Select (J21)

The buffered memory bus operating voltage is configurable between 1.8V and 3.15V via jumper J21 to allow connection of a variety of devices. By default this jumper is set to the 2+3 position, selecting 3.15V. To interface 1.8V low power devices to the external memory bus J21 should be set to the 1+2 position.

WARNING:

The standard phyCORE-LPC3250 configuration does not allow a 1.8V external memory bus voltage. The on-board NOR flash and SDIO controller are only operable at 3.15V. The 1.8V setting should not be used unless you have specifically ordered a configuration that is compatible to 1.8V. Ordering options which are compatible with 1.8V include: (1) 3.15V NOR Flash removed, SDIO controller removed, (2) 1.8V NOR Flash populated, SDIO controller removed, or (3) NOR Flash and SDIO removed.

14 Technical Specifications

The physical dimensions of the phyCORE-LPC3250 are represented in Figure 14-1. The module's profile is approximately 7.9mm thick, with a maximum component height of approximately 3.35mm on the bottom (connector) side of the PCB and approximately 2.58mm on the top (microcontroller) side. The board itself is approximately 1.26mm thick.

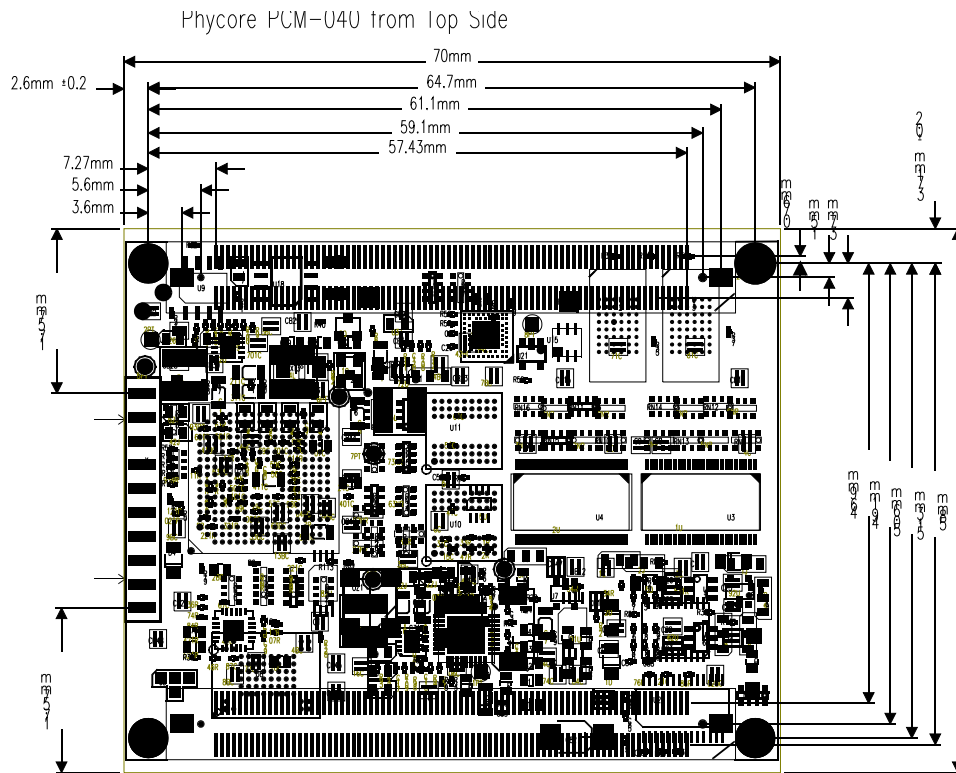

Fig. 14-1. phyCORE-LPC3250 Physical Dimensions

Table 14-1. Technical Specifications

| | |
|-----------------------|---|
| Dimensions | 70 x 58 mm |
| Weight | Approximately 25.5g with all optional components mounted on the circuit board |
| Storage Temperature | -40C to +90C |
| Operating Temperature | -40C to +85C |
| Humidity | 95% r.F. not condensed |
| Power Consumption | ~0.372W typical Operating Conditions: VCC = 3.15 V 64MB SDRAM @ 104MHz, 2 MB NOR, 64MB NAND, WinCE booted |

Table 14-2. Static Operating Characteristics^a

| Symbol | Description | Conditions | Min | Typ | Max | Unit |
|-------------------------|-------------------------------|---|------------|------------|------------|-------------|
| VCC | Primary SOM input voltage | | 3.05 | 3.15 | 3.3 | V |
| VCC_SDIO | SDIO input voltage | | 1.65 | 3.15 | 3.6 | V |
| VBAT ^b | Battery input voltage | | 2.85 | 3.0 | 3.3 | V |
| VCC_AD_EXT ^c | LPC3250 A/D input voltage | | 2.7 | 3.15 | 3.3 | V |
| ICC | Primary SOM operating current | Core @ 208MHz, 64MB SDRAM @ 104MHz, 2MB NOR, 64MB NAND, WinCE 6.0 booted, Ethernet enabled | - | 118 | - | mA |
| ICC _{SDIO} | SDIO operating current | Core @ 208MHz, 64MB SDRAM @ 104MHz, 2MB NOR, 64MB NAND | - | TBD | - | mA |
| ICC _{VBAT} | Battery operating current | Deep sleep; all SOM power removed except RTC and SDRAM; SDRAM in self- refresh | - | 255 | - | uA |
| ICC _{AD} | LPC3250 A/D operating current | Core @ 208MHz, 64MB SDRAM @ 104MHz, 2MB NOR, 64MB NAND | - | TBD | - | mA |

a. Tamb = -40C to +85C unless otherwise specified.

b. VBAT should always be less than VCC for proper operation.

c. Operating limits are per the NXP LPC3250 datasheet for the VCCA(3V0) pins.

These specifications describe the standard configuration of the phyCORE-LPC3250 as of the printing of this manual.

15 Hints for Handling the phyCORE-LPC3250

Removal of various components, such as the microcontroller and the standard quartz, is not advisable given the compact nature of the module. Should this nonetheless be necessary, please ensure that the board as well as surrounding components and sockets remain undamaged while de-soldering. Overheating the board can cause the solder pads to loosen, rendering the module inoperable. Carefully heat neighboring connections in pairs. After a few alternations, components can be removed with the solder-iron tip. Alternatively, a hot air gun can be used to heat and loosen the bonds.

16 Component Placement Diagrams

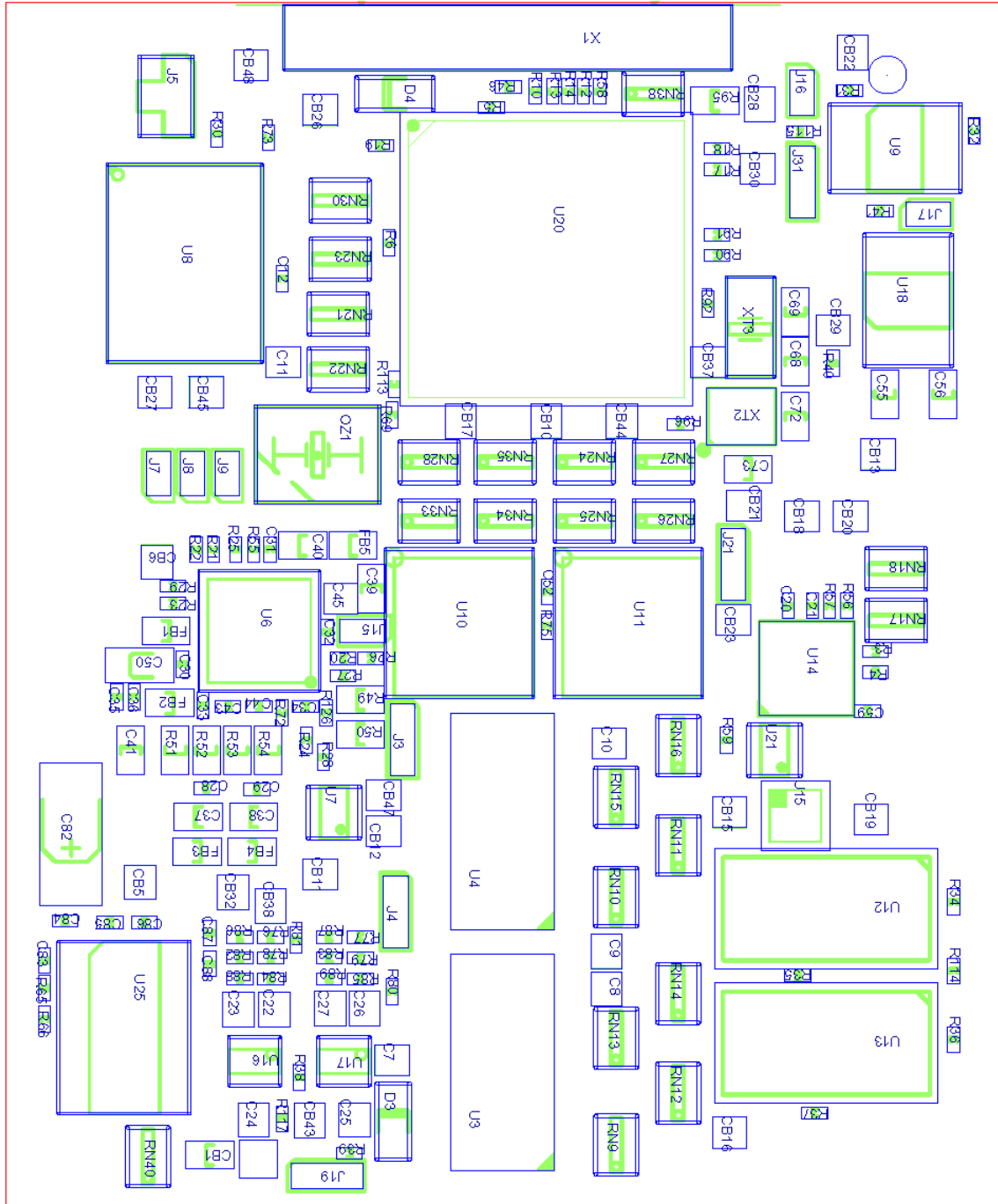

Fig. 16-1. phyCORE-LPC3250 Component Placement (Controller Side)



Fig. 16-2. phyCORE-LPC3250 Component Placement (Connector Side)

Part II: PCM-967/phyCORE-LPC3250 Carrier Board

Part 2 of this 3 part manual provides detailed information on the phyCORE-ARM9/LPC3250 Carrier Board and its usage with the phyCORE-LPC3250 SOM.

The information in the following chapters is applicable to the 1305.3 PCB revision of the phyCORE-LPC3250 Carrier Board. The information is also applicable to the 1305.2 PCB revision, with the exception of board images. All board images in this section of the manual refer to the 1305.3 PCB. Board images can be used for the 1305.2 PCB revision, with the exception of jumper JP58. Jumper JP58 is moved a short distance from the 1305.3 PCB. In all other respects the two board revisions are essentially identical.

The Carrier Board can also serve as a reference design for development of custom target hardware in which the phyCORE SOM is deployed. Carrier Board schematics with BoM are available under a Non Disclosure Agreement (NDA). Re-use of Carrier Board circuitry likewise enables users of PHYTEC SOMs to shorten time-to-market, reduce development costs, and avoid substantial design issues and risks.

17 Introduction

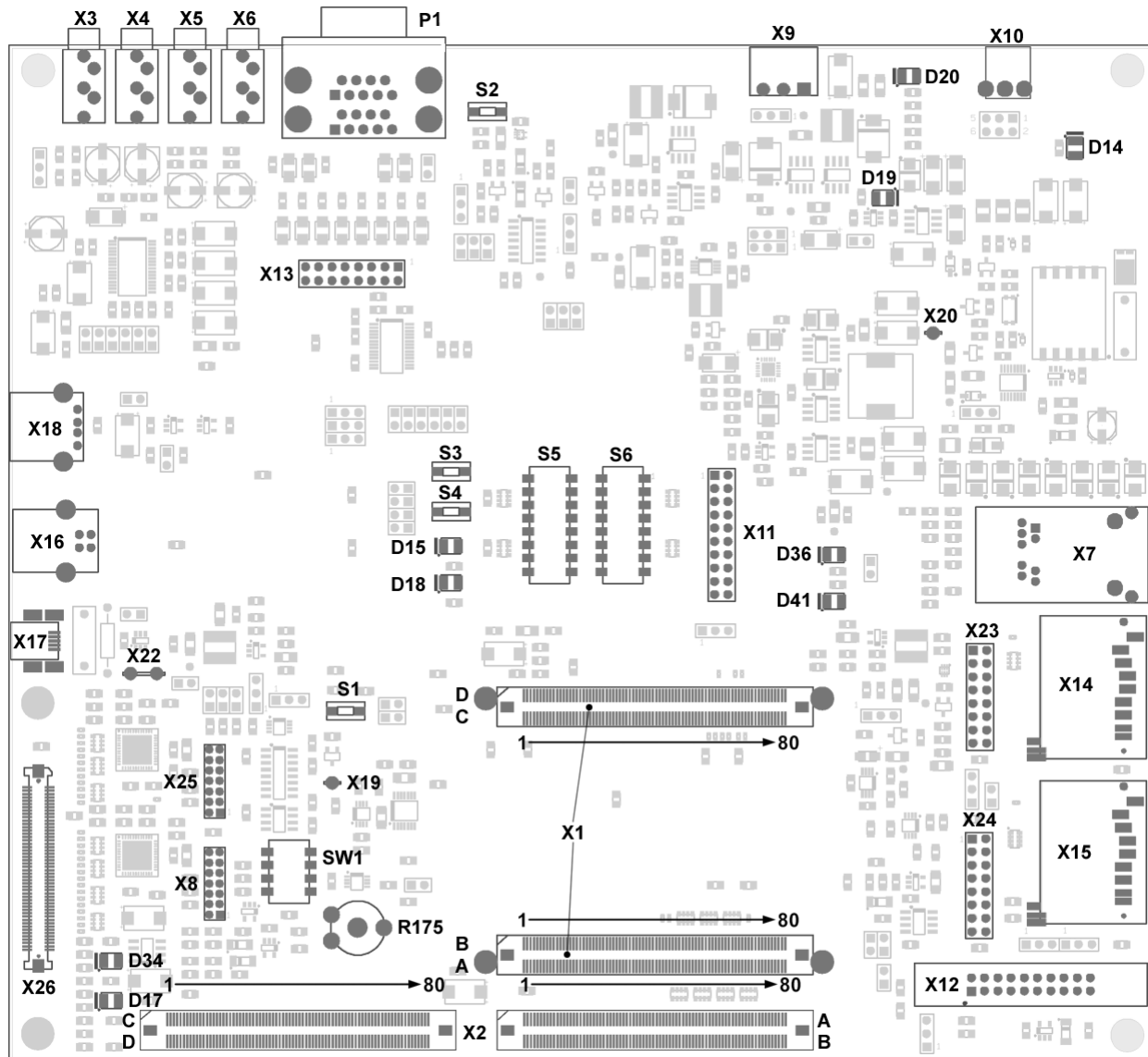

Fig. 17-1. phyCORE-LPC3250 Carrier Board Overview of Connectors and Interfaces

PHYTEC Carrier Boards are fully equipped with all mechanical and electrical components necessary for the speedy and secure start-up and subsequent communication to and programming of the applicable PHYTEC System on Module (SOM). Carrier Boards are designed for evaluation, testing and prototyping of PHYTEC SOMs in laboratory environments prior to their use in customer designed applications.

The phyCORE-LPC3250 Carrier Board provides a flexible development platform enabling quick and easy start-up and subsequent programming of the phyCORE-LPC3250 System on Module. The Carrier Board design allows easy connection of additional expansion boards featuring various functions that support fast and convenient prototyping and software evaluation.

18 Overview of Peripherals

The phyCORE-LPC3250 Carrier Board is depicted in [Figure 17-1](#) and includes the following components and peripherals listed in [Table 18-1](#), [Table 18-2](#), [Table 18-3](#) and [Table 18-4](#). For a more detailed description of each peripheral refer to the appropriate chapter listed in the applicable table.

Table 18-1. Connectors and Headers

| Ref. Des. | Description | Chapter |
|-----------|--|----------------------|
| X1 | phyCORE-Connector for phyCORE-LPC3250 SOM connectivity | 20 |
| X2 | GPIO expansion connector. Most phyCORE-LPC3250 signals are made available at this connector. | 28 |
| X3 | Audio MIC input jack for the UDA1380 audio codec | 24 |
| X4 | Audio LINE input jack for the UDA1380 audio codec | 24 |
| X5 | Audio LINE output jack for the UDA1380 audio codec | 24 |
| X6 | Audio HEADPHONE output jack for the UDA1380 audio codec | 24 |
| X7 | RJ-45 Ethernet jack for the phyCORE-LPC3250 Ethernet interface | 25 |
| X8 | LCD signal configuration CPLD JTAG programming header for U4 | 27 |
| X9 | Lithium-ion battery connector for powering the board via an external battery | 21.3 |
| X10 | Wall adapter input power jack to supply main board power | 21.1 |
| X11 | Easy access Ethernet/Keyboard signal header | 32 |
| X12 | JTAG programming header | 22 |
| X13 | Easy access UART3/UART2 signal header | 29 |
| X14 | SD card connector for the phyCORE-LPC3250 on-board SD/SDIO/MMC/CE-ATA controller | 31 |
| X15 | SD card connector for the LPC3250 SD/MMC port | 30 |
| X16 | USB peripheral connector for the phyCORE-LPC3250 USB OTG interface | 26 |
| X17 | USB OTG connector for the phyCORE-LPC3250 USB OTG interface | 26 |
| X18 | USB host connector for the phyCORE-LPC3250 USB OTG interface | 26 |
| X19 | Ground stud for easy ground connection of test equipment (e.g., oscilloscope ground clip) | N/A |
| X20 | Ground stud for easy ground connection of test equipment (e.g., oscilloscope ground clip) | N/A |
| X22 | USB and Ethernet shield ground connection access point | N/A |
| X23 | Easy access signal header for the phyCORE-LPC3250 on-board SD/SDIO/MMC/CE-ATA controller | 31 |
| X24 | Easy access signal header for the LPC3250 SD/MMC port | 30 |
| X25 | LCD signal configuration CPLD JTAG programming header for U6 | 27 |
| X26 | LCD connector for connection of an external PHYTEC LCD board | 27 |
| P1 | UART3/2 and UART5 RS-232 connector | 29 |

Table 18-2. Description of the Buttons and Switches

| Ref. Des. | Description | Chapter |
|-----------|---|---------|
| S1 | System reset button | 37 |
| S2 | Power/Sleep button | 23 |
| S3 | User button 1 (labeled BTN1) | 33 |
| S4 | User button 2 (labeled BTN2) | 33 |
| S5 | 8-position dip switch allowing keyboard ROW pull-up resistor enable/disable (1M | 32 |
| S6 | 8-position dip switch allowing keyboard COLUMN pull-up resistor enable/disable | 32 |
| SW1 | 4-position dip switch for LCD control | 27 |

Table 18-3. Description of LEDs

| Ref. Des. | Description | Chapter |
|-----------|-----------------------------------|---------|
| D14 | Power-over-Ethernet status (red) | 21.2 |
| D15 | User controlled LED 1 (red) | 34 |
| D17 | LCD 5V status (green) | 27 |
| D18 | User controlled LED 2 (green) | 34 |
| D19 | Battery charging status (red) | 21.3.1 |
| D20 | Wall adapter power status (red) | 21.1 |
| D34 | LCD 3.3V status (green) | 27 |
| D36 | Ethernet Link status (green) | 21.2 |
| D41 | Ethernet Activity status (yellow) | 21.2 |

Table 18-4. Description of Potentiometers

| Ref. Des. | Description | Chapter |
|-----------|---|---------|
| R175 | Potentiometer to test LPC3250 ADC channel 2 (ADIN2) | 35 |

Please note that all module connections are not to exceed their expressed maximum voltage or current. Maximum signal input values are indicated in the corresponding controller User's Manual/Data Sheets. As damage from improper connections varies according to use and application, it is the user's responsibility to take appropriate safety measures to ensure that the module connections are protected from overloading through connected peripherals.

19 Jumpers

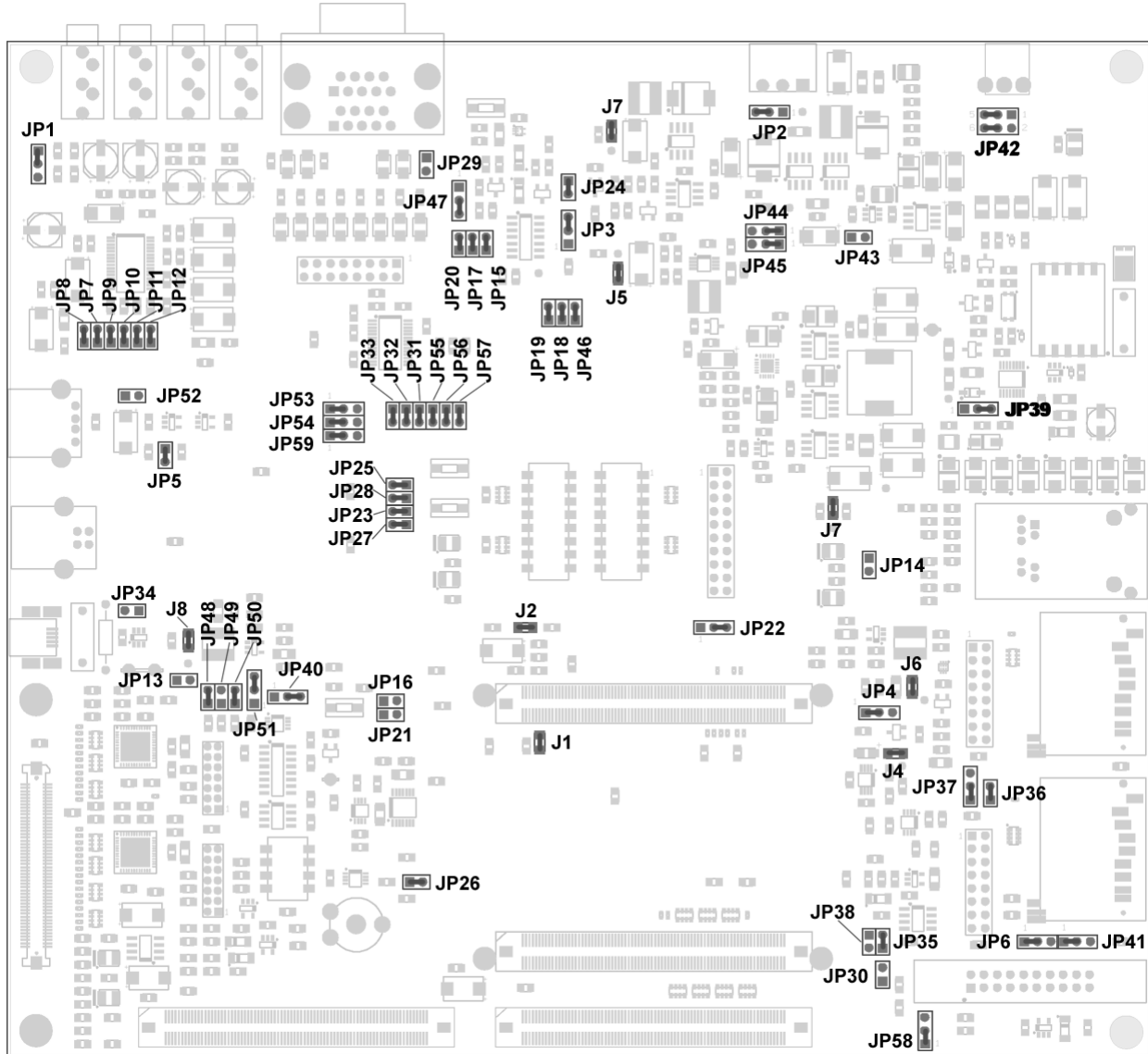

Fig. 19-1. Jumper Locations and Default Settings

The phyCORE-LPC3250 Carrier Board comes pre-configured with 51 removable jumpers (JP). The jumpers allow the user flexibility of rerouting a limited amount of signals for development constraint purposes. [Table 19-1](#) below lists the 51 removable jumpers, their default positions, and their functions in each position. [Figure 19-2](#) depicts the jumper pad numbering scheme for reference when altering jumper settings on the development board. Note that pin 1 is always marked by a square footprint in the jumper location diagrams that follow. [Figure 19-1](#) provides a detailed view of the phyCORE-LPC3250 Carrier Board jumpers and their default settings.



Fig. 19-2. Typical Jumper Pad Numbering Scheme (Removable Jumpers)

Table 19-1 provides a comprehensive list of all Carrier Board jumpers. The table only provides a concise summary of jumper descriptions. For a detailed description of each jumper see the applicable chapter listing in the right hand column of the table.

The following conventions were used in the J/JP column of the jumper table:

- J = solder jumper
- JP = removable jumper)

Table 19-1. Jumper Settings

| J/JP | Setting | Description | Chapter |
|------|---------|---|---------|
| JP1 | 1+2 | MIC bias connected to outer ring. | 24 |
| | 2+3 | MIC bias connected to inner ring. | |
| | Open | MIC bias disabled. | |
| JP2 | 1+2 | Battery charger monitors battery temperature. | 21.3.1 |
| | 2+3 | Battery charger temperature monitor disabled. | |
| JP3 | 1+2 | System is powered down after a deep sleep fault. | 23 |
| | 2+3 | System is powered up after a deep sleep fault. | |
| JP4 | 1+2 | VCC_SDIO adjustable between 1.8V and 3.15V. | 31 |
| | 2+3 | VCC_SDIO adjustable between 1.8V and 3.3V. | |
| JP5 | 1+2 | USB VBUS power not controlled during over current. | 26 |
| | 2+3 | USB VBUS power controlled by USB OTG transceiver during over current. | |
| JP6 | 1+2 | SD/MMC card slot X15 power source controlled by processor signal GPO_5 (on/off control). | 30 |
| | 2+3 | SD/MMC card slot X15 power source always on. | |
| JP7 | Open | I2STX_SDA1 signal disconnected from audio codec. | 24 |
| | Closed | I2STX_SDA1 signal connected to audio codec. | |
| JP8 | Open | I2STX_WS1 signal disconnected from audio codec. | 24 |
| | Closed | I2STX_WS1 signal connected to audio codec. | |
| JP9 | Open | I2STX_CLK1 signal disconnected from audio codec. | 24 |
| | Closed | I2STX_CLK1 signal connected to audio codec. | |
| JP10 | Open | I2SRX_SDA1 signal disconnected from audio codec. | 24 |
| | Closed | I2SRX_SDA1 signal connected to audio codec. | |
| JP11 | Open | I2SRX_WS1 signal disconnected from audio codec. | 24 |
| | Closed | I2SRX_WS1 signal connected to audio codec. | |
| JP12 | Open | I2SRX_CLK1 signal disconnected from audio codec. | 24 |
| | Closed | I2SRX_CLK1 signal connected to audio codec. | |
| JP13 | Open | Audio reset controlled by external RC circuit. | 24 |
| | Closed | Audio reset controlled by processor signal GPO_02/MAT1.0/LCD0. | |

Table 19-1. Jumper Settings (Continued)

| J/JP | Setting | Description | Chapter |
|-------------|----------------|---|----------------|
| JP14 | Open | Ethernet clocking enabled. | 25 |
| | Closed | Ethernet clocking disabled. | |
| JP15 | Open | Processor signal GPI_19 free for external use. | 23 |
| | Closed | Processor signal GPI_19 used to read deep sleep state flip-flop. | |
| JP16 | Open | NOR Flash write enabled. | N/A |
| | Closed | NOR Flash write protected. | |
| JP17 | Open | Processor signal GPO_17 free for external use. | 23 |
| | Closed | Processor signal GPO_17 used to set deep sleep state flip-flop. | |
| JP18 | Open | VCC_5V0 rail active during deep sleep. | 23 |
| | Closed | VCC_5V0 rail shuts down during deep sleep. | |
| JP19 | Open | VCC_3V15 rail active during deep sleep. | 23 |
| | Closed | VCC_3V15 rail shuts down during a deep sleep. | |
| JP20 | Open | Processor signal GPO_11 free for external use. | 23 |
| | Closed | Processor signal GPO_11 used to clear deep sleep state flip-flop. | |
| JP21 | Open | System boots from SPI/EMC/NAND Flash. | 36 |
| | Closed | System boots from UART5 followed by SPI/EMC/NAND. | |
| JP22 | 1+2 | Processor signal GPI_0/[TBD] used to read power button output. | 23 |
| | 2+3 | Processor signal GPI_0/[TBD] used to read power button output. | |
| | Open | GPI_0/[TBD] free for external use. | |
| JP23 | Open | Processor signal GPO_1 free for external use. | 34 |
| | Closed | Processor signal GPO_1 controls User LED 1 (LED1). | |
| JP24 | Open | Off-chip RTC cannot wake-up the processor during deep sleep. | 23 |
| | Closed | Off-chip RTC is capable of waking up the processor during deep sleep. | |
| JP25 | Open | Processor signal GPI_3 free for external use. | 33 |
| | Closed | Processor signal GPI_3 used to read User Button 1 (BTN1) status. | |
| JP26 | Open | Processor signal ADIN2 free for external use. | 35 |
| | Closed | Processor signal ADIN2 used to read ADC potentiometer (ADC POT) output voltage. | |
| JP27 | Open | Processor signal GPO_14 free for external use. | 34 |
| | Closed | Processor signal GPO_14 controls User LED 2 (LED2). | |
| JP28 | Open | Processor signal GPI_2 free for external use. | 33 |
| | Closed | Processor signal GPI_2 used to read User Button 2 (BTN2) status. | |
| JP29 | Open | phyCORE-LPC3250 on-board RS-232 transceiver operational. | 29 |
| | Closed | phyCORE-LPC3250 on-board RS-232 transceiver shutdown. | |
| JP30 | Open | Processor debug mode enabled. | 22 |
| | Closed | Processor boundary scan mode enabled. | |
| JP31 | Open | Processor signal U3_RTS/U2_HRTS/GPO_23 free for external use. | 29 |
| | Closed | Processor signal U3_RTS/U2_HRTS/GPO_23 routed through external RS-232 transceiver. | |
| JP32 | Open | Processor signal U3_DCD/GPI_05 free for external use. | 29 |
| | Closed | Processor signal U3_DCD/GPI_05 routed through external RS-232 transceiver. | |

Table 19-1. Jumper Settings (Continued)

| J/JP | Setting | Description | Chapter |
|-------------|----------------|---|----------------|
| JP33 | Open | Processor signal U3_RI/GPI_11 free for external use. | 29 |
| | Closed | Processor signal U3_RI/GPI_11 routed through external RS-232 transceiver. | |
| JP34 | Open | USB_ID pin forced to ground. | 26 |
| | Closed | USB_ID pin floating. | |
| JP35 | Open | Processor signal GPO_5 free for external use. | 30 |
| | Closed | Processor signal GPO_5 used as SD/MMC card power control. | |
| JP36 | Open | Processor signal GPIO_1 free for external use. | 30 |
| | Closed | Processor signal GPIO_1 used to read SD/MMC card detect status. | |
| JP37 | Open | Processor signal GPIO_0 free for external use. | 30 |
| | Closed | Processor signal GPIO_0 used to read SD/MMC write protect status. | |
| JP38 | Open | Processor signal GPO_20 free for external use. | 38 |
| | Closed | Processor signal GPO_20 used to drive the watchdog input signal. | |
| JP39 | 1+2 | PoE signature resistor disabled. | 25 |
| | 2+3 | PoE signature resistor enabled. | |
| JP40 | 1+2 | LCD interface disabled; Processor signal GPO_0 free for external use. | 27 |
| | 2+3 | LCD interface enable/disable controlled by processor signal GPO_0. | |
| | Open | LCD interface enabled; Processor signal GPO_0 free for external use. | |
| JP41 | 1+2 | JTAG /SRST circuit powered to drive the /RESET_SYS signal. | 22 |
| | 2+3 | JTAG /SRST circuit powered to drive the /RESET_BAT signal. | |
| JP42 | 4+6 | Board power is sourced via wall adapter. | 21.1 |
| | 5+3 | | |
| | 2+4 | Board power is sourced via PoE. | |
| | 1+3 | | |
| JP43 | Open | Board power is sourced by wall adapter or PoE if present, and by battery supply otherwise. | 21 |
| | Closed | Board power is forced to wall adapter or PoE. | |
| JP44 | 1+2 | 3.15V supply generated from VCC_IN. | 23 |
| | 2+3 | 3.15V supply generated from VCC_BB. | |
| JP45 | 1+2 | 3.0V Deep Sleep supply generated from VCC_IN. | 23 |
| | 2+3 | 3.0V Deep Sleep supply generated from VCC_BB. | |
| JP46 | Open | VCC_BB rail active during deep sleep. | 23 |
| | Closed | VCC_BB rail shuts down during deep sleep. | |
| JP47 | 1+2 | Deep Sleep flip-flop DFF1 set/reset action controlled by GPO_11 and GPO_17. | 23 |
| | 2+3 | Deep Sleep flip-flop DFF1 set/reset action controlled by only GPO_17. | |
| JP48 | Open | LCD_MODE0 bit set to 1. | 27 |
| | Closed | LCD_MODE0 bit set to 0. | |
| JP49 | Open | LCD_MODE1 bit set to 1. | 27 |
| | Closed | LCD_MODE1 bit set to 0. | |
| JP50 | Open | LCD_MODE2 bit set to 1. | 27 |
| | Closed | LCD_MODE2 bit set to 0. | |
| JP51 | Open | Processor signal GPO_4 free for external use. | 27 |
| | Closed | Processor signal GPO_4 used to control LCD_ENA input. | |

20 phyCORE-LPC3250 SOM Connectivity

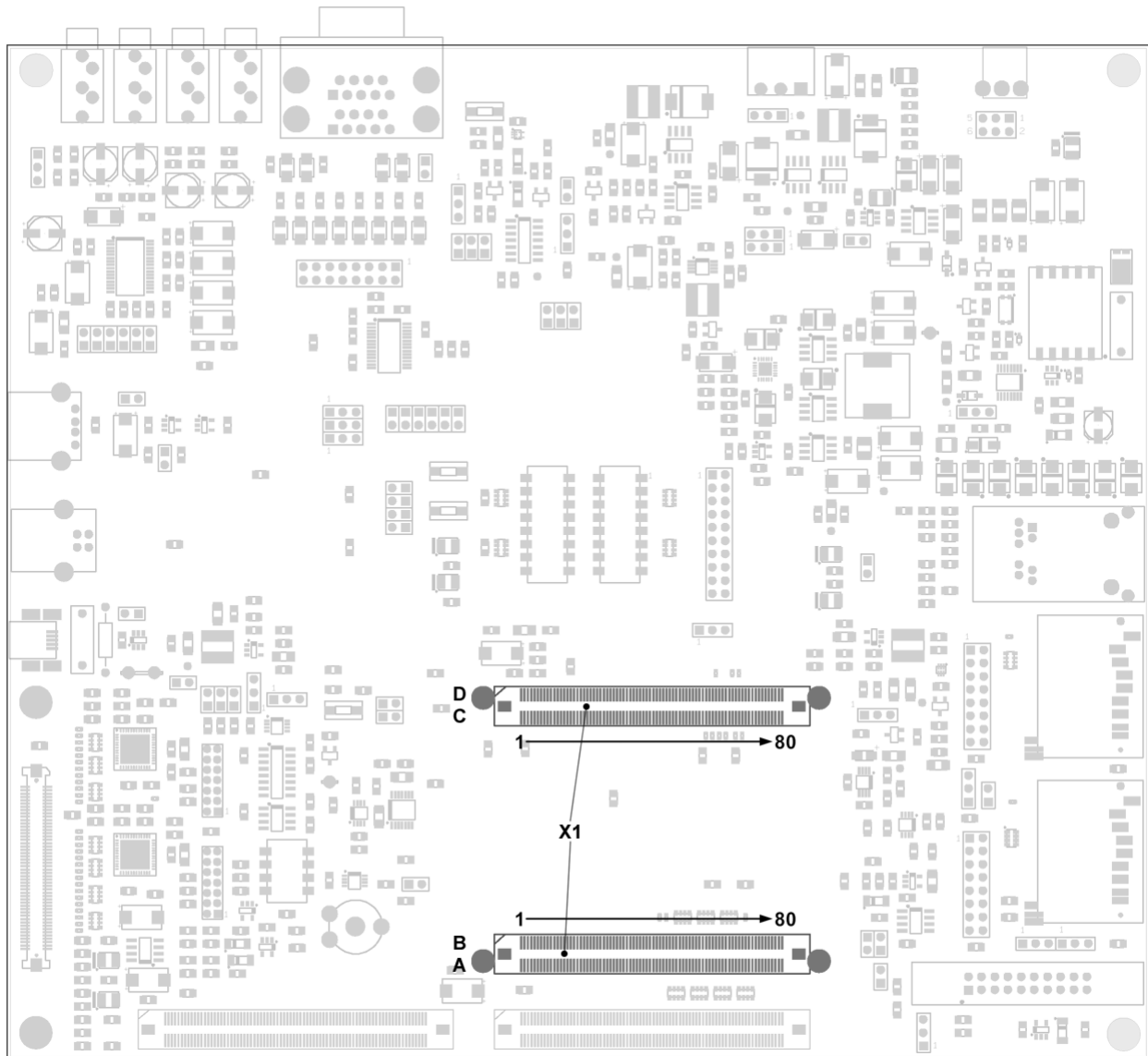

Fig. 20-1. phyCORE-LPC3250 SOM Connectivity to the Carrier Board

Connector X1 on the Carrier Board provides the phyCORE-LPC3250 System on Module connectivity. The connector is keyed for proper insertion of the SOM. [Figure 20-1](#) above shows the location of connector X1, along with the pin numbering scheme.

21 Power

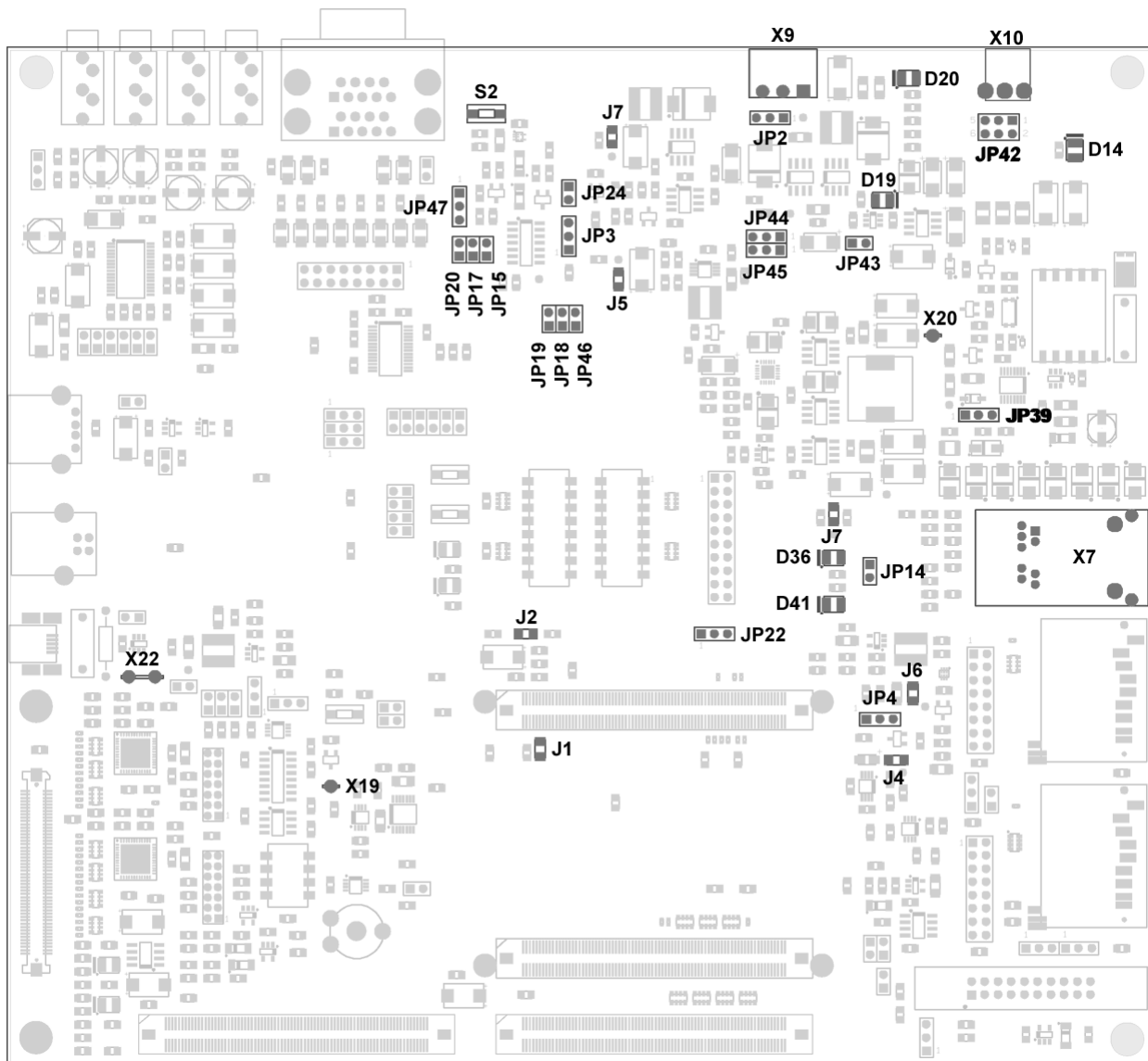

Fig. 21-1. Powering Scheme

The phyCORE-LPC3250 Carrier Board powering scheme provides a flexible platform for a variety of powering configurations. Board power sourcing includes a wall adapter, Power-over-Ethernet, or a battery supply. A number of the on-board power supplies have configurable input sources along with shutdown control during a sleep.

Figure 21-2 presents a block diagram of the Carrier Board powering scheme. Primary input power is selected via jumper JP42 and comes from either the wall adapter jack X10, or the Power-over-Ethernet circuit U2 (via the Ethernet jack X7) to generate the VIN signal. VIN is both an input into the battery charging circuit U8 as well as an input into the power path control U22. The power path control U22 generates the output VCC_IN from one of the two inputs VIN, or V_LIBAT, and automatically selects which one is routed to the output VCC_IN. When VIN is present VCC_IN is always sourced from VIN. When VIN is absent (removal of wall power or Ethernet cable) VCC_IN is sourced from the lithium-ion battery output V_LIBAT. All board power supplies ultimately generate power from VCC_IN.

The primary 5V regulator U21 is a buck-boost regulator sourced from VCC_IN and can be used as the main board power source for the downstream regulators via the VCC_BB rail. Alternatively JP44 and JP45 can be configured to source the 3.15V, and 3.0V supplies directly from VCC_IN instead. These two scenarios provide a method of testing maximal battery life configuration.

In one configuration U21, U9, and U11 are all sourced from VCC_IN. During deep sleep U9 and U21 are shutdown, leaving only U11 operating and supplying the sleep power. In this configuration U11 is essentially drawing its power directly from the lithium-ion battery (through the power path controller).

In the second configuration U21 is sourced from VCC_IN while U9 and U11 are sourced from VCC_BB, which is the output of U21. During deep sleep only U9 is shut down. In this configuration U11 draws its power from a U21, which in turn is getting its power directly from the battery.

This multi-configuration approach allows you to test which scenario is more efficient with your battery. 4.2V lithium-ion batteries tend to have very little power left when drained down to 3V. In the first configuration this is ideal. If we expect the battery to have very little life left at 3V then there is no need to put the battery through a buck-boost regulator and then regulate this down to 3.0V for the deep sleep power; this wastes power through conversion losses in U21. On the other hand it may be unknown exactly how much power remains in the battery when it is down around 3V. The second configuration allows the buck-boost regulator U21 to operate in the boost region and continue to provide power from the battery all the way down to 2.7V. The additional power gained from continuing to draw on the battery down to 2.7V instead of 3.0V may or may not be advantageous over the power losses in the buck-boost regulator; in essence it could be more power efficient overall to not try and derive that little bit of power left at the end of battery life and instead spare the power losses incurred in the buck-boost regulator by connecting the 3.0V deep sleep supply directly to the battery output (VCC_IN essentially). The phyCORE-LPC3250 Carrier Board allows you to test both configurations with the battery you decide to use in your end application.

A detailed list of the JP44 and JP45 configuration jumpers is presented below.

- JP44** Configures the VCC_3V15 supply U9 input power source. By default this jumper is in the 1+2 position, selecting VCC_IN as the power input source. Alternatively this jumper can be set to the 2+3 position, selecting VCC_BB as the input power source.
- JP45** Configures the VCC_3V0 supply U11 input power source. By default this jumper is in the 1+2 position, selecting VCC_IN as the power input source. Alternatively this jumper can be set to the 2+3 position, selecting VCC_BB as the input power source.

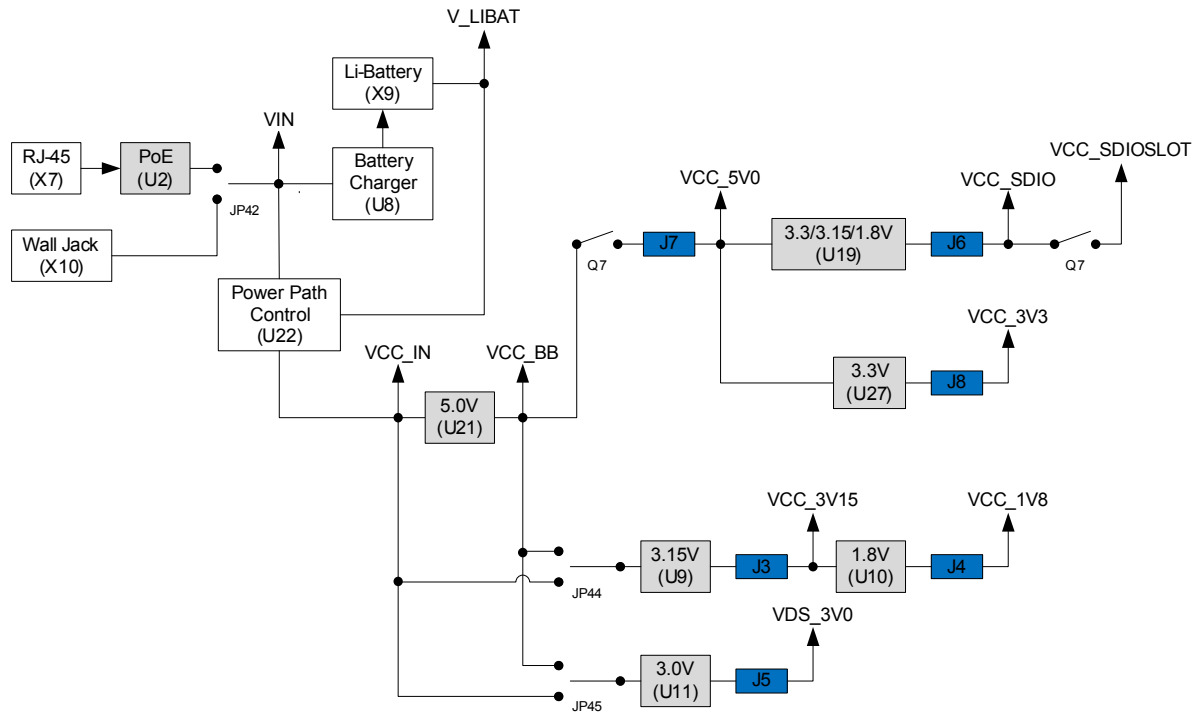

Fig. 21-2. Powering Scheme Block Diagram

The following sections in this chapter describe each power block in detail.

CAUTION:

Do not use a laboratory adapter to supply power to the Carrier Board! Power spikes during power-on could destroy the phyCORE module mounted on the Carrier Board! Do not change modules or jumper settings while the Carrier Board is supplied with power!

21.1 Wall Adapter Input

Permissible input voltage: +5 VDC regulated.

The primary input power to the phyCORE-LPC3250 Carrier Board is located at connector X10 as shown in Figure 21-2 above. The required load current capacity of the power supply depends on the specific configuration of the phyCORE-LPC3250 mounted on the Carrier Board, in addition to the particular interfaces enabled while executing software. An adapter with a minimum supply of 2600mA is recommended.

A detailed list of applicable configuration jumpers is presented below.

JP42 Configures primary input power source. By default this jumper is set to 4+6/5+3, sourcing board power from the wall adapter input. Alternatively this jumper can be set to 4+2/1+3, sourcing board power from the Power-over-Ethernet circuit.

D20 Shows the status of the input power supply (wall power or PoE). When illuminated the supply is active.

21.2 Power over Ethernet (PoE)

The Power-over-Ethernet (PoE) circuit provides a method of powering the board via the Ethernet interface. In this configuration the phyCORE-LPC3250 Carrier Board acts as the Powered Device (PD) while the connecting Ethernet interface acts as the Power Source Equipment (PSE). For applications that require Ethernet connectivity this is an extremely convenient method to also simultaneously provide power.

To make use of the PoE circuit you must have a PSE for connectivity. Typically a PoE enabled router or switch can be used. [Table 21-1](#) provides a list of possible Power Sourcing Equipment you can purchase to interface the phyCORE-LPC3250 PoE circuit if you do not already have a PSE.

Table 21-1. Possible Ethernet PSE Options

| Device | Description |
|----------|---|
| FS108P | Netgear 8-port Ethernet switch with 4-port PoE support. |
| TPE-101I | TRENDnet single port PoE injector |

The IEEE PoE standard restricts the maximum amount of power a PSE must provide and therefore a PD can consume. The phyCORE-LPC3250 PoE circuit was designed to provide up to 8.5W of power to the board. Note that this is less than the wall adapter can supply and less than the board can potentially consume. Be aware that this limitation could cause board operation to fail if peak power is exceeded due to enabled peripherals.

The phyCORE-LPC3250 Carrier Board Ethernet connector X7 supports both PSE power sourcing methods of power over the data wires, or power over the spare wires.

A detailed list of applicable configuration jumpers and LED indicators is presented below.

- JP39** Controls the PoE signature resistor internal to the Linear Tech LTC4267 PoE IC. By default this jumper is set to the 2+3 position, enabling the 25k signature resistor. Alternatively this jumper can be set to the 1+2 position, disabling the 25k signature resistor. For normal operation this jumper should be set to the 2+3 position, but in some applications it may be necessary to disable the signature resistor.
- JP42** Configures primary input power source. By default this jumper is set to 4+6/5+3, sourcing board power from the wall adapter input. Alternatively this jumper can be set to 4+2/1+3, sourcing board power from the Power-over-Ethernet circuit.
- D14** PoE 5V power indicator. When illuminated the PoE circuit is actively generating 5V.
- D36** Ethernet LINK status indicator. When illuminated the Ethernet interface has established a link to the network.
- D41** Ethernet ACTIVITY status indicator. When illuminated the Ethernet interface is active on the network.

21.3 Lithium-Ion Battery

The NXP LPC3250 processor is well suited for low power applications, and as such makes it an ideal candidate for battery operation. The phyCORE-LPC3250 Carrier Board provides a lithium-ion battery input and battery charging circuit at U8 to support this.

In general you should use the PHYTEC supplied battery with the phyCORE-LPC3250 Carrier Board. Caution should be exercised when using your own battery. You should only use 4.2V lithium-ion batteries capable of a 1.1A charging current. You should consult PHYTEC before using your own battery.

To use the battery option to power the board plug the PHYTEC supplied lithium-ion battery into connector X9 on the Carrier Board. If the board is already powered via the PoE circuit, or the wall adapter input, the battery will begin charging if the battery charging circuit detects an under voltage condition (see [Chapter 21.3.1](#) for details) on the battery. The PoE supply or wall adapter input can be removed at any time to begin powering the board from the battery. The transition is seamless between PoE/wall power, and battery power. Likewise the connection of PoE or wall power after the board is running from the battery is seamless. Removing and inserting the external supplies should not affect board operation.

21.3.1 Battery Charging Circuit

The battery charging circuit located at U8 is capable of recharging a 4.2V lithium-ion battery with a 1.1A charging current when the board is powered from the PoE circuit or the wall adapter. Battery charging is automatic when an alternate board power source is available. The battery charging will cease when the battery becomes fully charged.

To charge the PHYTEC supplied lithium-ion battery plug the battery into connector X9 on the Carrier Board while the board is powered via the wall adapter or PoE circuit. The red "Charging" LED D19 will illuminate during a charging cycle.

A detailed list of applicable configuration jumpers is presented below.

JP2 Configures the LTC4002 battery temperature monitoring function. By default this is set to the 2+3 position, disabling temperature monitor control. To enable this feature set the jumper to the 1+2 position^a.

D19 Battery charging status indicator. When illuminated the connected lithium-ion battery is being charged.

a. The battery must have an applicable thermistor integrated into the package for this function to operate properly

21.4 3.15V Supply (U9)

The Linear Technology LTC1622 switching regulator populated at U9 provides the primary VCC=3.15V power to the phyCORE-LPC3250 System on Module. In addition many of the peripheral support components are also powered via the 3.15V supply.

A detailed list of applicable configuration jumpers is presented below.

JP44 Configures the VCC_3V15 supply U9 input power source. By default this jumper is in the 1+2 position, selecting VCC_IN as the power input source. Alternatively this jumper can be set to the 2+3 position, selecting VCC_BB as the input power source

J3 Current measurement access point jumper. By default this jumper is populated with a 1206 packaged 0 Ohm resistor. See [Chapter 21.8](#) for techniques on measuring current at this jumper.

21.5 1.8V Supply (U10)

The National Instruments LP2951 LDO regulator populated at U10 provides 1.8V for processor I/O compatibility. Because of the multi voltage nature of the LPC3250 several of the I/O pins operate at 1.8V instead of the primary VCC voltage of 3.15V. In general this 1.8V supply is used simply to power voltage translation buffers like the 74AVC2T45.

A detailed list of applicable configuration jumpers is presented below.

- J4** Current measurement access point jumper. By default this jumper is populated with a 1206 packaged 0 Ohm resistor. See [Chapter 21.8](#) for techniques on measuring current at this jumper.

21.6 5.0V Buck-Boost Supply (U21)

The Linear Technology LTC3785 buck-boost switching regulator populated at U21 provides 5V required by USB peripherals, the LCD interface, and can also be used as the input source to other downstream regulators. U21 generates two voltage rails called VCC_BB and VCC_5V0. Both rails are at 5V. The VCC_5V0_OFF signal provides on/off control over the VCC_5V0 rail while the VCC_BB rail remains active as long as the board is powered. U21 derives its power from the active board powering source, which can either be the wall adapter, PoE, or lithium-ion battery. As discussed in [Chapter 21](#) it may be beneficial for the downstream regulators to be powered via VCC_BB instead of the primary board input power source. Refer to [Chapter 21](#) for a detailed explanation of the pros/cons of using the VCC_BB rail for downstream regulators.

A detailed list of applicable configuration jumpers is presented below.

- J7** Current measurement access point jumper. By default this jumper is populated with a 1206 packaged 0 Ohm resistor. See [Chapter 21.8](#) for techniques on measuring current at this jumper.

21.7 Power Path Controller

The Linear Technology LTC4412 power path controller populated at U22 is responsible for automatic battery switching when primary board power is removed. Under normal operating conditions the wall adapter or Power-over-Ethernet output will be powering the board. U22 automatically, and seamlessly transitions from wall adapter/PoE power to battery power without interrupting board operation.

A detailed list of applicable configuration jumpers is presented below.

- JP43** Path configuration control. By default this jumper is set to the OPEN position, allowing the circuit to operate as normal. Alternatively this jumper can be set to the CLOSED position, forcing the power path controller to always source power from the wall adapter/PoE input. This setting can be useful if you do not want the system to draw power from the battery when unplugged, and instead be powered down.

21.8 Current Measurement

To facilitate current measurement jumpers J3 through J8 are provided as current access measurement points. Replace these jumpers with 1206 packaged precision shunt resistors and measure the resulting voltage drop across the shunt resistor to calculate current draw. A good value to start with for your shunt resistor is 25milliOhms. The shunt resistor should be small enough to not affect the output voltage (it will be reduced by the voltage drop across the shunt), but large enough to have a discernible measurement from general noise.

22 JTAG Connectivity

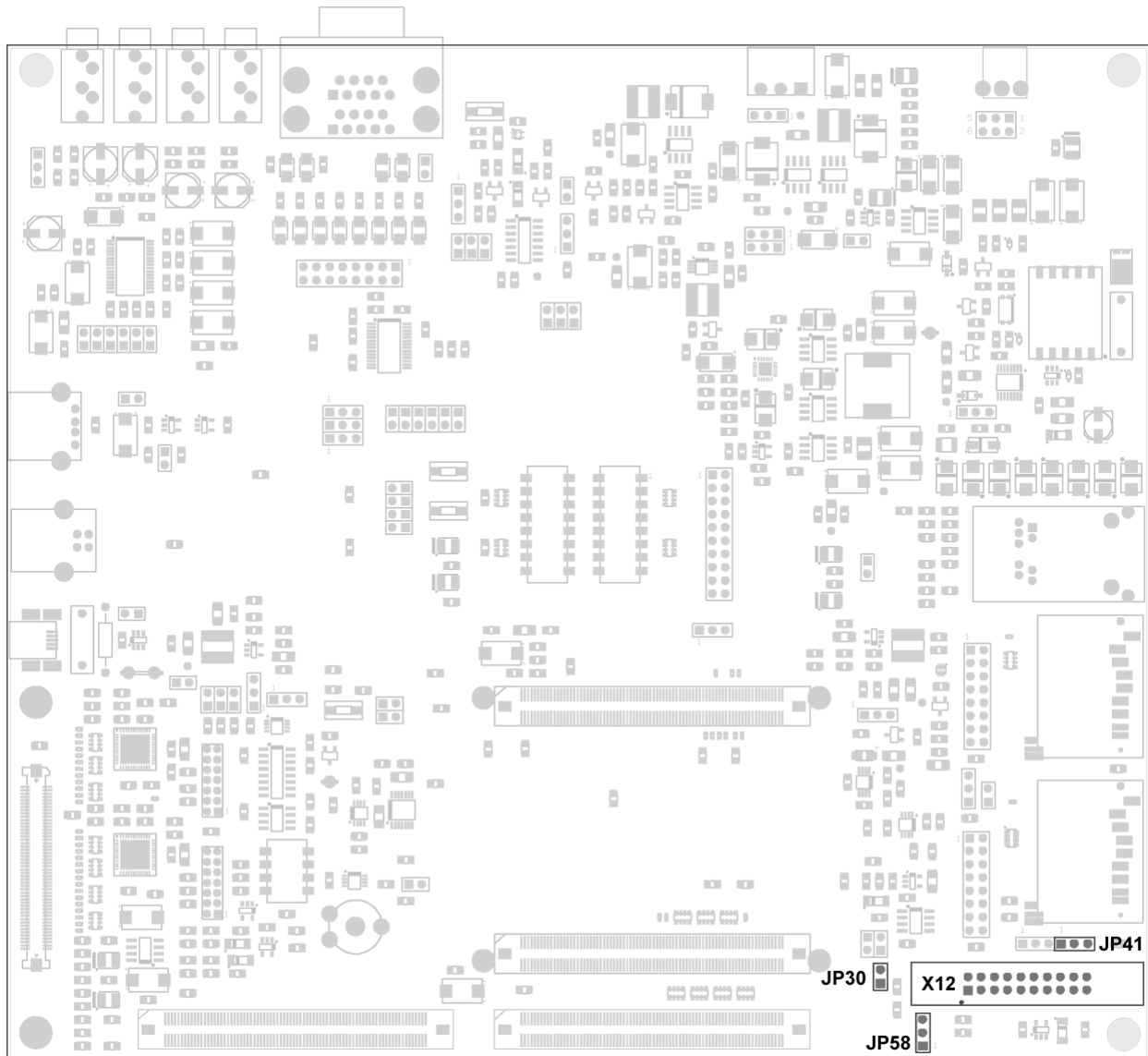

Fig. 22-1. JTAG Probe Connectivity to the LPC3250

Connector X12 provides a convenient JTAG probe connection interface for ARM compatible JTAG probes to the LPC3250. [Table 22-1](#) provides a detailed list of the signals at the JTAG connector. You should cross reference this with your JTAG probe to ensure compatibility.

Table 22-1. LPC3250 JTAG Connector X12 Pin Descriptions

| Pin | Signal | Description |
|-----|---------|--|
| 1 | VTREF | Ref voltage input. Connected to VCC=3.15V. |
| 2 | VSUPPLY | Supply input. Connected to VCC=3.15V. |
| 3 | /TRST | Test controller reset input with internal 10k pull-up. |
| 4 | GND | Ground. |

Table 22-1. LPC3250 JTAG Connector X12 Pin Descriptions (Continued)

| Pin | Signal | Description |
|-----|--------|---|
| 5 | TDI | Test data input with internal 10k pull-up. |
| 6 | GND | Ground. |
| 7 | TMS | Test mode select input with internal 10k pull-up. |
| 8 | GND | Ground. |
| 9 | TCK | Test clock input with internal 10k pull-down. |
| 10 | GND | Ground. |
| 11 | RTCK | Return test clock output with internal 10k pull-down. |
| 12 | GND | Ground. |
| 13 | TDO | Test data output. |
| 14 | GND | Ground. |
| 15 | /SRST | System reset input with internal 10k pull-up. |
| 16 | GND | Ground. |
| 17 | N/C | Not connected. |
| 18 | GND | Ground. |
| 19 | N/C | Not connected. |
| 20 | GND | Ground. |

As of the printing of this manual [Table 22-2](#) lists JTAG probes which are known to be compatible to the phyCORE-LPC3250 Carrier Board JTAG interface.

Table 22-2. Compatible JTAG Probes for the phyCORE-LPC3250 Carrier Board

| JTAG Probe Name |
|-------------------------|
| Keil U-Link and U-Link2 |
| Segger J-Link |
| Abatron BDI2000 |
| ARM Realview ICE |

Two configuration jumpers allow control over board reset functionality. A detailed list of applicable configuration jumpers is presented below.

- JP30** Controls enabling boundary scan mode for the processor. By default this jumper is opened, configuring the LPC3250 for normal JTAG debug operation. Close this jumper to enable boundary scan mode operation for the processor.
- JP41** Controls the power source to the JTAG /SRST circuit. By default this jumper is set to the 1+2 position, configuring the interface to drive the /RESET_SYS input to the phyCORE-LPC3250. Alternatively this jumper can be set to the 2+3 position, configuration the interface to drive the /RESET_BAT input to the phyCORE-LPC3250. This jumper must be changed in conjunction with jumper JP58. Both JP41 and JP58 must be in the 1+2 position, or both in the 2+3 position.

JP58 Controls which reset input the JTAG /SRST signal drives. By default this jumper is set to the 1+2 position, configuring the interface to drive the /RESET_SYS input to the phyCORE-LPC3250. Alternatively this jumper can be set to the 2+3 position, configuration the interface to drive the /RESET_BAT input to the phyCORE-LPC3250. This jumper must be changed in conjunction with jumper JP41. Both JP41 and JP58 must be in the 1+2 position, or both in the 2+3 position.

The /RESET_SYS signal is the system reset input to the phyCORE-LPC3250. Driving this signal LOW will cause a system reset. The /RESET_BAT signal is the system + sleep reset input to the phyCORE-LPC3250. Driving this signal LOW will cause a system reset just as the /RESET_SYS signal, and in addition will reset the sleep circuitry. If it is required to be able to have reset control over the sleep circuitry (which is normally only reset should a sleep voltage fail) via the JTAG probe during test/debug then configure the JP41/JP58 jumper combo to drive the /RESET_BAT signal, otherwise leave the jumpers in their default configuration to provide a system wide reset via /RESET_SYS.

23 Deep Sleep Circuit

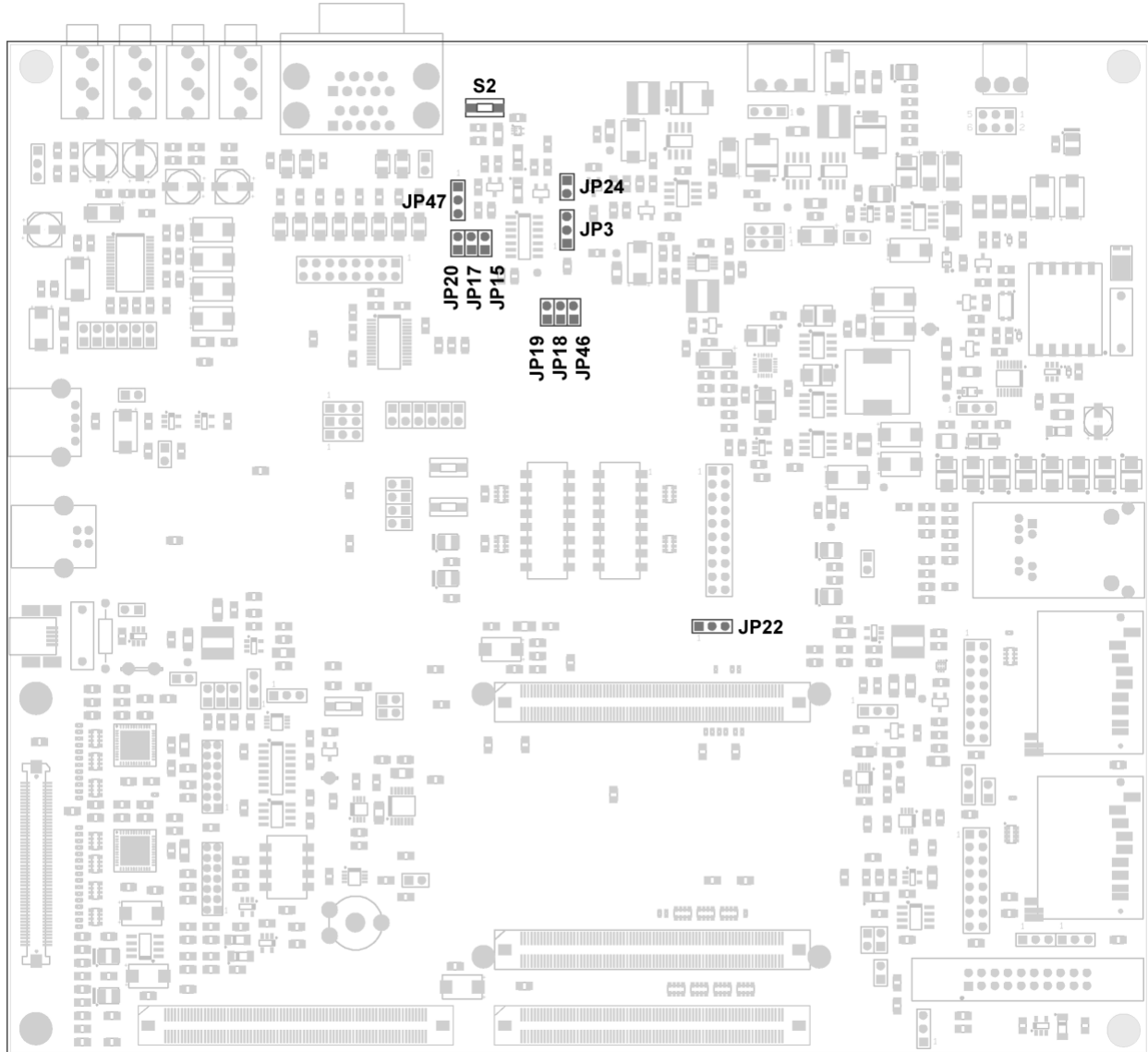

Fig. 23-1. Deep Sleep Jumpers and Power Button

The deep sleep circuit is responsible for power supply control and tracking deep sleep status. This circuit coupled with sleep designed features on the phyCORE-LPC3250 allow the processor to shut down primary system power supplies while maintaining SDRAM and RTC power. [Figure 23-2](#) shows a block diagram of the phyCORE-LPC3250 Carrier Board power system and deep sleep circuit, along with connectivity to the phyCORE-LPC3250 System on Module.

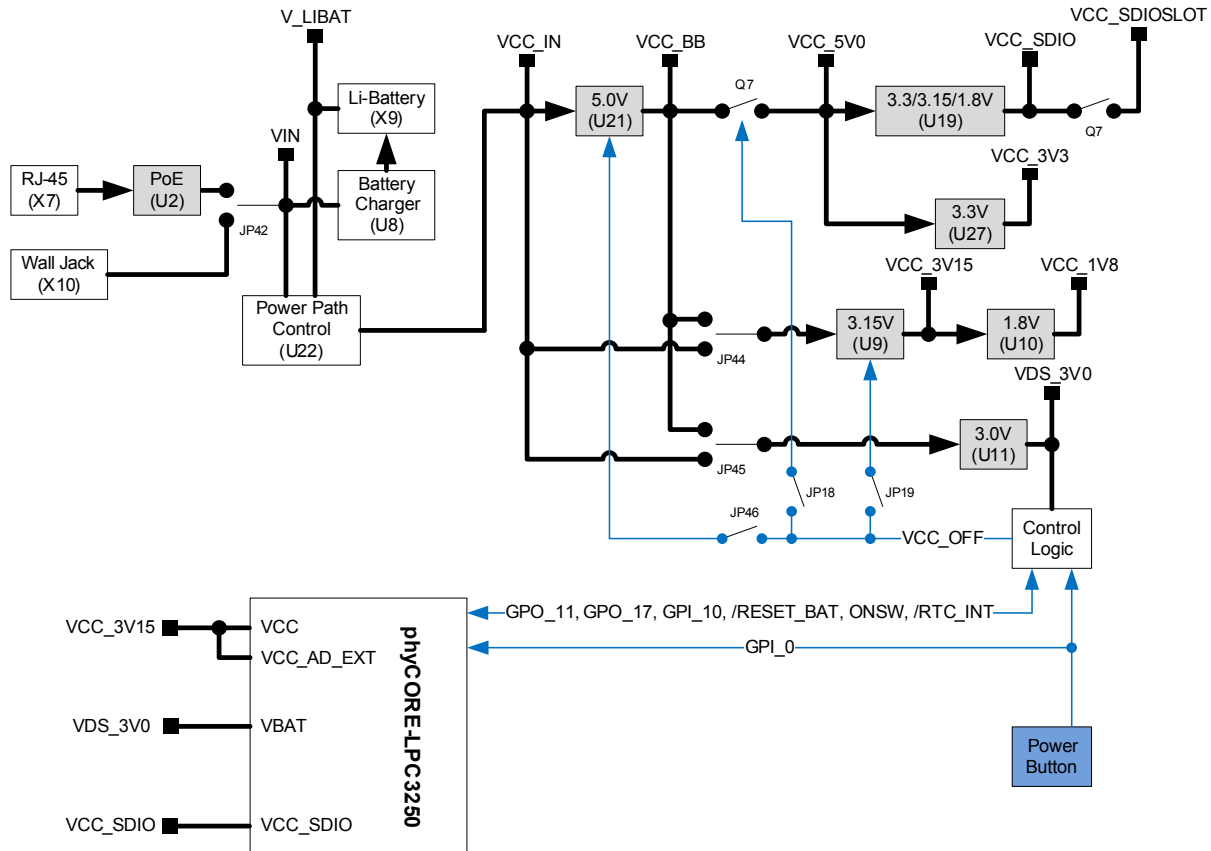

Fig. 23-2. Deep Sleep Circuit Block Diagram

In [Figure 23-2](#) the deep sleep circuitry is represented by the Control Logic block. This block is composed of two D flip-flops, some transistors, diodes, and resistors. Connectivity of the Control Logic to the phyCORE-LPC3250 consists of 6 different signals: GPO_11, GPO_17, GPI_19, /RESET_BAT, ONSW, and /RTC_INT. In addition the power button is interfaced via the GPI_0 signal. A detailed description of signal usage is presented below.

- GPO_11** This processor signal connects to the deep sleep clear input. When toggled HIGH this signal clears the deep sleep flip-flop DFF1 (see schematics), setting the Q_bar output to HIGH. This is indicative of a wake state.
- GPO_17** This processor signal connects to the deep sleep set input. When toggled HIGH this signal sets the deep sleep flip-flop DFF1 (see schematics), setting the Q_bar output to LOW and shutting down system power. This is indicative of a sleep state.
- GPI_19** This processor signal connects to the deep sleep state output. When read, a HIGH indicates a wake state, and a LOW indicates a sleep state.
- /RESET_BAT** This signal is generated on the SBC and is the reset output of the sleep supervisor. If the on-board RTC or SDRAM supplies fail or the sleep voltage VDS_3V0 fails (monitored as VBAT on the SBC) this signal will go LOW causing a reset to the deep sleep state flip-flop DFF1 (set to wake state).

- ONSW** This processor signal is the alarm output of the on-chip RTC block. When active (a HIGH going pulse) this signal enables the system power supplies (5V and 3.15V) causing the system to begin booting.
- /RTC_INT** This signal is the alarm output of the off-chip RTC on the SBC. When active (a LOW going pulse) this signal enables the system power supplies (5V and 3.15V) causing the system to begin booting.
- GPI_0** This processor signal is connected to the power switch output and senses a press of the power switch button. When pressed the system should begin the sleep shutdown process via software.

The Power Switch output is routed to both the deep sleep control circuitry and the phyCORE-LPC3250 SOM. The deep sleep circuitry only responds to the power switch when power has been removed. Pressing the power switch will reapply system power. If system power is already applied then pressing the power switch has no effect on the deep sleep circuitry. The phyCORE-LPC3250 only responds to the power switch when the system is powered. The phyCORE-LPC3250 monitors the power switch (via an edge triggered interrupt on GPI_0) and initiates a system sleep when the power switch has been pressed.

Figure 23-3 presents a state diagram of the entire sleep cycle from the system running, to the powered-down stage, back to the system running again. The system starts in the System Off state where power is either removed completely from the board (no wall adapter, battery, or PoE) or the on-board regulators are shut down and the deep sleep supply VDS_3V0 is active. The system begins powering up through one of four events:

1. The on-chip RTC generates an alarm signal via the ONSW output. The ONSW output signals the deep sleep circuitry to enable the on-board regulators.
2. The off-chip RTC generates an alarm signal via the /RTC_INT output. The /RTC_INT output signals the deep sleep circuitry to enable the on-board regulators.
3. The power button is pressed, signaling to deep sleep circuitry to enable the on-board regulators.
4. The system is powered up for the very first time and the Carrier Board is configured via jumper JP3 to apply system power after a /RESET_BAT event.

After power is applied and the voltage supervisors have taken the system out of reset (supplies have stabilized) the system begins booting. In the first part of the boot process the user supplied bootloader checks the status of GPI_19 to read the deep sleep state. If GPI_19 is set to HIGH then the system boots normally. If GPI_19 is set to LOW the system boots knowing it was previously in deep sleep and the contents of SDRAM and the RTC block are known and good. After booting has completed the system is in the System Running state. From this point the system will operate until the next time it needs to enter deep sleep. The system will enter deep sleep again via two methods:

1. The power button is pressed.
2. An internal event triggers a sleep request

In (1) the system detects the power button press via an edge triggered interrupt on GPI_0. In (2) an internal event such as a count down timer expires. Both result in a request for the system to enter a sleep state. At this point the software takes the appropriate measures to prepare for sleep. The last step to enter deep sleep and shut down the system power supplies is to set GPO_17 high. This sets the deep sleep state flip-flop to the sleeping state and triggers the removal of system power. The system has now come full circle back to the System Off state.

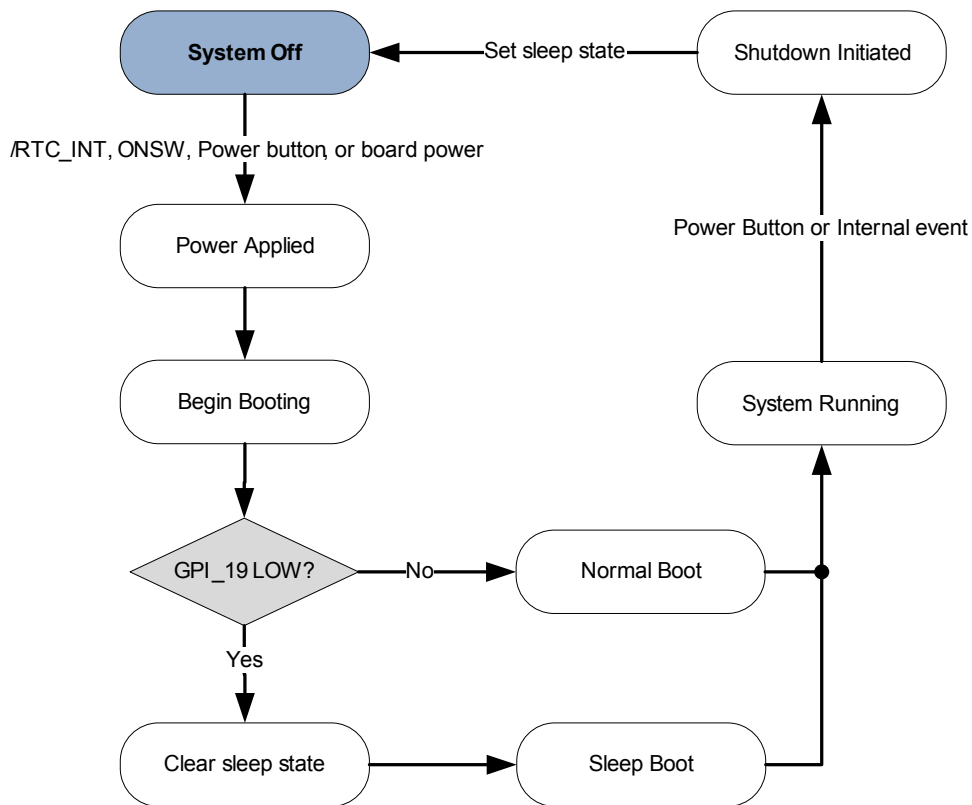

Fig. 23-3. Deep Sleep State Diagram

Various configuration jumpers allow customizing the operation of the deep sleep circuit. A detailed list of applicable configuration jumpers is presented below.

- JP3** Configures the power reset behavior after a /RESET_BAT event. By default this jumper is in the 1+2 position, setting the board to the power off state after a /RESET_BAT event. Alternatively this jumper can be set to the 2+3 position, setting the board to the power up state after a /RESET_BAT event. /RESET_BAT event will occur at the very first application of board power or during a fault on the battery supervisor rails (VBAT, VCC_RTC, VCC_SDRAM).
- JP15** Connects processor input signal GPI_19 to the /DS_STATE output signal of the deep sleep state flip-flop DFF1, allowing the processor to read the sleep state. By default this jumper is set to the closed position, connecting GPI_19 to the /DS_STATE signal. Remove this jumper to free GPI_19 for external use.
- JP17** Connects processor output signal GPO_17 to the DS_SET input signal of the deep sleep state flip-flop DFF1, allowing the processor to set the sleep state. Remove this jumper to free GPO_17 for external use.

- JP18** Connects the deep sleep circuitry VCC_OFF output signal to the 5V peripheral supply OFF input. By default this jumper is closed, shutting off the 5V peripheral supply when the system enters deep sleep. Remove this jumper to keep 5V peripheral circuitry alive during a sleep. 5V peripheral circuitry will potentially include LCD and powered USB peripherals. Reference the Carrier Board schematics for details.
- JP19** Connects the deep sleep circuitry VCC_OFF output signal to the primary 3.15V supply OFF input. By default this jumper is closed, shutting off the 3.15V supply when the system enters deep sleep. Remove this jumper to keep 3.15V circuitry alive during a sleep. 3.15V circuitry includes the phyCORE-LPC3250 along with most of the supporting circuitry on the Carrier Board. Reference the Carrier Board schematics for details.
- JP20** Connects processor output signal GPO_11 to the DS_CLEAR input signal of the deep sleep state flip-flop DFF1, allowing the processor to clear the sleep state. Remove this jumper to free GPO_11 for external use.
- JP22** Reserved for future use. Keep this jumper set at the default 2+3 position.
- JP24** Connects the off-chip RTC output signal /RTC_INT to the deep sleep power control flip-flop DFF2. By default this jumper is closed allowing the off-chip RTC to reapply power during deep sleep. Remove this jumper to disable this function.
- JP46** Connects the deep sleep circuitry VCC_OFF output signal to the 5V buck-boost peripheral supply OFF input. By default this jumper is closed, shutting off the 5V buck-boost peripheral supply when the system enters deep sleep. Refer to [Chapter 21](#) for a detailed explanation on using this jumper. Remove this jumper when JP45 is set to 2+3 or JP44 is set to 2+3.

23.1 3.0V Deep Sleep Supply (U11)

The Linear Technology LTC1877 switching regulator populated at U11 provides the 3.0V deep sleep power maintained during a sleep condition. This supply only provides power to the deep sleep circuit and the VBAT input pin on the phyCORE-LPC3250.

A detailed list of applicable configuration jumpers is presented below.

- JP45** Configures the VCC_3V0 supply U11 input power source. By default this jumper is in the 1+2 position, selecting VCC_IN as the power input source. Alternatively this jumper can be set to the 2+3 position, selecting VCC_BB as the input power source.
- J5** Current measurement access point jumper. By default this jumper is populated with a 1206 packaged 0 Ohm resistor. See [Chapter 21](#) for techniques on measuring current at this jumper.

24 Audio Interface

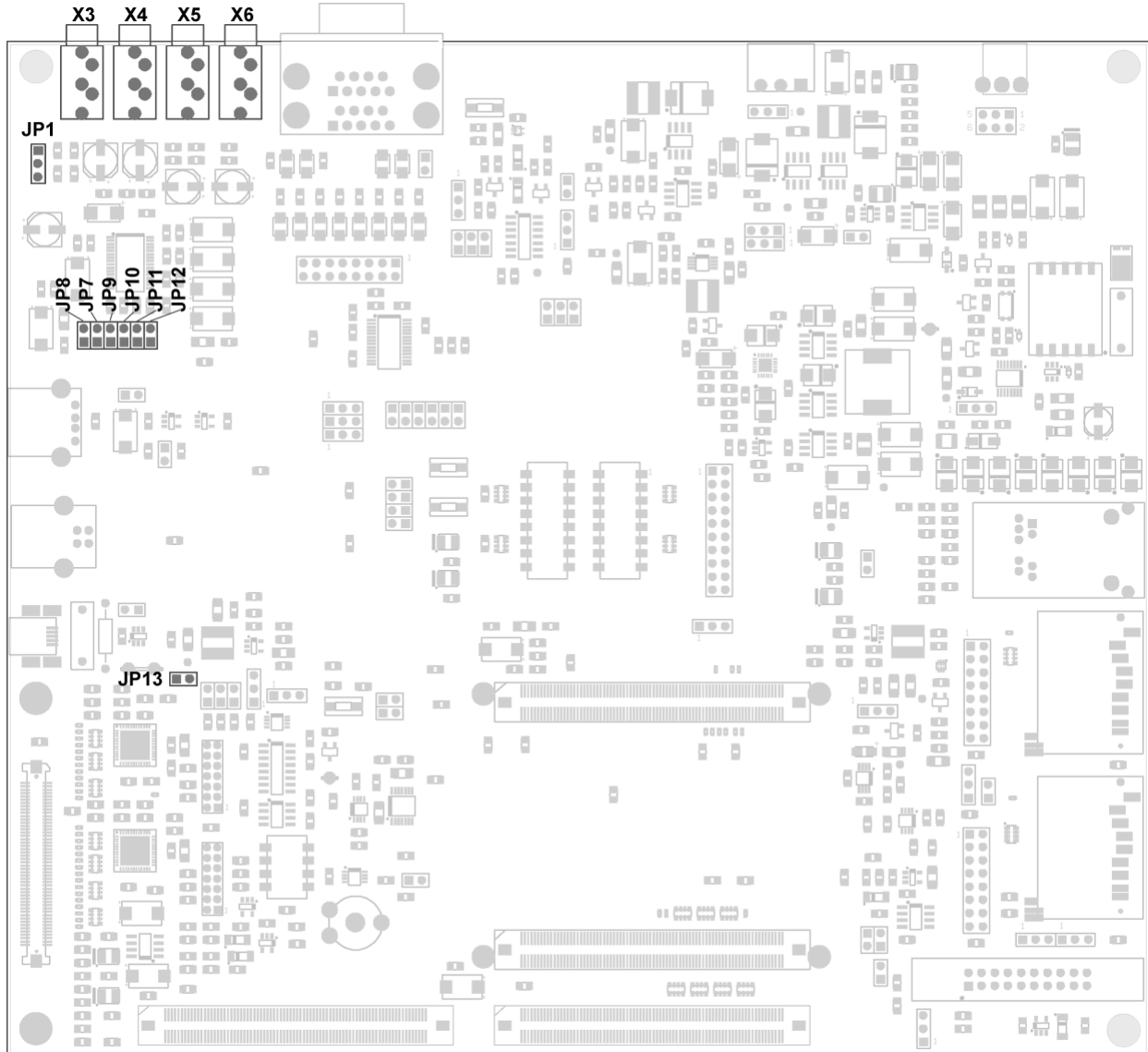

Fig. 24-1. Audio Interface Connectors and Jumpers

The audio interface provides a method of exploring the LPC3250's I²S capabilities. The phyCORE-LPC3250 Carrier Board comes populated with an NXP UDA1380 audio codec supporting a stereo line input, a mono microphone input, a stereo line output, and a stereo headphone output. The UDA1380 is interfaced to the phyCORE-LPC3250 via the I²S port 1 for audio data and the I²C port 1 for codec configuration. The codec is clocked off of the processor's I2STX_WS1 signal with the help of internal codec PLLs. Alternatively the TST_CLK2 input can be used for clocking the codec, however, a lack of suitable

dividers limits the usable bit rates with the TST_CLK2 input. Eight configuration jumpers allow flexible control over board audio connectivity. A detailed list of applicable configuration jumpers and connectors is presented below.

- X3** Mono MIC jack input - Connect this to a compatible electret type microphone. The MIC is biased via a 10k pull-up to 3.15V. Ensure that this does not exceed the biasing requirements of your MIC.

- X4** Stereo Line Input jack - Connect this to an applicable stereo audio output source producing a 1V RMS output signal (such as the LINE OUT on a PC). Applications that require a 2V RMS output signal must replace resistors R29 and R30 with 12k Ohm 0805 packaged resistors.

- X5** Stereo Line Output jack - Connect this to an applicable audio input source capable of receiving a ~0.945V RMS (typical) input signal (such as the LINE INPUT on a PC).

- X6** Stereo Headphone Output jack - Connect this to a set of headphones. This output is capable of driving a 16 Ohm load.

- JP1** MIC bias configuration jumper. By default this jumper is set to the 1+2 position, biasing a mono input microphone. This jumper may be useful for independently biasing and using either channel of a stereo MIC. Set this jumper to the 2+3 position to use and bias the right channel and 1+2 for the left channel.

- JP7** Connects the I2STX_SDA1 processor signal to the audio codec. By default this jumper is set to the closed position. Open this jumper to free this signal for external use.

- JP8** Connects the I2STX_WS1 processor signal to the audio codec. By default this jumper is set to the closed position. Open this jumper to free this signal for external use.

- JP9** Connects the I2STX_CLK1 processor signal to the audio codec. By default this jumper is set to the closed position. Open this jumper to free this signal for external use.

- JP10** Connects the I2SRX_SDA1 processor signal to the audio codec. By default this jumper is set to the closed position. Open this jumper to free this signal for external use.

- JP11** Connects the I2SRX_WS1 processor signal to the audio codec. By default this jumper is set to the closed position. Open this jumper to free this signal for external use.

- JP12** Connects the I2SRX_CLK1 processor signal to the audio codec. By default this jumper is set to the closed position. Open this jumper to free this signal for external use.

- JP13** Connects the LCD0/GPO_02 processor signal to the audio codec reset input. By default this jumper is closed. Open this jumper to free this signal for external use.

25 Ethernet Connectivity

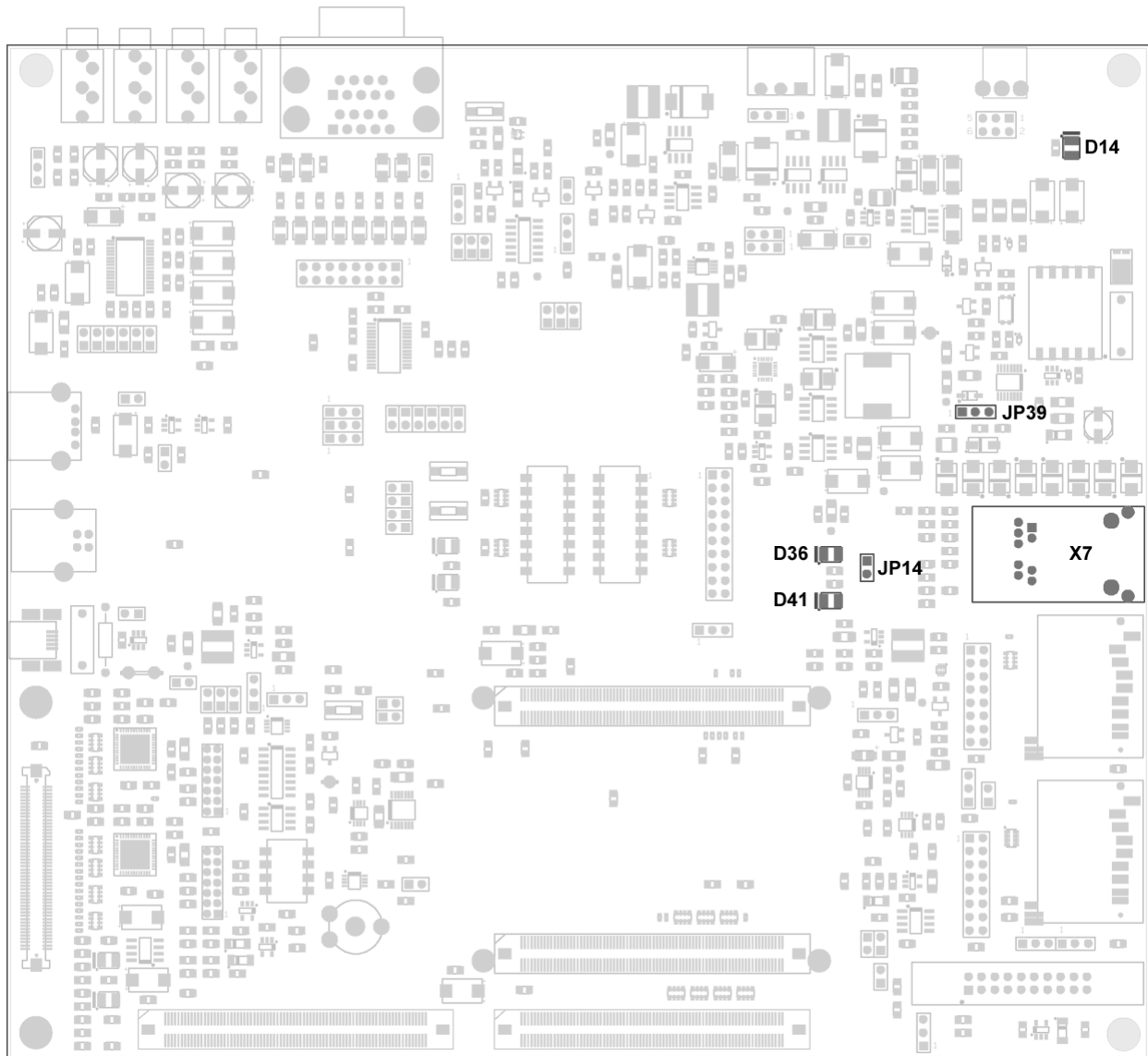

Fig. 25-1. Ethernet Interface Connectors and Jumpers

The Ethernet interface provides a method of connecting to the phyCORE-LPC3250 Ethernet functionality. One RJ-45 connector is provided at X7. This connector provides both a connection to the Ethernet data signals and the Power-over-Ethernet power signals. A LINK and ACTIVITY LED are provided on the Carrier Board at D36 and D41. One configuration jumper is provided to disable the phyCORE-LPC3250 Ethernet clock oscillator.

A detailed list of applicable configuration jumpers is presented below.

- JP14** Enables/disables the phyCORE-LPC3250 Ethernet oscillator. By default this jumper is open, enabling the phyCORE-LPC3250 Ethernet oscillator (required for Ethernet functionality). If the Ethernet interface is not used, or the keyboard interface is required, close this jumper to disable the on-board Ethernet clock oscillator. Disabling the Ethernet clock oscillator will result in a noticeable decrease in power consumption.
- JP39** Disables the PoE signature resistor internal to the LTC4267. By default this jumper is set to the 2+3 position, enabling the PoE signature resistor. Close this jumper to disable the PoE signature resistor.

For information on using the Power-over-Ethernet circuit refer to [Chapter 21.2](#).

26 USB Connectivity

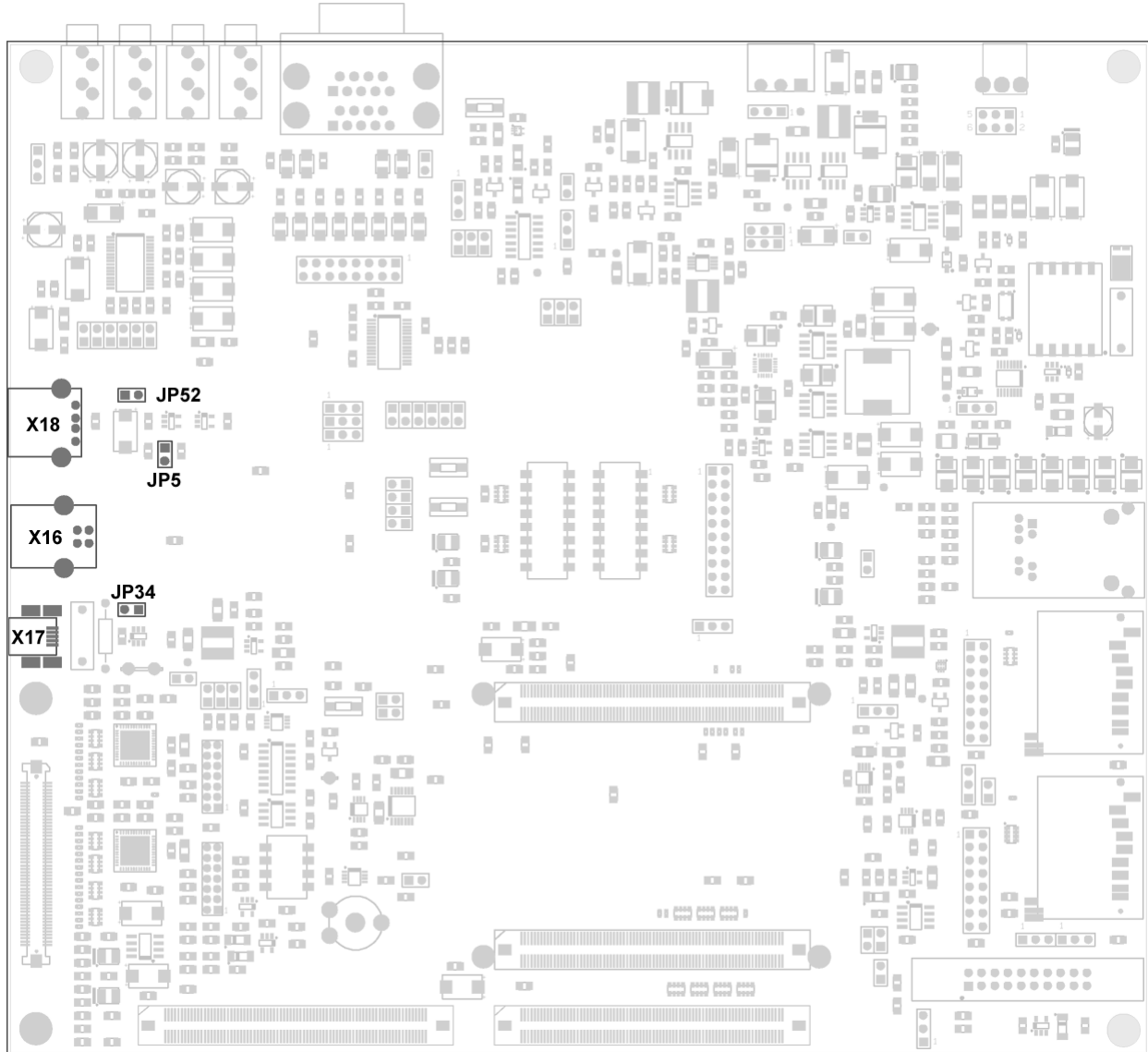

Fig. 26-1. USB Interface Connectors and Jumpers

The USB interface provides connectivity to the phyCORE-LPC3250 USB OTG functionality. Three connectors are provided for testing convenience: (1) a Standard-A Host connector X18, (2) a Standard-B Peripheral connector X16, (3) and a Mini-AB OTG connector X17. All three connectors connect to the same USB interface.

In addition to connectors an OTG configuration jumper is provided, along with additional 5V supply current for non-OTG peripherals. A USB OTG compliant device is only required to source up to 8mA of current when operating as a host. Because very few devices are OTG compliant and most USB peripherals require more than 8mA to operate, a 5V power circuit and configuration jumper have been provided to facilitate these devices.

A detailed list of applicable configuration jumpers and connectors is presented below.

- X16** USB Standard-B connection interface. Connect a USB Standard-B mating cable to this connector when operating the USB interface in Peripheral mode.
- X17** USB Mini-AB connection interface. Connect a USB OTG cable to this connector when operating the USB interface in OTG mode.
- X18** USB Standard-A connection interface. Connect a USB Standard-A mating cable to this connector when operating the USB interface in Host mode.
- JP5** Configures 5V power to connecting peripheral devices. By default this jumper is set to the 2+3 position, allowing the ISP1301 USB OTG transceiver to control the power supply during over current conditions. Alternatively this jumper can be set to the 1+2 position providing 5V power in excess of 500mA with no over current monitoring.
- JP34** Configures the OTG operating mode. By default this jumper is set to the open position, floating the USB_ID pin, and configuring the OTG interface as a peripheral. Alternatively this jumper can be set to the closed position, connecting USB_ID to GND, and configuring the OTG interface as a host. Typically the configuration of a connecting device as host or peripheral is done automatically via a USB OTG cable. However, given the limited number of OTG enabled devices in the embedded market this jumper is provided to either simulate an OTG cable, or force the OTG interface into Host mode when OTG operation is not required.
- JP52** Controls the addition of 120uF of capacitance to the USB_VBUS net. By default this jumper is in the open position, resulting in about 4.7uF of capacitance on USB_VBUS. This configuration is required when operating as an OTG device. When operating as a dedicated USB host, close this jumper to add the required 120uF of capacitance on USB_VBUS required by the USB specification.

27 LCD Connectivity

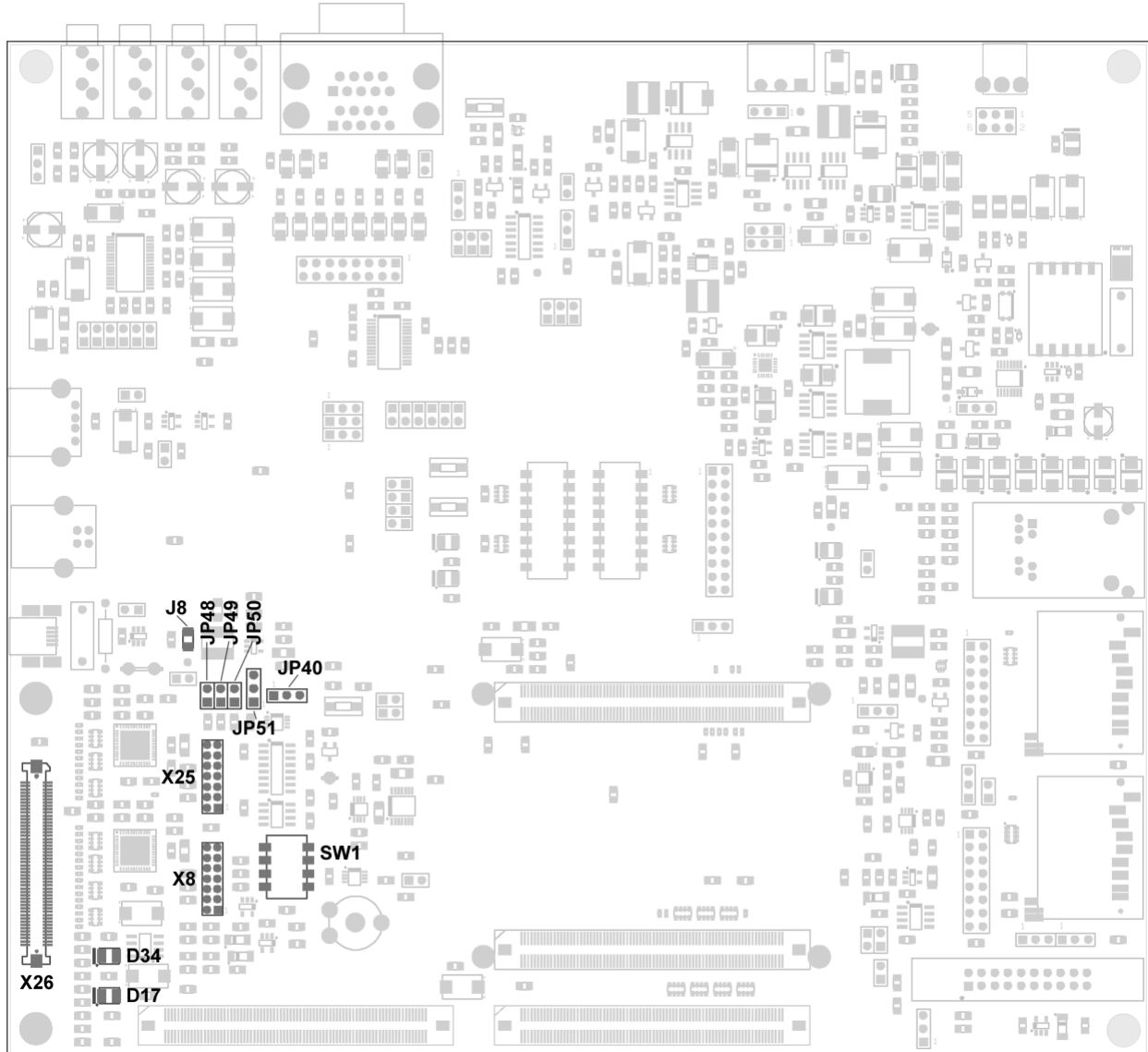

Fig. 27-1. LCD Interface Connectors and Jumpers

The phyCORE-LPC3250 Carrier Board provides a flexible LCD connection interface to support various PHYTEC provided LCD boards. The Universal LCD Connector X26 provides power, and buffered signals to connecting LCDs.

The Universal LCD Interface consists of the following components:

1. CPLDs for buffered signals and color signal control
2. 5.0V slew-rate limited power control + status LED
3. 3.3V slew-rate limited power control + status LED
4. Mode set jumpers for various LCD bit modes
5. Buffered I2C interface
6. GPIO controlled backlight and LCD enable

The CPLDs come pre-programmed supporting the 24bpp, 16bpp (5:5:5), 16bpp (5:6:5), and 12bpp (4:4:4) modes the LPC3250 LCD controller provides. The CPLDs provide two important features on the phyCORE-LPC3250 Carrier Board:

1. Buffered signal and power interface
2. Color signal control

The buffered signal and power provide a means of completely shutting off power to the LCD on-the-fly. This type of configuration allows dynamic control over system power consumption by turning off the LCD when it is not needed.

Color signal control allows dynamic reconfiguration of the color signals to support various LCD bit widths. As an example consider only the blue color signals from a 24-bit LCD and an 18-bit LCD. In the case of a 24-bit LCD Figure 29 shows the connection interface from the LPC3250 LCD port all the way to the LCD. As can be seen LCD23...16 from the processor map directly to LCD_BLUE7...0 via the CPLD U4.

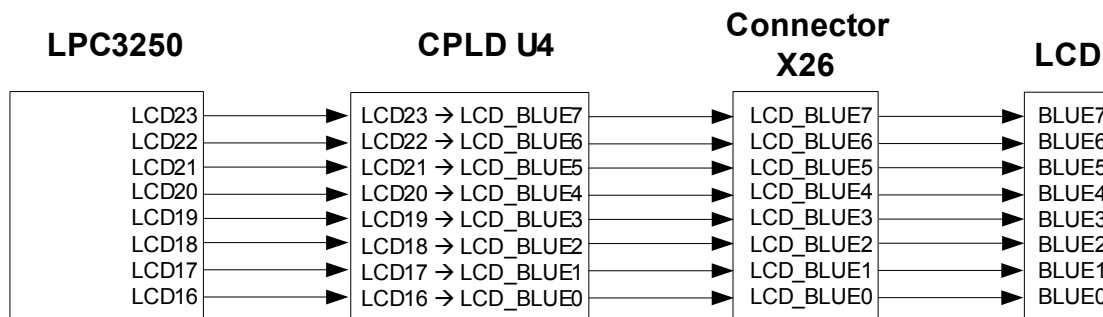

Fig. 27-2. LCD BLUE Signal Mapping in 24-bit Mode with a 24-Bit LCD

In the case of an 18-bit LCD Figure 30 shows the lower 3-bits of the BLUE signals to the connector X26 are held to 0 (LOW) by the CPLD when operating the LPC3250 in 16-bit 5:6:5 mode. The result is the upper 5 bits of the LCD blue interface are driven with the blue color data provided by the LPC3250. The lower blue LCD bit 0 is driven to 0 by the CPLD (since this data bit is not provided by the 16-bit operating mode of the LPC3250). The lower 3 bits of the LPC3250 LCD interface, LCD18, LCD17, and LCD16 are freed for use as their alternative functions when operating in this mode.

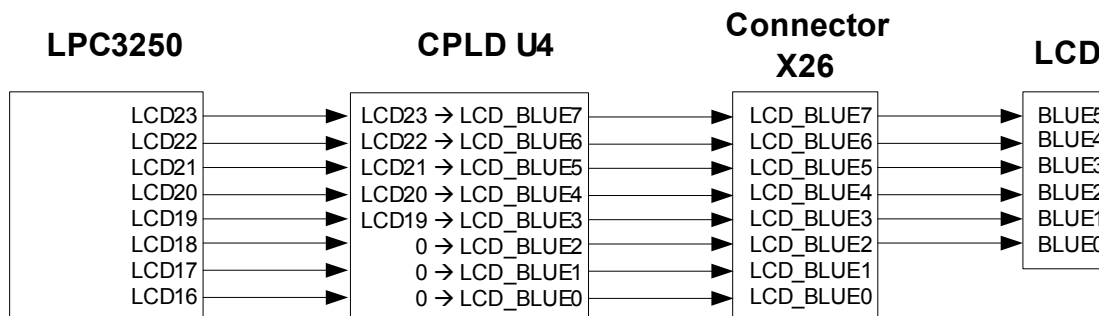

Fig. 27-3. LCD BLUE Signal Mapping in 16-bit Mode with an 18-Bit LCD

Table 28 shows a detailed mapping of the LPC3250 LCD port signals through the CPLD. In general the CPLD is acting as a buffer, mapping LCD23...16 directly to LCD_BLUE7...0, LCD15...8 to LCD_GREEN7...0, and LCD7...0 to LCD_RED7...0. The only time this is not true is for the lower LCD color

bits for 16-bit and 12-bit mode. In the 16-bit modes (5:6:5 and 5:5:5) and 12-bit mode (4:4:4) the unused LCD bits on the LPC3250 LCD port are not buffered through the CPLD. Instead the CPLD holds these signals LOW for these operating modes. The signal mapping is as follows for the four LCD bit modes:

24-bit 8:8:8 mode (JP48,49,50 = CLOSED,CLOSED,CLOSED)

- LCD23...16 → LCD_BLUE7...0
- LCD15...8 → LCD_GREEN7...0
- LCD7...0 → LCD_RED7...0

16-bit 5:6:5 mode (JP48,49,50 = CLOSED,OPEN,CLOSED)

- LCD23...19 → LCD_BLUE7...3
- LCD18...16 → Free for external use
- LCD_BLUE2...0 → Driven LOW
- LCD15...10 → LCD_GREEN7...2
- LCD9...8 → Free for external use
- LCD_GREEN1...0 → Driven LOW
- LCD7...3 → LCD_RED7...3
- LCD2...0 → Free for external use
- LCDRED2...0 → Driven LOW

16-bit 5:5:5 mode (JP48,49,50 = CLOSED,CLOSED,OPEN)

- LCD23...19 → LCD_BLUE7...3
- LCD18...16 → Free for external use
- LCD_BLUE2...0 → Driven LOW
- LCD15...11 → LCD_GREEN7...3
- LCD10...8 → Free for external use
- LCD_GREEN2...0 → Driven LOW
- LCD7...3 → LCD_RED7...3
- LCD2...0 → Free for external use
- LCDRED2...0 → Driven LOW

12-bit 4:4:4 mode (JP48,49,50 = CLOSED,OPEN,OPEN)

- LCD23...18 → LCD_BLUE7...4
- LCD19...16 → Free for external use
- LCD_BLUE3...0 → Driven LOW
- LCD15...12 → LCD_GREEN7...4
- LCD11...8 → Free for external use
- LCD_GREEN3...0 → Driven LOW
- LCD7...4 → LCD_RED7...4
- LCD3...0 → Free for external use
- LCDRED3...0 → Driven LOW

Table 27-1. LPC3250 LCD Port to Buffered CPLD Signal Mapping

| LPC3250 Signal | Buffered CPLD Signal |
|-----------------------|-----------------------------|
| LCD23 | LCD_BLUE7 |
| LCD22 | LCD_BLUE6 |
| LCD21 | LCD_BLUE5 |
| LCD20 | LCD_BLUE4 |
| LCD19 | LCD_BLUE3 |
| LCD18 | LCD_BLUE2 |
| LCD17 | LCD_BLUE1 |
| LCD16 | LCD_BLUE0 |
| LCD15 | LCD_GREEN7 |
| LCD14 | LCD_GREEN6 |
| LCD13 | LCD_GREEN5 |
| LCD12 | LCD_GREEN4 |
| LCD11 | LCD_GREEN3 |
| LCD10 | LCD_GREEN2 |
| LCD09 | LCD_GREEN1 |
| LCD08 | LCD_GREEN0 |
| LCD07 | LCD_RED7 |
| LCD06 | LCD_RED6 |
| LCD05 | LCD_RED5 |
| LCD04 | LCD_RED4 |
| LCD03 | LCD_RED3 |
| LCD02 | LCD_RED2 |
| LCD01 | LCD_RED1 |
| LCD00 | LCD_RED0 |
| LCDFP | LCD_VSYNC |
| LCDLP | LCD_HSYNC |
| LCDCP | LCD_PCLK |
| LCDAC | LCD_DATAVALID |
| LCDLE | LCD_LINE_END |
| LCDCLKIN | LCD_CLKIN |

Table 29 shows a summary of the required jumper settings for each given LPC3250 LCD operating mode.

Table 27-2. LCD Mode Jumper Summary (JP48, JP49, JP50)

| LCD Mode (BGR) | Jumper Settings: JP48, JP49, JP50 |
|-----------------------|--|
| 24-bit 8:8:8 | CLOSED, CLOSED, CLOSED |
| 16-bit 5:6:5 | CLOSED, OPEN, CLOSED |
| 16-bit 5:5:5 | CLOSED, CLOSED, OPEN |
| 12-bit 4:4:4 | CLOSED, OPEN, OPEN |

A detailed list of applicable configuration jumpers and LED indicators is presented below.

- JP40** LCD interface enable control. By default this jumper is set to the 2+3 position, selecting processor signal GPO_0 to control LCD interface enable. Set this jumper to the 1+2 position to permanently disable the LCD interface. Remove this jumper to permanently enable the LCD interface. When this jumper is removed or in the 1+2 position the processor signal GPO_0 becomes free for external use.
- JP48..50** Configures the LCD operating mode. By default these jumpers are set to CLOSED, OPEN, CLOSED resulting in the 16-bit 5:6:5 operating mode. See Table 29 for a detailed list of jumper settings and corresponding operating modes.
- JP51** LCD backlight control jumper. By default this jumper is set to the 2+3 position, selecting processor signal GPO_4 to control LCD backlight. Set this jumper to the 1+2 position to permanently turn off the LCD backlight. Remove this jumper to permanently turn on the LCD backlight. When this jumper is removed or in the 1+2 position the processor signal GPO_4 becomes free for external use.
- D17** LCD 5.0V status indicator. When illuminated the 5.0V supply to the LCD connector X26 is active.
- D34** LCD 3.3V status indicator. When illuminated the 3.3V supply to the LCD connector X26 is active.

28 GPIO Expansion Connector

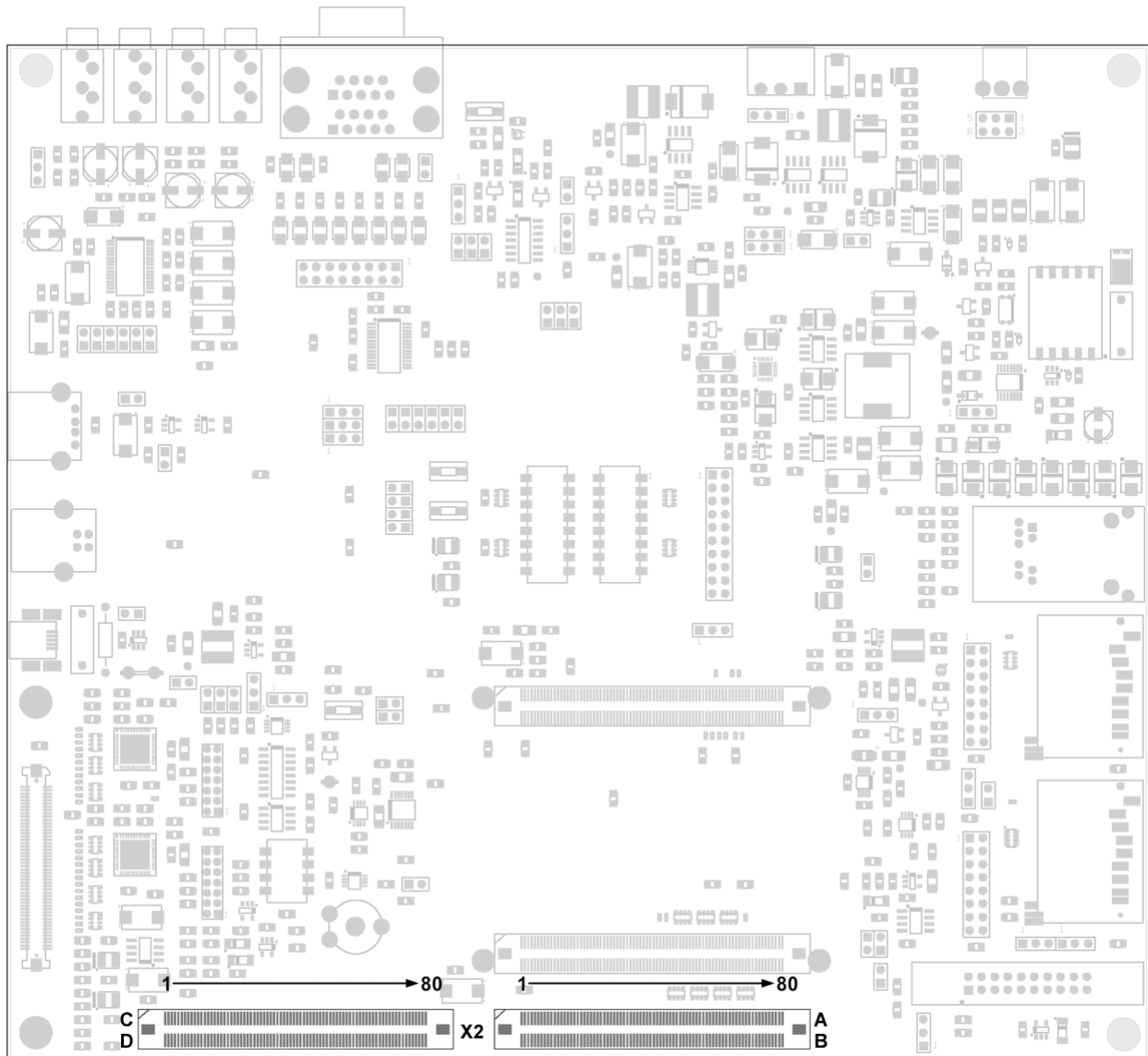

Fig. 28-1. GPIO Expansion Connector

The GPIO expansion port connector X2 provides a 1:1 mapping of most of the phyCORE-LPC3250 mating connector X1 signals. Additional signals generated on the Carrier Board are also routed to the GPIO expansion port connector X2. As an accessory a GPIO expansion board (part # PCM-988) is made available through PHYTEC to mate with the X2 connector on the phyCORE-LPC3250 Carrier Board. This expansion board provides a patch field for easy access to all signals, and additional board space for testing and prototyping. A summary of the signal mappings between X1, X2, and the patch field on the GPIO expansion board is provided in [Part III](#).

29 RS-232 Connectivity

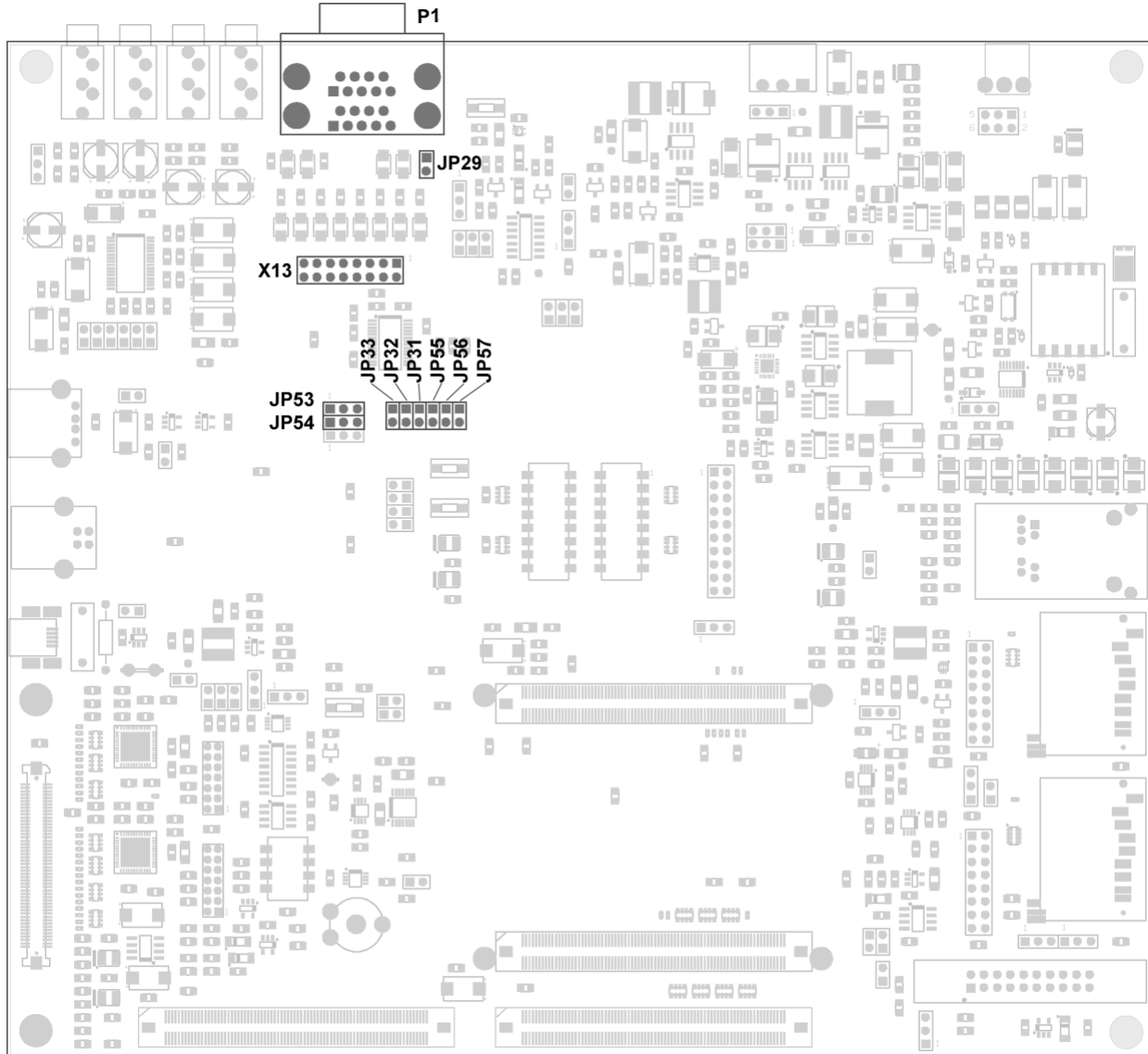

Fig. 29-1. RS-232 Interface Connectors and Jumpers

Female DB-9 connectors P1A and P1B provide connectivity to the phyCORE-LPC3250 UART2, UART3, and UART5 interfaces at RS-232 levels. Connector P1A is dedicated to UART5, while P1B is shared between UART2 and UART3. In addition to the traditional DB-9 style connectors a 0.1"/2.54mm header at X13 is provided for easy access the UART2 and UART3 signals at RS-232 levels.

Figure 29-2 shows the pin numbering for the DB-9 connectors, while Table 29-1 and Table 29-2 give a detailed description of the signals at P1A and P1B.

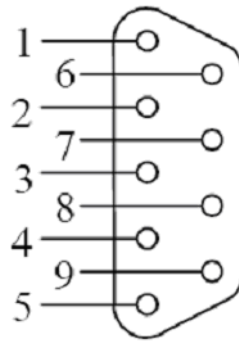

Fig. 29-2. DB-9 RS-232 Connectors P1A and P1B Pin Numbering

Table 29-1. Connector P1A (UART5) Pin Descriptions

| Pin | Signal | I/O | Description |
|-----|-------------|-----|----------------|
| 1 | N/C | - | Not connected |
| 2 | U5_TX_RS232 | O | UART5 transmit |
| 3 | U5_RX_RS232 | I | UART5 receive |
| 4 | N/C | - | Not connected |
| 5 | GND | - | Ground |
| 6 | N/C | - | Not connected |
| 7 | N/C | - | Not connected |
| 8 | N/C | - | Not connected |
| 9 | N/C | - | Not connected |

Table 29-2. Connector P1B (UART3 and UART2) Pin Descriptions

| Pin | Signal | I/O | Description |
|-----|----------------|-----|---------------------------|
| 1 | U3_DCD_RS232 | I | UART3 Data Carrier Detect |
| 2 | U3/U2_TX_RS232 | O | UART3/UART2 Transmit |
| 3 | U3/U2_RX_RS232 | I | UART3/UART2 Receive |
| 4 | U3_DSR_RS232 | I | UART3 Data Set Ready |
| 5 | GND | - | Ground |
| 6 | U3_DTR_RS232 | O | UART3 Data Terminal Ready |
| 7 | U3_CTS_RS232 | I | UART3/UART2 Clear To Send |
| 8 | U3_RTS_RS232 | O | UART3/UART2 Ready To Send |
| 9 | U3_RI_RS232 | I | UART3 Ring Indicator |

Figure 29-3 shows a detailed pin number at the UART3/UART2 header connector X13. Pin number 1 can be found by looking for a 1 on the PCB silk screen next to connector X13.

Table 29-3 provides a detailed description of the signals at header connector X13.

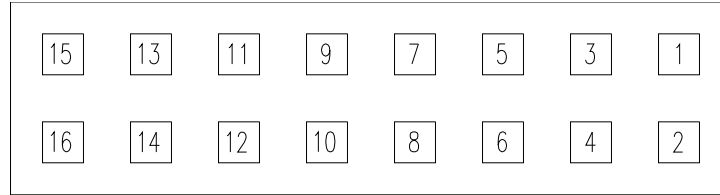

Fig. 29-3. UART3/UART2 Header Connector X13 Pin Numbering

Table 29-3. UART3/UART2 Header Connector X13 Pin Descriptions

| Pin | Signal | I/O | Description |
|-----|---------------------------|-----|-----------------------------|
| 1 | U3RI_RS232 | I | UART3 Ring Indicator |
| 2 | U3DSR_RS232 | I | UART3 Data Set Ready |
| 3 | U3RTS_RS232 | O | UART3/UART2 Ready To Send |
| 4 | U3RX_RS232 | I | UART3/UART2 Receive |
| 5 | U3TX_RS232 | O | UART3/UART2 Transmit |
| 6 | U3CTS_RS232 | I | UART3/UART2 Clear To Send |
| 7 | U3DTR_RS232 | O | UART3 Data Terminal Ready |
| 8 | U3DCD_RS232 | I | UART3 Data Carrier Detect |
| 9 | GND | - | Ground |
| 10 | GND | - | Ground |
| 11 | GND | - | Ground |
| 12 | GND | - | Ground |
| 13 | /U3_INVALID ^a | O | UART3 Invalid Output |
| 14 | U3_FORCEON ^a | I | UART3 Force On Input |
| 15 | /U3_FORCEOFF ^a | I | UART3 Force Off Input |
| 16 | U3_RI_DETECT ^a | O | UART3 Ring Indicator Detect |

a. See the Maxim IC MAX3245EAI datasheet for details on these signals.

In addition to the three access connectors 9 configuration jumpers are provided to configure the RS-232 interface, or free up signals for alternative use. A detailed list of applicable configuration jumpers is presented below.

- JP29** Shuts down the RS-232 transceiver on the phyCORE-LPC3250. By default this jumper is in the OPEN position. Close this jumper to reduce system power if the RS-232 interface is not needed.
- JP31** Connects U3_RTS signal to the MAX3245 RS-232 transceiver. By default this jumper is in the CLOSED position, enabling RS-232 communication. Open this jumper to free up U3_RTS for external use.

- JP32** Connects U3_CTS signal to the MAX3245 RS-232 transceiver. By default this jumper is in the CLOSED position, enabling RS-232 communication. Open this jumper to free up the U3_CTS signal for external use.
- JP33** Connects U3_DCD signal to the MAX3245 RS-232 transceiver. By default this jumper is in the CLOSED position, enabling RS-232 communication. Open this jumper to free up the U3_DCD signal for external use.
- JP53** Controls UART3 and UART2 TX routing to connector P1B. By default this jumper is set to the 1+2 position, routing the UART3_TX_RS232 transmit signal to the transmit pin of the DB-9 connector P1B. Set this jumper to the 2+3 position to route the UART2 transmit signal (multiplexed with the U3_DTR_RS232 signal) to the transmit pin of connector P1B.
- JP54** Controls UART3 and UART2 RX routing to connector P1B. By default this jumper is set to the 1+2 position, routing the UART3_RX_RS232 receive signal to the receive pin of the DB-9 connector P1B. Set this jumper to the 2+3 position to route the UART2 receive signal (multiplexed with the U3_DSR_RS232 signal) to the receive pin of connector P1B.
- JP55** Connects U3_DSR signal to the MAX3245 RS-232 transceiver. By default this jumper is in the CLOSED position, enabling RS-232 communication. Open this jumper to free up the U3_DSR signal for external use.
- JP56** Connects U3_RI signal to the MAX3245 RS-232 transceiver. By default this jumper is in the CLOSED position, enabling RS-232 communication. Open this jumper to free up the U3_RI signal for external use.
- JP57** Connects U3_RX signal to the MAX3245 RS-232 transceiver. By default this jumper is in the CLOSED position, enabling RS-232 communication. Open this jumper to free up the U3_RX signal for external use.

Table 29-4 provides a summary of the jumper configuration settings required for configuring DB-9 connector P1B for UART3 operation and for UART2 operation. Be aware that UART3 and UART2 are multiplexed on the same physical pins on the LPC3250. Because the RX and TX pins are not multiplexed onto the same pins (e.g., UART3_TX and UART2_TX are not multiplexed on the same pin), configuration jumpers are required to route the appropriate RX/TX signals to the RX/TX pins of the DB-9 connector P1B.

Table 29-4. Configuring DB-9 Connector P1B for UART3 or UART2 Operation

| Configuration | Jumper Setting | Description |
|-----------------|----------------|---|
| UART3 Operation | JP53 = 1 + 2 | UART3 transmit signal UART3_TX_RS232 routed to the transmit pin of DB-9 connector P1B. |
| | JP54 = 1 + 2 | UART3 receive signal UART3_RX_RS232 routed to the receive pin of DB-9 connector P1B. |
| UART2 Operation | JP53 = 2 + 3 | UART2 transmit signal UART3_DTR_RS232 routed to the transmit pin of the DB-9 connector P1B. |
| | JP54 = 2 + 3 | UART2 receive signal UART3_DSR_RS232 routed to the receive pin of the DB-9 connector P1B. |

Note that the UART3 and UART2 CTS and RTS signals are multiplexed on the same pins and do not need to be rerouted as do the transmit and receive signals. That is, UART3 RTS is also UART2 HRTS, and UART3 CTS is also UART2 HCTS.

30 SD/MMC Connectivity

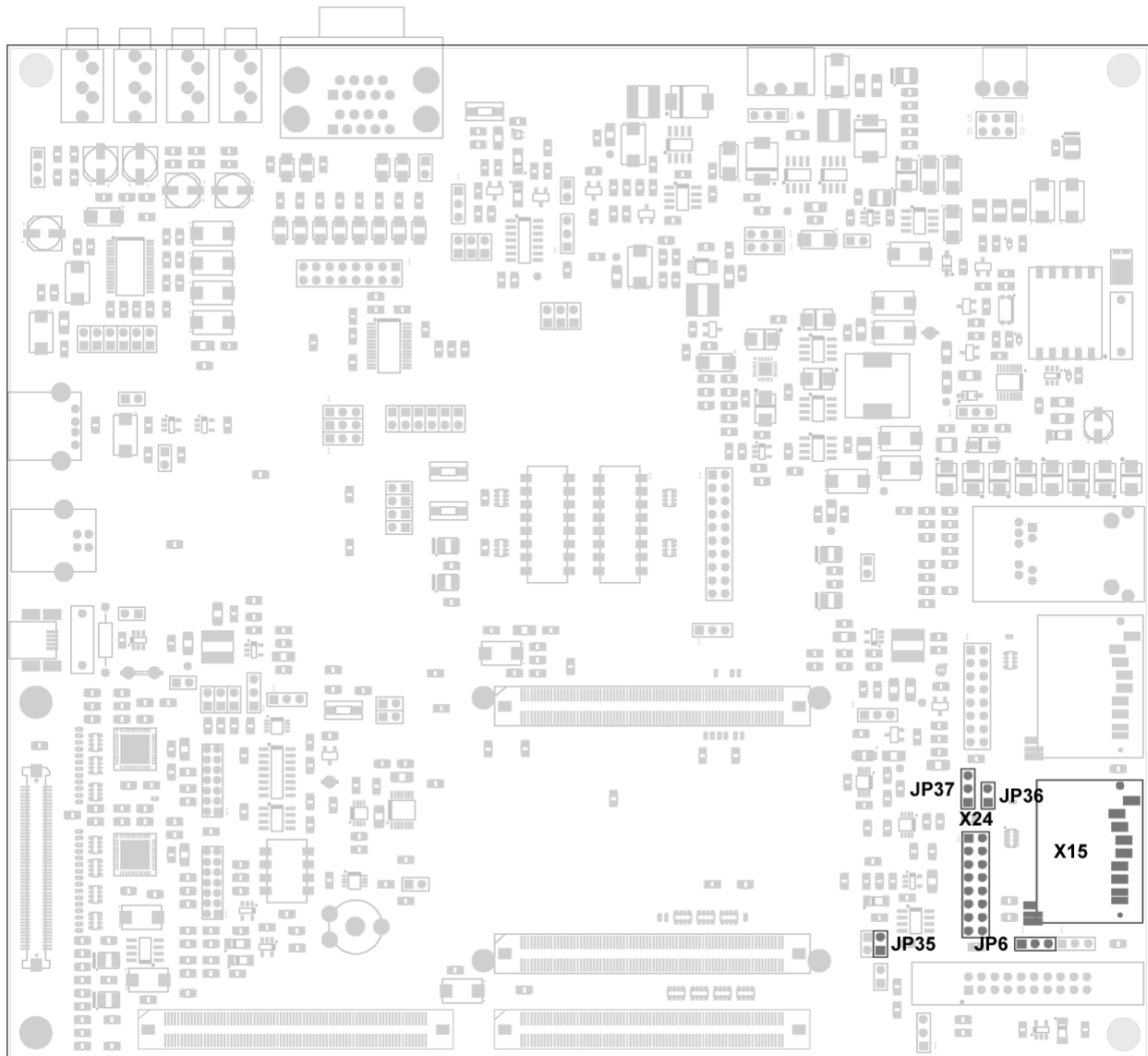

Fig. 30-1. SD/MMC Interface Connectors and Jumpers

Connector X15 provides connectivity to the phyCORE-LPC3250's SD/MMC card interface. In addition header connector X24 has been provided for easy access to the SD/MMC card signals for probing purposes.

A slew rate limited 3.15V power supply capable of supplying 200mA of current has been provided for dynamic power control to the connected SD/MMC card. The power circuit is controlled via processor signal GPO_5. Set GPO_5 HIGH to turn the SD/MMC power ON and LOW to turn the SD/MMC power OFF.

Several configuration jumpers are provided for control of the SD/MMC interface. A detailed list of applicable configuration jumpers is presented below.

- JP6** Selects the SD/MMC power source. By default this jumper is set to the 1+2 position, providing dynamic control of the SD/MMC slot power via processor signal GPO_5. Set this jumper to the 2+3 position to permanently enable SD/MMC slot power.
- JP35** Connects the buffered processor signal tGPO_5 to the SD/MMC power control circuit. By default this jumper is set to the CLOSED position, enabling processor control over the SD/MMC power supply. Set this jumper to the OPEN position to free up GPO_5 for external use. If SD/MMC card access is still required, JP6 should be set to the 2+3 position to permanently enable SD/MMC slot power.
- JP36** Connects processor signal GPIO_1 to the SD/MMC card detect output. By default this jumper is set to the CLOSED position, enabling the processor to detect SD/MMC card presence. Set this jumper to the OPEN position to free up the GPIO_1 signal for external use.
- JP37** Connects the processor signal GPIO_0 to either the SD/MMC card write protect output, or the processor signal MS_DIO1. By default this jumper is set to the 1+2 position, enabling the processor to detect the SD/MMC card write protect state. Set this jumper to the 2+3 position when using the SD/MMC card slot with SDIO devices. Remove this jumper to free up GPIO_0 for external use.

31 SDIO Connectivity

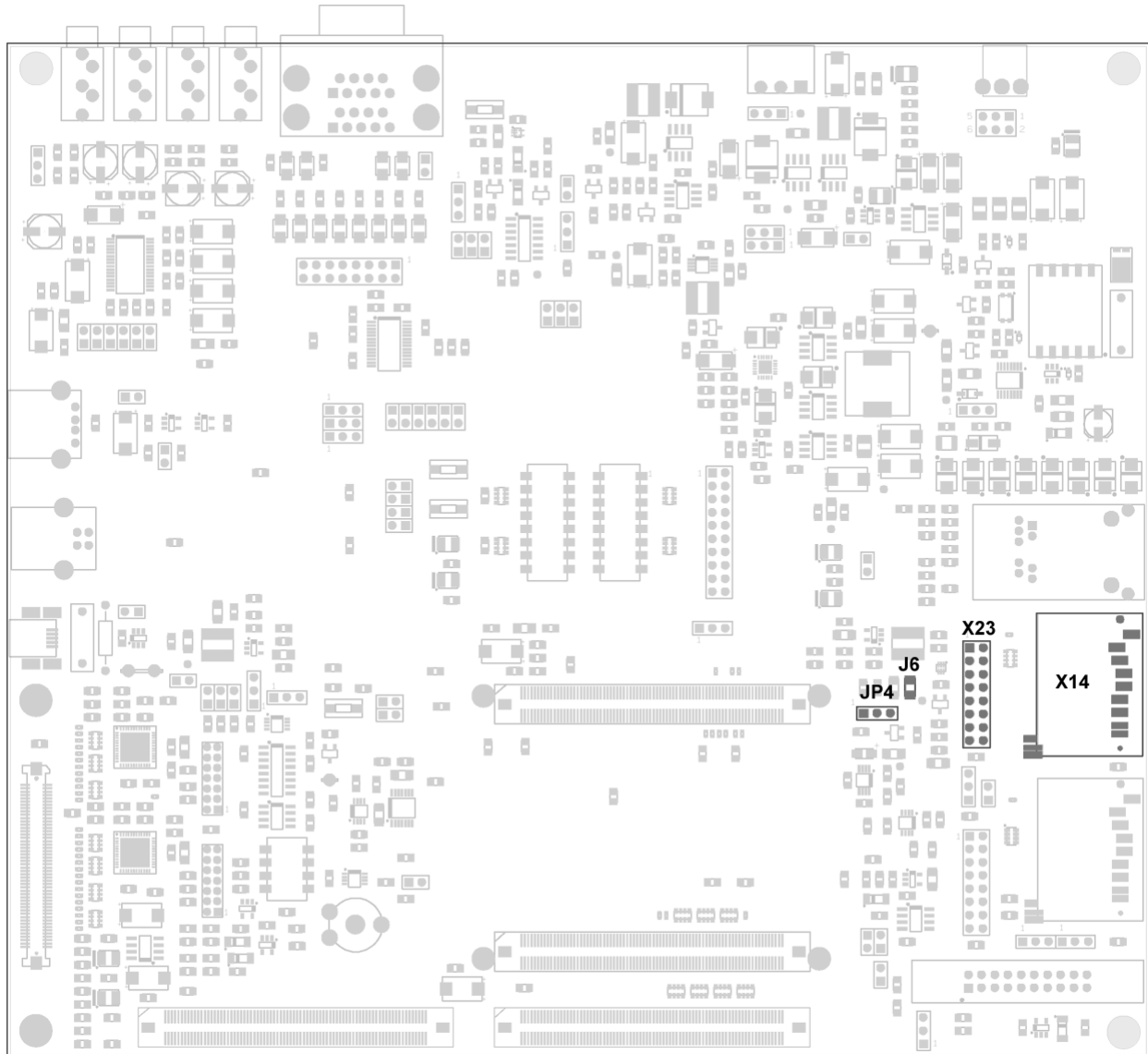

Fig. 31-1. SDIO Interface Connectors and Jumpers

Connector X14 provides connectivity to the phyCORE-LPC3250's SDIO controller interface. In addition header connector X23 has been provided for easy access to the SDIO card signals for probing purposes.

Pin 1 of connector X23 is marked with a square pad in [Figure 31-1](#). In addition the PCB silk screen marks pin with a '1' next to the pin. Pins on the left in [Figure 31-1](#) are odd numbered while pins on the right are even numbered. [Table 31-1](#) shows the signal locations and descriptions on the connector.

Table 31-1. SDIO Easy Access Header Connector X23 Signal Descriptions

| Pin # | Signal | I/O | Description |
|-------|---------------|-----|---|
| 1 | SDIO_D2 | I/O | Data I/O signal D2 |
| 2 | SDIO_D3 | I/O | Data I/O signal D3 |
| 3 | SDIO_CMD | I/O | Command/response I/O signal |
| 4 | SDIO_CLK | O | Clock output |
| 5 | SDIO_D0 | I/O | Data I/O signal D0 |
| 6 | SDIO_D1 | I/O | Data I/O signal D1 |
| 7 | SDIO_D4 | I/O | Data I/O signal D4 |
| 8 | SDIO_D5 | I/O | Data I/O signal D5 |
| 9 | SDIO_D6 | I/O | Data I/O signal D6 |
| 10 | SDIO_D7 | I/O | Data I/O signal D7 |
| 11 | SDIO_POW0 | I/O | Power control output signal 0 |
| 12 | SDIO_POW1 | O | Power control output signal 1 |
| 13 | /SDIO_CD | I | Card detect input |
| 14 | /SDIO_WP | I | Write protect input |
| 15 | GND | - | Ground |
| 16 | VCC_SDIO SLOT | - | Card power signal (either 1.8V, 3.15V, or 3.3V depending on POW0/1 and JP4) |

The adjustable switching supply located at U19 has been provided to facilitate connecting to low and high powered SDIO devices. The supply is adjustable between a low voltage setting and a high voltage setting, controlled by the SDIO POW0 and POW1 signals. The low voltage setting is fixed at 1.8V, while the high voltage setting is jumper adjustable between 3.15V and 3.3V.

A detailed description of the voltage configuration jumper along with other applicable SDIO connectivity components is presented below.

JP4 Controls the high voltage setting for the SDIO card supply. By default this jumper is set to 1+2, configuring the SDIO card supply for 3.15V. Alternatively this jumper can be set to the 2+3 position to configure the SDIO card supply for 3.3V. In most cases 3.15V will be acceptable, however, some SDIO devices may have a narrow 3.3V operating voltage, in which case the 3.3V setting becomes appropriate.

J6 Current measurement access point. Replace this 0R jumper with a precision shunt resistor to measure current consumption at the SDIO interface. Note that the current measurement at this location is the sum of the current drawn by the SDIO controller on the phyCORE-LPC3250, and the device attached to the SDIO connector X14.

X14 SD/MMC style card connector.

X23 16-pin easy access signal header.

32 Keyboard Connectivity

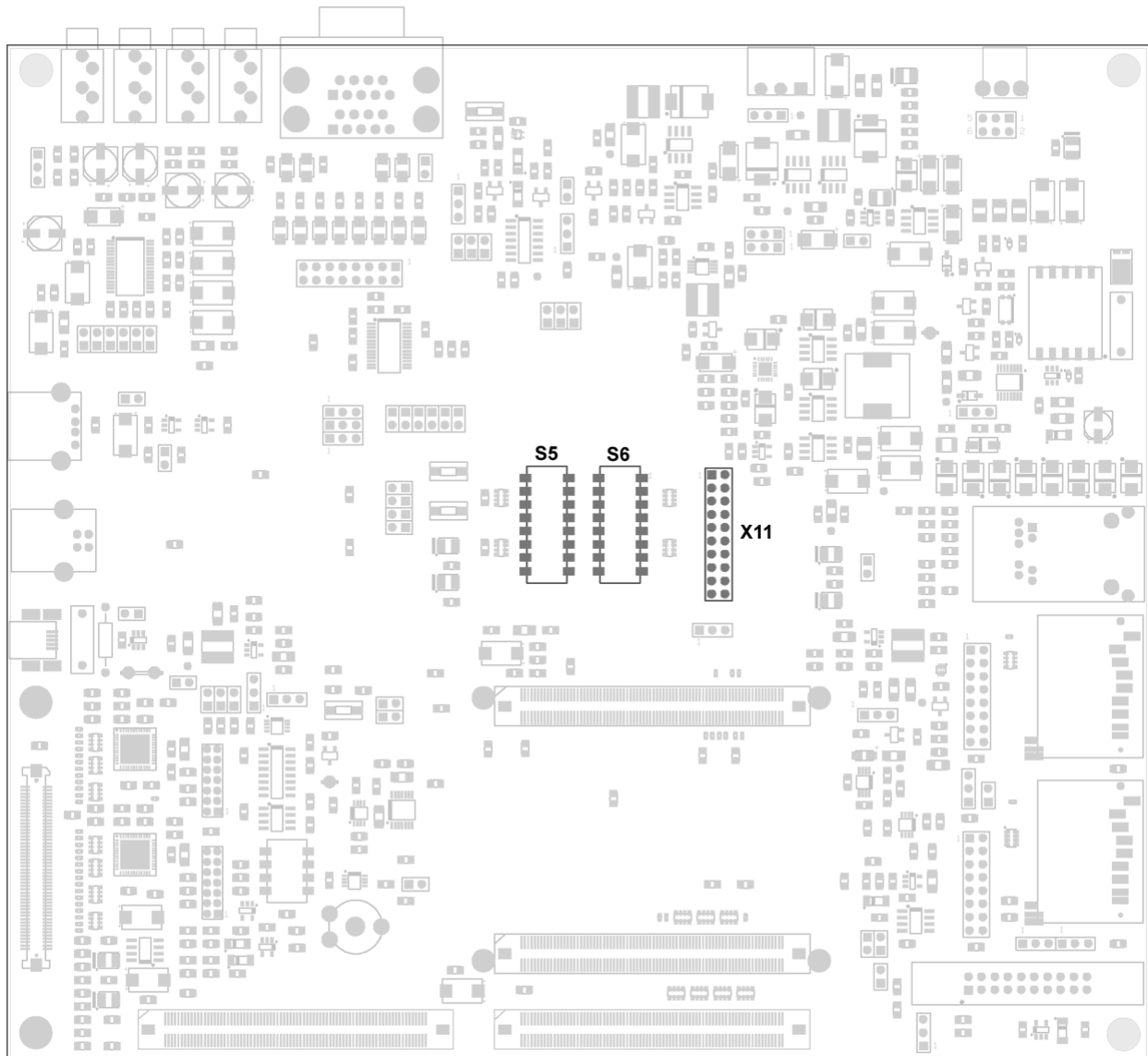

Fig. 32-1. Keyboard Interface Connector and Dip Switches

The phyCORE-LPC3250 Carrier Board provides an easy access 0.1"/2.54mm header connector at X11 to the keyboard port pins. In addition two sets of dip switches are provided to add the necessary 1M pull-up, and 22k pull-down resistors as illustrated in the LPC3250 User's Manual.

The Ethernet interface must be manually disabled when using the keyboard interface. This is due to the multiplexing of the controller's Ethernet pins and keyboard pins. Refer to [Chapter 10.2](#) for information on disabling the Ethernet interface prior to keyboard access. If the Ethernet interface is not properly disabled the SOM on-board pull-up/down resistors, and Ethernet PHY internal pull-up/down resistors will adversely affect keyboard operation.

[Figure 32-1](#) shows a detailed view of the location of the access header and dip switches. Close the appropriate switch to add the 1M or 22k pull-up/down resistors, and open the appropriate switch to remove the pull-up/down resistor. Switch S5 controls the 1M pull-ups, while S6 controls the 22k pull-downs.

Table 32-1 and Table 32-2 show the relationship between the switch positions and the associated keyboard signals.

Table 32-1. Dip Switch S5 Positions and Associated Signals

| Switch Position | Associated Signal |
|-----------------|-----------------------|
| 1 | ENET_MDIO/KEY_ROW7 |
| 2 | ENET_MDC (KEY_ROW6) |
| 3 | ENET_TXD1 (KEY_ROW5) |
| 4 | ENET_TXD0 (KEY_ROW4) |
| 5 | ENET_TX_EN (KEY_ROW3) |
| 6 | ENET_TXD3 (KEY_ROW2) |
| 7 | ENET_TXD2 (KEY_ROW1) |
| 8 | ENET_TX_ER (KEY_ROW0) |

Table 32-2. Dip Switch S6 Positions and Associated Signals

| Switch Position | Associated Signal |
|-----------------|-------------------------|
| 1 | ENET_COL (KEY_COL7) |
| 2 | ENET_RX_DV (KEY_COL6) |
| 3 | ENET_RXD1 (KEY_COL5) |
| 4 | ENET_RXD0 (KEY_COL4) |
| 5 | ENET_CRS (KEY_COL3) |
| 6 | ENET_RX_ER (KEY_COL2) |
| 7 | ENET_REF_CLK (KEY_COL1) |
| 8 | ENET_TX_CLK (KEY_COL0) |

Table 32-3 provides a detailed description of the easy access header connector X11 signals. When referencing pin numbers note that pin 1 is marked with a square pad in Figure 32-1 and with a “1” on the PCB silk screen. Pins on the left are odd numbered while pins on the right are even numbered.

Table 32-3. Ethernet/Keyboard Easy Access Header Connector X11 Signal Descriptions

| Pin # | Signal | I/O | Description |
|-------|--------------|-----|--|
| 1 | ENET_TX_ER | O | Ethernet transmit error output/Keyboard ROW0 output |
| 2 | ENET_TX_CLK | I | Ethernet transmit clock input/Keyboard COL0 input |
| 3 | ENET_TXD2 | O | Ethernet transmit data 2 output/Keyboard ROW1 output |
| 4 | ENET_REF_CLK | I | Ethernet reference clock input/Keyboard COL1 input |
| 5 | ENET_TXD3 | O | Ethernet transmit data 3 output/Keyboard ROW2 output |
| 6 | ENET_RX_ER | I | Ethernet receive error input/Keyboard COL2 input |
| 7 | ENET_TX_EN | O | Ethernet transmit enable output/Keyboard ROW3 output |
| 8 | ENET_CRS | I | Ethernet carrier sense input/Keyboard COL3 input |
| 9 | ENET_TXD0 | O | Ethernet transmit data 0 output/Keyboard ROW4 output |
| 10 | ENET_RXD0 | I | Ethernet receive data 0 input/Keyboard COL4 input |

Table 32-3. Ethernet/Keyboard Easy Access Header Connector X11 Signal Descriptions

| Pin # | Signal | I/O | Description |
|-------|------------|-----|--|
| 11 | ENET_TXD1 | O | Ethernet transmit data 1 output/Keyboard ROW5 output |
| 12 | ENET_RXD1 | I | Ethernet receive data 1 input/Keyboard COL5 input |
| 13 | ENET_MDC | O | Ethernet MIIM clock output/Keyboard ROW6 output |
| 14 | ENET_RX_DV | I | Ethernet receive data valid/Keyboard COL6 input |
| 15 | ENET_MDIO | I/O | Ethernet MI data input/output/Keyboard ROW7 output |
| 16 | ENET_COL | I | Ethernet collision detect input/Keyboard COL7 input |
| 17 | ENET_RXD3 | I | Ethernet receive data 3 input |
| 18 | ENET_RXD2 | I | Ethernet receive data 2 input |
| 19 | GND | - | Ground |
| 20 | GND | - | Ground |

33 User Buttons

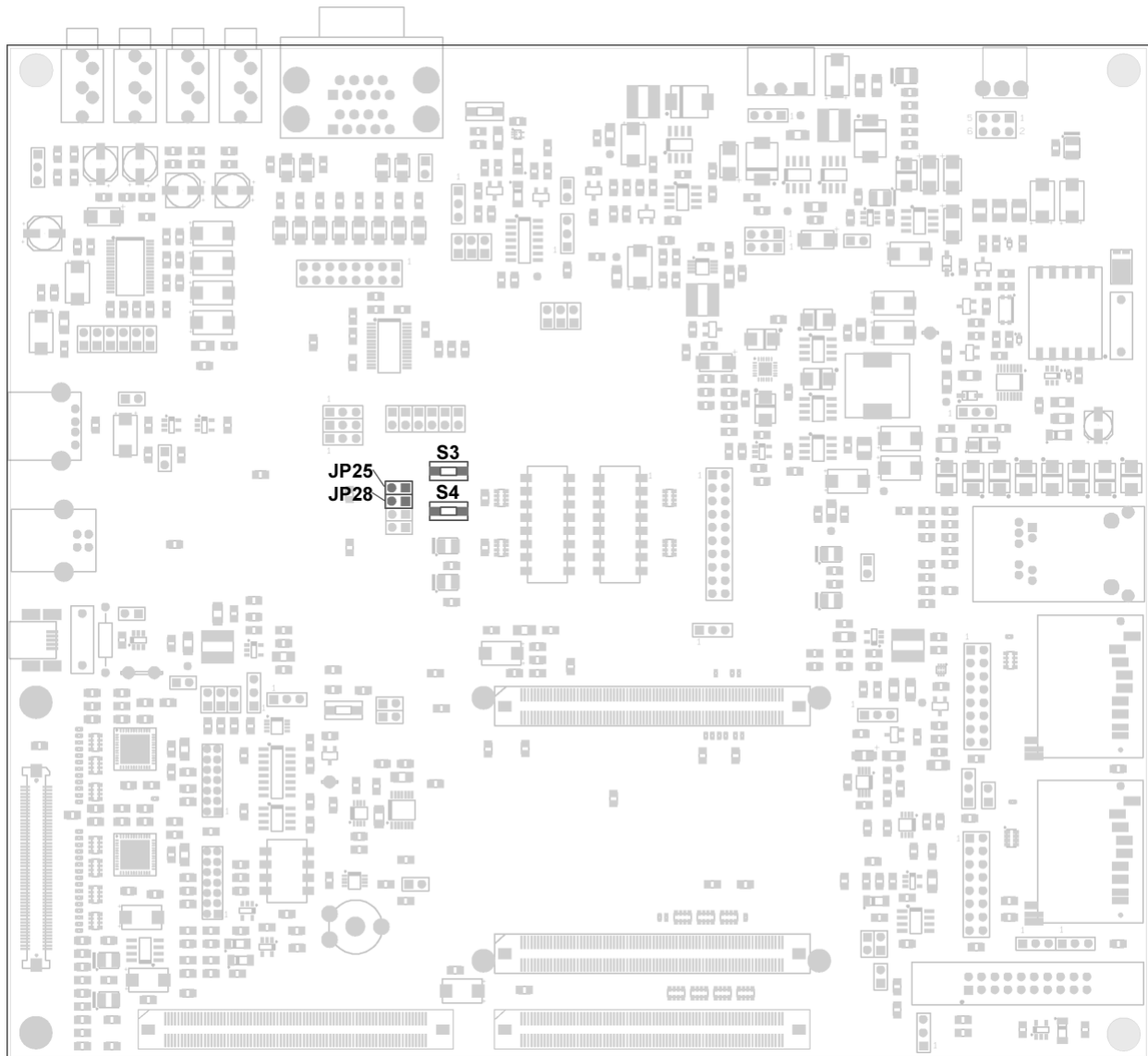

Fig. 33-1. User Buttons and Jumpers

Two users buttons are provided for development purposes. [Figure 33-1](#) shows the location of the user buttons and associated configuration jumpers. The configuration jumpers allow disconnection of the button outputs from the processor GPI signals. A detailing of the buttons and configuration jumpers is presented below.

- S3** User button 1 (labeled as BTN1). Pressing this button generates a debounced, active HIGH going pulse to processor signal GPI_3 for the duration of the press. Holding this button will keep the output to GPI_3 held HIGH. Releasing this button will keep the output to GPI_3 held LOW.

- S4** User button 2 (labeled as BTN2). Pressing this button generates a debounced, active HIGH going pulse to processor signal GPI_2 for the duration of the press. Holding this button will keep the output to GPI_2 held HIGH. Releasing this button will keep the output to GPI_2 held LOW.
- JP25** Connects the output of BTN1 (S3) to processor signal GPI_3. By default this jumper is closed, connecting BTN1 to GPI_3. Open this jumper if GPI_3 is needed for external use.
- JP28** Connects the output of BTN2 (S4) to processor signal GPI_2. By default this jumper is closed, connecting BTN2 to GPI_2. Open this jumper if GPI_2 is needed for external use.

34 User LEDs

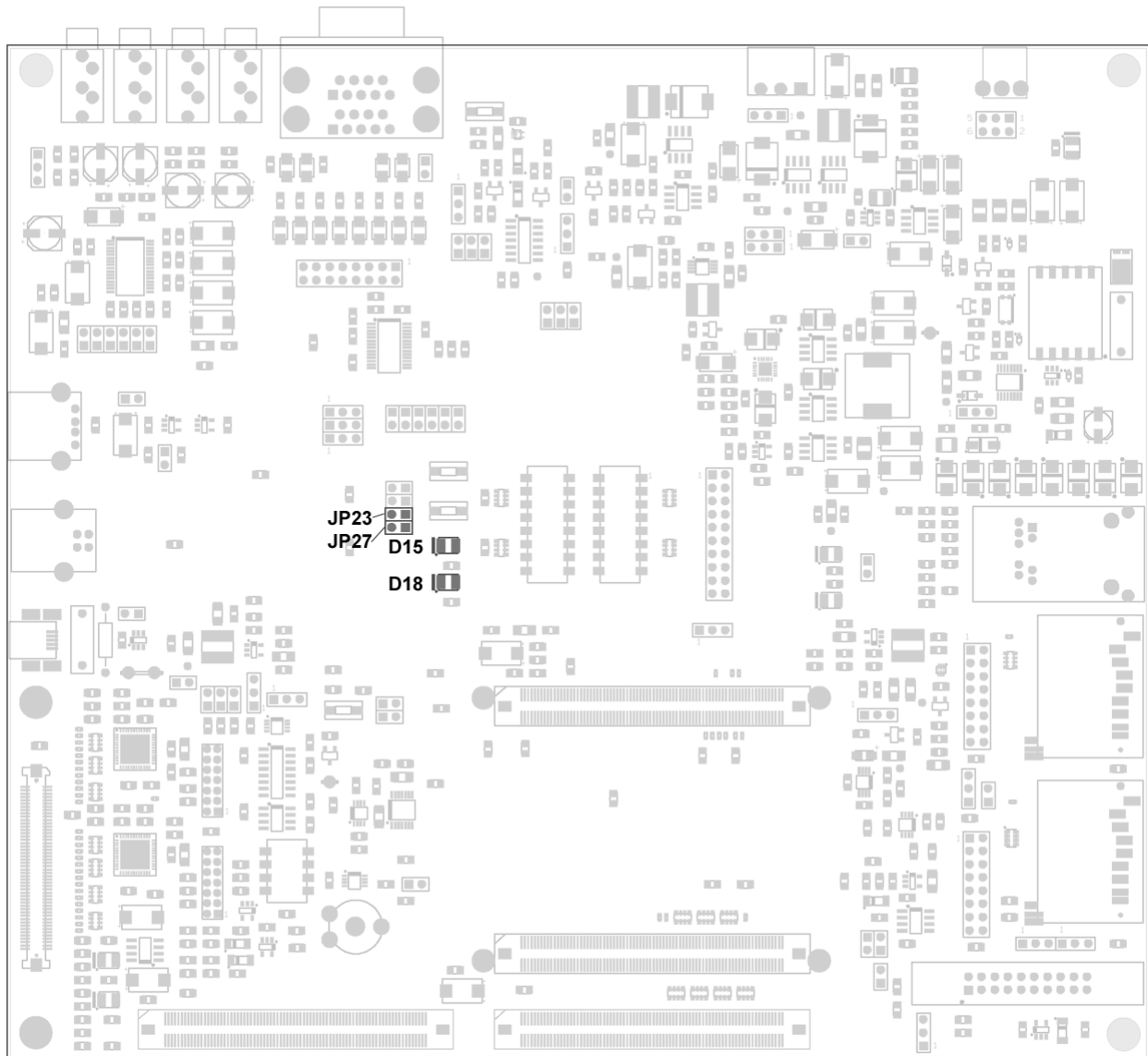

Fig. 34-1. User LEDs and Jumpers

Two user LEDs are provided for development purposes. [Figure 34-1](#) shows the location of the User LEDs and associated jumpers. The configuration jumpers allow disconnection of the LED inputs from the processor GPO signals. A detailing of the LEDs and configuration jumpers is presented below.

- D15** Red User LED 1 (labeled as LED1). Drive processor signal GPO_1 HIGH to turn this LED on and LOW to turn this LED off.
- D18** Red User LED 2 (labeled as LED2). Drive processor signal GPO_14 HIGH to turn this LED on and LOW to turn this LED off.

- JP23** Connects the processor signal GPO_1 to the User LED 1 input. By default this jumper is closed, allowing the processor to control LED 1 via GPO_1. Open this jumper to prevent LED 1 from toggling if GPO_1 needs to be used externally.
- JP27** Connects the processor signal GPO_14 to the User LED 2 input. By default this jumper is closed, allowing the processor to control LED 2 via GPO_14. Open this jumper to prevent LED 2 from toggling if GPO_14 needs to be used externally.

35 User ADC Potentiometer

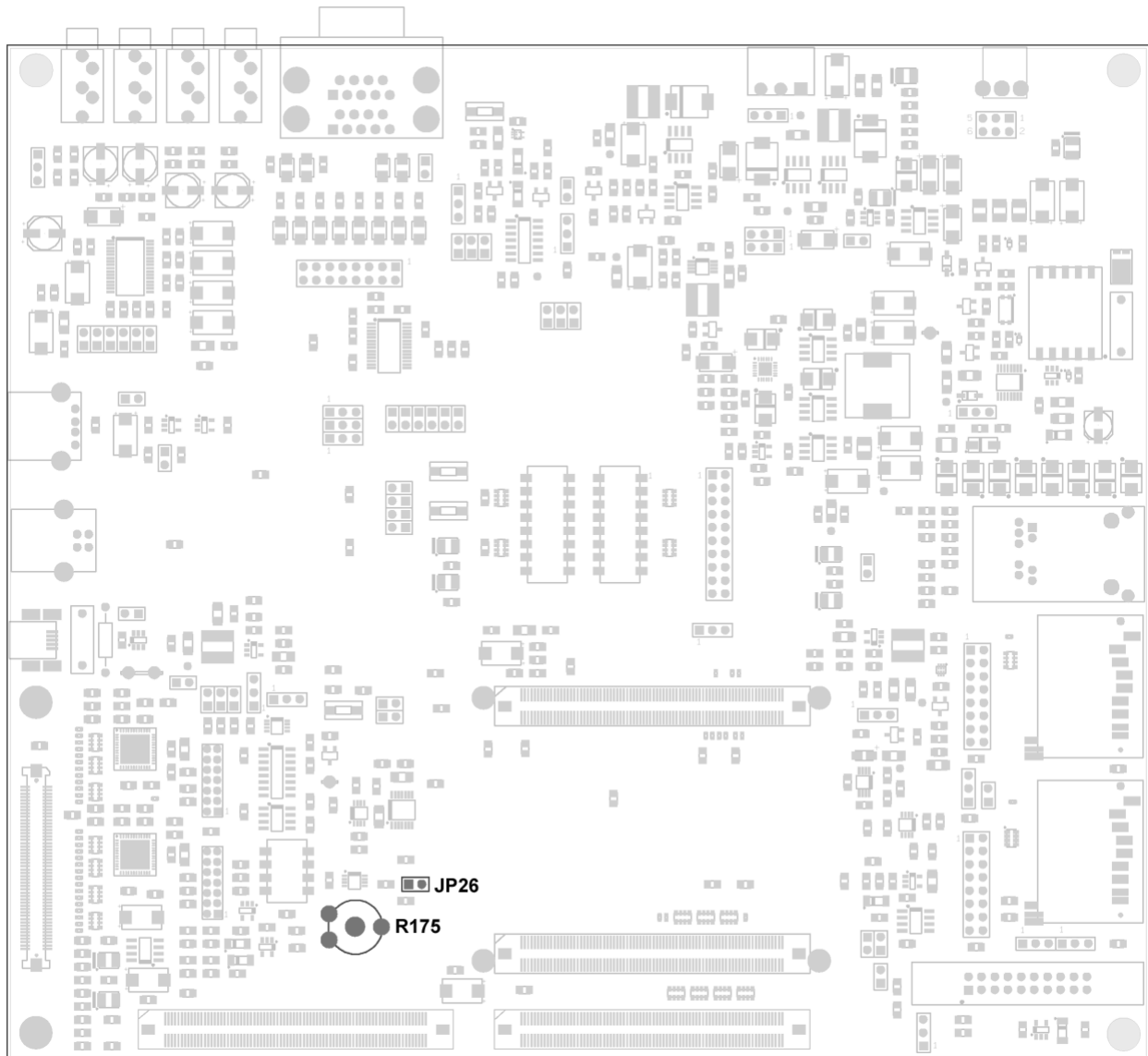

Fig. 35-1. User ADC Potentiometer and Jumper

A 25k potentiometer is provided to demonstrate the LPC3250 analog to digital converter. [Figure 35-1](#) shows the location of the potentiometer and associated configuration jumper. A detailing of the potentiometer and configuration jumper is presented below.

- R175** User ADC potentiometer (labeled as ADC POT). The wiper of this potentiometer is connected to the processor's ADIN2 analog input. The output of the wiper ranges from 0 to 3.15V to match the ADC reference voltage. Therefore an output voltage of 3.15V will read as the hex value 0x3ff (10-bit ADC).
- JP26** Connects the processor's analog-to-digital converter ADIN2 channel to the output of the User ADC potentiometer R175. By default this jumper is closed, connecting the pot to the ADIN2 input. Open this jumper if the ADIN2 input is needed for external use.

36 Boot Mode Selection

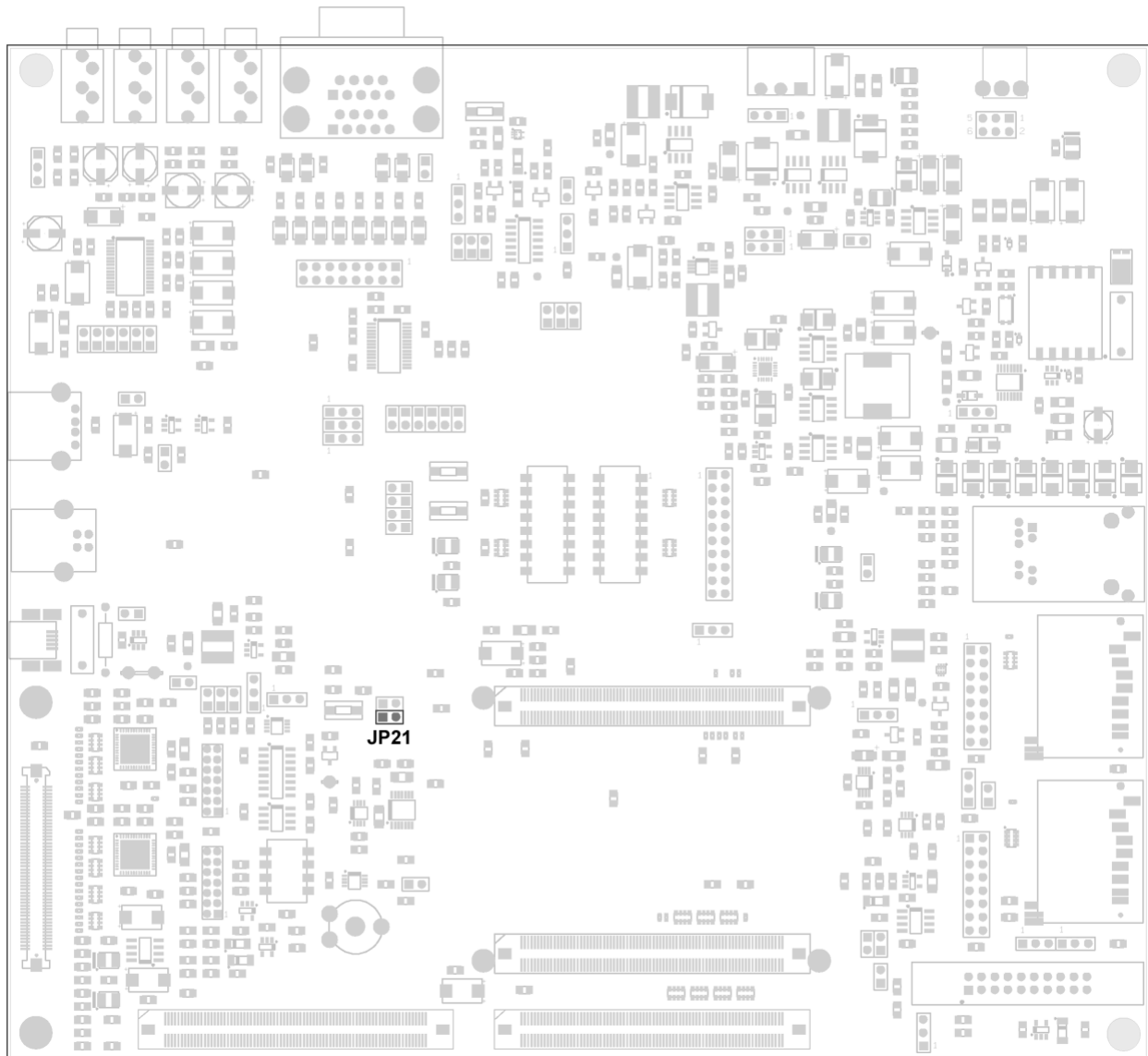

Fig. 36-1. Boot Mode Selection Jumper

The boot mode jumper JP21 is provided to configure the boot mode after a reset.

By default the boot mode jumper is closed, configuring the phyCORE-LPC3250 for UART5 boot. Alternatively JP21 can be removed, resulting the normal boot mode.

In the normal boot mode the processor attempts a SPI boot, followed by a boot from the external memory bus, followed by a NAND flash boot. When configured for UART5 boot the on-chip boot strap software will continue with a normal boot if the UART5 boot process fails. See the NXP LPC3250 User's Manual for details on the LPC3250 boot procedure associated. When referencing the NXP manual note that the boot jumper JP21 sets the SERVICE_N signal LOW when closed, and HIGH when open.

37 System Reset Button

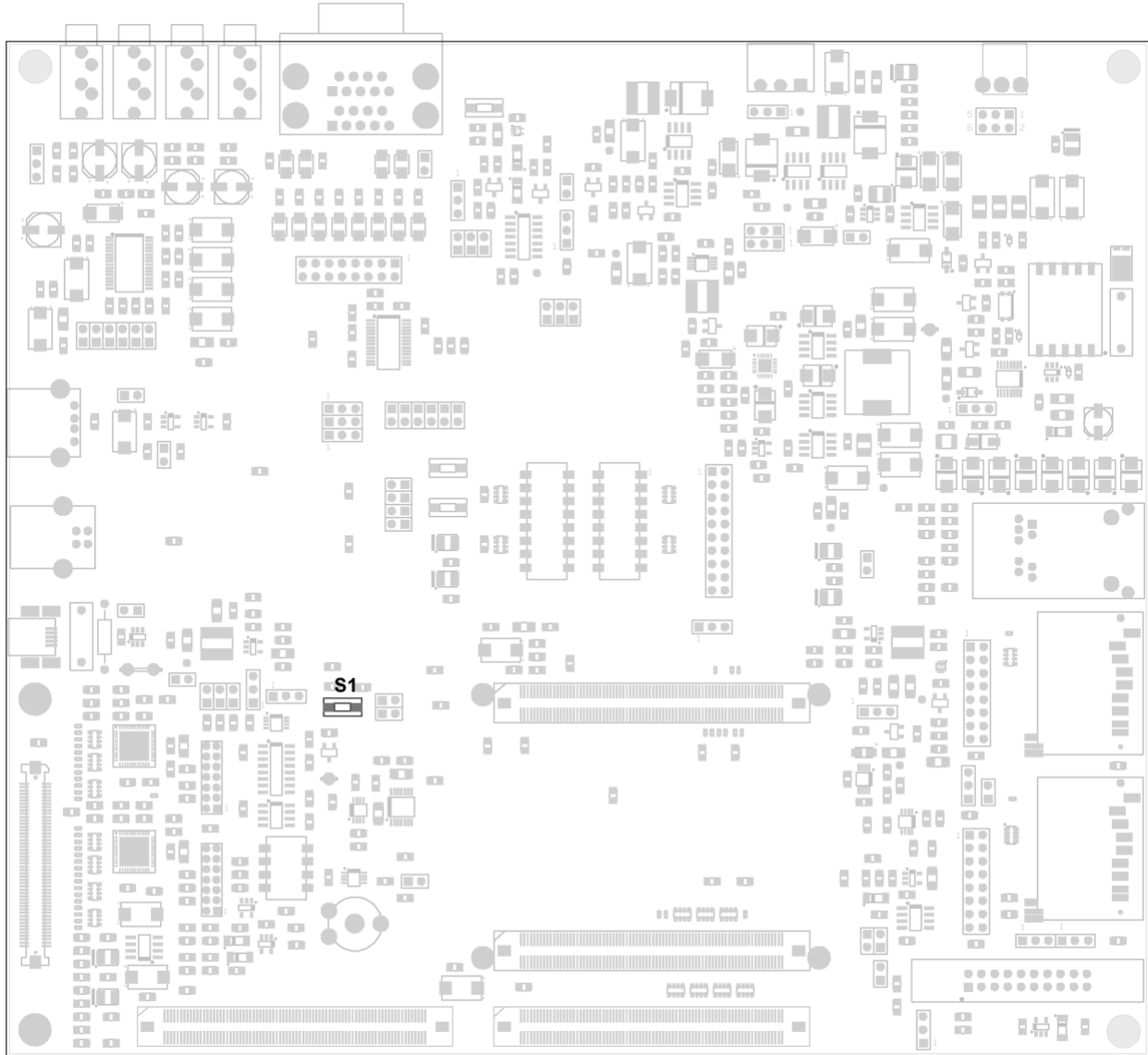

Fig. 37-1. System Reset Button

A system reset button is provided to reset the processor and its peripherals. Figure 41 shows the position of the reset button on the Carrier Board.

Momentarily pressing button S1 (labeled as RESET) will generate a system reset. The default version of the phyCORE-LPC3250 SOM populating the phyCORE-LPC3250 Rapid Development Kits is configured to issue a reset via the /RESET_BAT signal. This means that not only are the processor and peripherals reset when S1 is pressed, but the deep sleep circuitry is also reset. If you wish to have a configuration where pressing S1 issues a system reset, but does not reset the sleep circuitry, see section 3 to configure the reset input jumper on the phyCORE-LPC3250 to drive /RESET_SYS instead of the default /RESET_BAT signal.

38 Watchdog Circuit

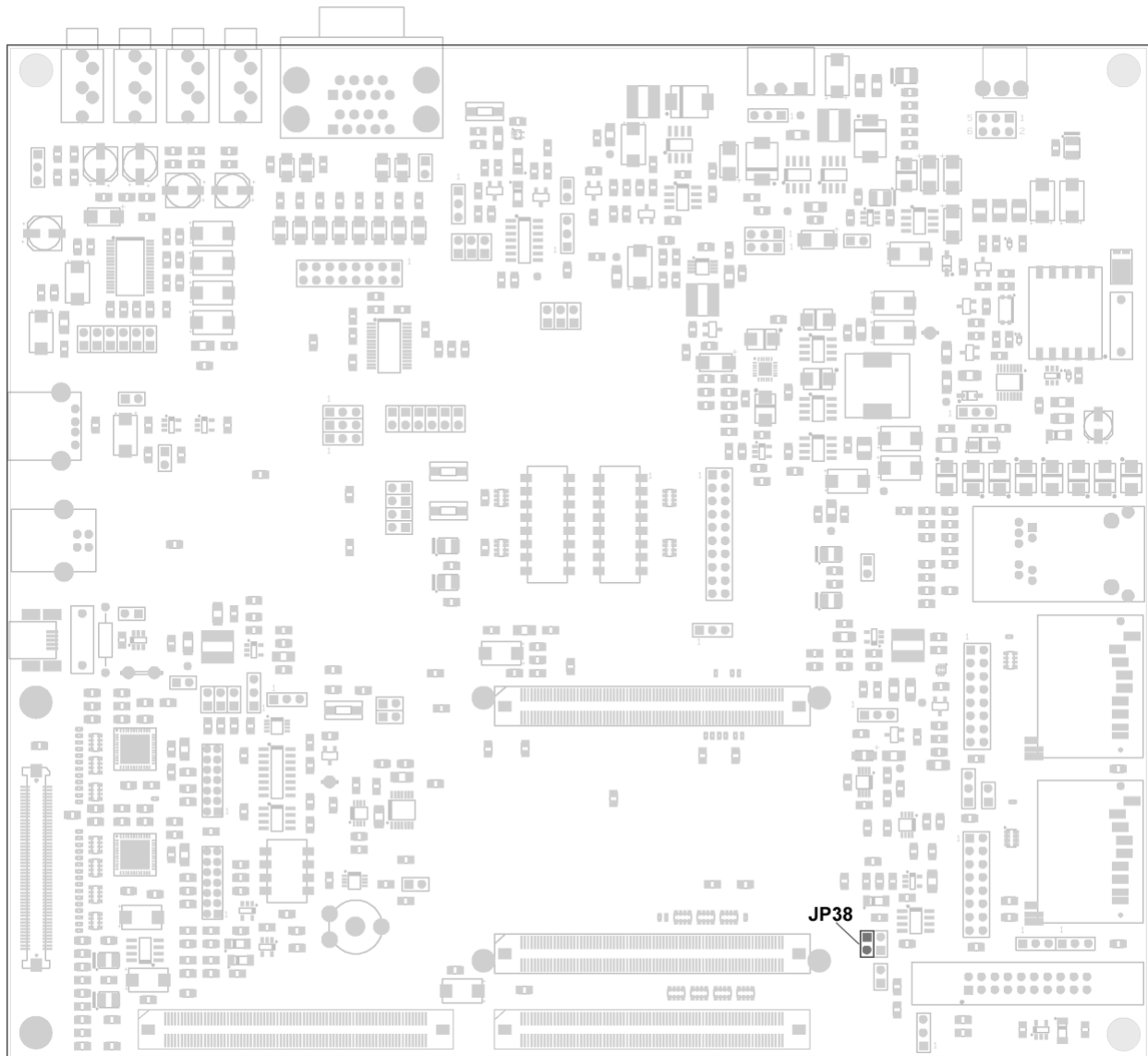

Fig. 38-1. Watchdog Enable Jumper

For mission critical applications the phyCORE-LPC3250 SOM provides a processor independent watchdog circuit to reset the processor should the system hang. To enable the on-board watchdog circuit jumper JP38 must be closed. By default JP38 is open, disabling the watchdog circuit. JP38 controls the connection and disconnection of the processor signal GPO_20. See [Chapter 7](#) for details on making use of the watchdog circuit once enabled.

Part III: PCM-988/GPIO Expansion Board

Part 3 of this 3 part manual provides detailed information on the GPIO Expansion Board and how it enables easy access to most phyCORE-LPC3250 SOM signals.

The information in the following chapters is applicable to the 1190.2 PCB revision of the GPIO Expansion Board.

39 Introduction

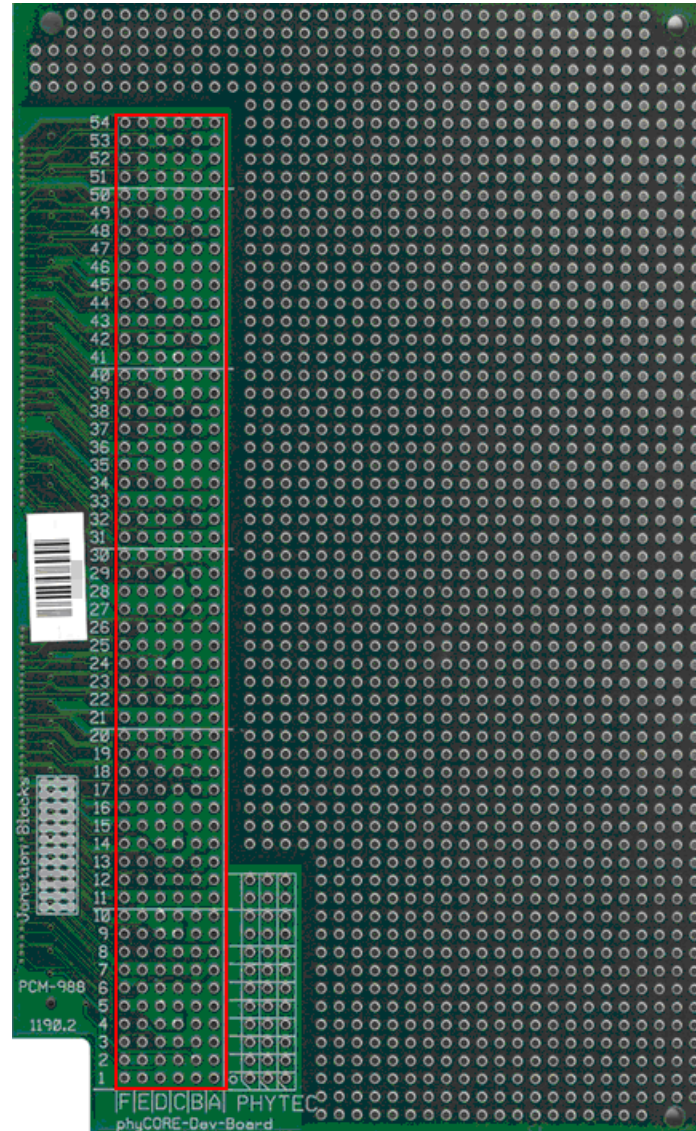

Fig. 39-1. PCM-988/GPIO Expansion Board and Patch Field

The optional PCM-988/GPIO Expansion Board add-on provides an easy means of accessing the phyCORE-LPC3250 SOM signals in addition to Carrier Board generated signals via a 2.54mm/0.1in spaced patch field. The Expansion Board also provides an empty prototyping area for soldering additional test circuits to interface the phyCORE-LPC3250 SOM.

The Expansion Board interfaces the SOM and Carrier Board via the Carrier Board expansion bus connector X2. Nearly all signals from the phyCORE-LPC3250 extend in a strict 1:1 assignment to the Expansion Bus connector. These signals, in turn, are routed in a similar manner to the patch field on the Expansion Board.

A two dimensional numbering matrix similar to the one used for the pin layout of the phyCORE-Connector is provided to identify signals on the Carrier Board Expansion Bus connector X2 as well as the Expansion Board patch field. See [Figure 28-1](#) for the pin numbering on the Carrier Board expansion bus connector

X2. See [Figure 39-1](#) for the pin numbering on the Expansion Board patch field (**red box**). The patch field pin numbering is composed of a row number and a column letter: e.g. 24C. Patch field rows extend from 1 to 54 while columns extend from A to F.

Select phyCORE-LPC3250 signals have been removed from the GPIO expansion connector for signal integrity reasons. [Table 39-1](#) lists the signal groups which have not been routed from the phyCORE-LPC3250 Molex connector to the GPIO Expansion Connector and also provides a reference to where the signals can be located on the Carrier Board.

Table 39-1. Signals Removed from the GPIO Expansion Connector

| Signal Group | Routed To | Chapter |
|------------------------------|--|--------------------|
| SDIO command/clock/control | SDIO access header connector X23 | 31 |
| SD/MMC command/clock/control | SD/MMC access header connector X24 | 30 |
| Digital Ethernet/Keyboard | Ethernet/Keyboard header connector X11 | 32 |
| Analog Ethernet | RJ-45 connector X7 | 25 |
| JTAG | JTAG connector X12 | 22 |

The following chapters and tables, arranged in functional groups, show the relationship between the phyCORE-LPC3250 signal, the location on the GPIO Expansion Bus connector, and where to find the associated signal on the Expansion Board patch field. Please note that because there are a number of multiplexed pins on the LPC3250 processor, a particular pin may fall in multiple groups, and hence will be repeated in several tables.

40 System Signal Mapping

Table 40-1 provides signal mapping for the SOM system signals.

The *Signal* column specifies the signal name used on the phyCORE-Connector and throughout the phyCORE-LPC3250 schematics. The *SOM* column specifies the pin number on the phyCORE-Connector on the SOM (see [Chapter 2](#)). The *Expansion Bus* column specifies the pin number on the GPIO expansion bus connector (see [Chapter 28](#)) on the Carrier Board. The *Patch Field* column specifies the location of the signal on the GPIO Expansion Board patch field.

Table 40-1. System Signal Mapping

| Signal | SOM | Expansion Bus | Patch Field |
|------------|-----|---------------|-------------|
| /RESET_SYS | 10C | 10C | 3D |
| /RESOUT | 11C | 11C | 4E |
| /RESET_BAT | 13C | 13C | 4F |
| /RESIN | 10D | 10D | 3F |
| /SERVICE | 9C | 9C | 3B |
| WDI | 8D | 8D | 3A |
| /FLASH_WP | 18C | 18C | 6E |
| /RTC_INT | 33D | 33D | 11B |
| ONSW | 52D | 52D | 17F |
| TST_CLK2 | 68D | 68D | 23E |

41 Memory Bus Signal Mapping

Table 41-1 provides signal mapping for the SOM memory bus signals for connection of external memory mapped devices.

The *Signal* column specifies the signal name used on the phyCORE-Connector and throughout the phyCORE-LPC3250 schematics. The *SOM* column specifies the pin number on the phyCORE-Connector on the SOM (see Chapter 2). The *Expansion Bus* column specifies the pin number on the GPIO expansion bus connector (see Chapter 28) on the Carrier Board. The *Patch Field* column specifies the location of the signal on the GPIO Expansion Board patch field.

Table 41-1. Memory Bus Signal Mapping

| Signal | SOM | Expansion Bus | Patch Field |
|--------|-----|---------------|-------------|
| b_/CS0 | 5A | 5A | 29E |
| b_/CS1 | 6A | 6A | 29D |
| b_/CS2 | 6B | 6B | 29F |
| b_/CS3 | 5B | 5B | 29B |
| b_/WR | 8A | 8A | 30E |
| b_/OE | 7B | 7B | 30A |
| b_BLS0 | 34A | 34A | 39A |
| b_BLS1 | 33B | 33B | 38F |
| b_BLS2 | 35A | 35A | 39E |
| b_BLS3 | 35B | 35B | 39B |
| b_A0 | 8B | 8B | 30B |
| b_A1 | 9A | 9A | 30D |
| b_A2 | 10A | 10A | 30F |
| b_A3 | 10B | 10B | 31A |
| b_A4 | 11A | 11A | 31E |
| b_A5 | 11B | 11B | 31B |
| b_A6 | 12B | 12B | 31F |
| b_A7 | 13A | 13A | 32A |
| b_A8 | 13B | 13B | 32C |
| b_A9 | 14A | 14A | 32E |
| b_A10 | 15A | 15A | 32B |
| b_A11 | 15B | 15B | 32F |
| b_A12 | 16A | 16A | 33A |
| b_A13 | 16B | 16B | 33C |
| b_A14 | 17B | 17B | 33E |
| b_A15 | 18A | 18A | 33B |
| b_A16 | 23B | 23B | 35B |
| b_A17 | 24A | 24A | 35D |
| b_A18 | 25A | 25A | 35F |
| b_A19 | 25B | 25B | 36A |

Table 41-1. Memory Bus Signal Mapping (Continued)

| Signal | SOM | Expansion Bus | Patch Field |
|---------------|------------|----------------------|--------------------|
| b_A20 | 26A | 26A | 36E |
| b_A21 | 26B | 26B | 36B |
| b_A22 | 27B | 27B | 36F |
| b_A23 | 28A | 28A | 37A |
| b_D0 | 18B | 18B | 33F |
| b_D1 | 19A | 19A | 34A |
| b_D2 | 20A | 20A | 34E |
| b_D3 | 20B | 20B | 34B |
| b_D4 | 21A | 21A | 34D |
| b_D5 | 21B | 21B | 34F |
| b_D6 | 22B | 22B | 35A |
| b_D7 | 23A | 23A | 35E |
| b_D8 | 28B | 28B | 37C |
| b_D9 | 29A | 29A | 37E |
| b_D10 | 30A | 30A | 37B |
| b_D11 | 30B | 30B | 37F |
| b_D12 | 31A | 31A | 38A |
| b_D13 | 31B | 31B | 38C |
| b_D14 | 32B | 32B | 38E |
| b_D15 | 33A | 33A | 38B |
| b_D16 | 37B | 37B | 40A |
| b_D17 | 38A | 38A | 40E |
| b_D18 | 38B | 38B | 40B |
| b_D19 | 39A | 39A | 40D |
| b_D20 | 40A | 40A | 40F |
| b_D21 | 40B | 40B | 41A |
| b_D22 | 41A | 41A | 41E |
| b_D23 | 41B | 41B | 41B |
| b_D24 | 42B | 42B | 41F |
| b_D25 | 43A | 43A | 42A |
| b_D26 | 43B | 43B | 42C |
| b_D27 | 44A | 44A | 42E |
| b_D28 | 45A | 45A | 42B |
| b_D29 | 45B | 45B | 42F |
| b_D30 | 46A | 46A | 43A |
| b_D31 | 46B | 46B | 43C |

42 LCD Signal Mapping

Table 42-1 provides signal mapping for the SOM LCD signals.

The *Signal* column specifies the signal name used on the phyCORE-Connector and throughout the phyCORE-LPC3250 schematics. The *SOM* column specifies the pin number on the phyCORE-Connector on the SOM (see Chapter 2). The *Expansion Bus* column specifies the pin number on the GPIO expansion bus connector (see Chapter 28) on the Carrier Board. The *Patch Field* column specifies the location of the signal on the GPIO Expansion Board patch field.

Table 42-1. LCD Signal Mapping

| Signal | SOM | Expansion Bus | Patch Field |
|----------|-----|---------------|-------------|
| LCD0 | 61A | 61A | 48A |
| LCD1 | 61B | 61B | 48C |
| LCD2 | 60B | 60B | 47F |
| LCD3 | 60A | 60A | 47B |
| LCD4 | 59A | 59A | 47E |
| LCD5 | 58B | 58B | 47C |
| LCD6 | 57B | 57B | 46F |
| LCD7 | 58A | 58A | 47A |
| LCD8 | 56B | 56B | 46B |
| LCD9 | 55B | 55B | 46A |
| LCD10 | 56A | 56A | 46E |
| LCD11 | 55A | 55A | 45F |
| LCD12 | 53B | 53B | 45B |
| LCD13 | 54A | 54A | 45D |
| LCD14 | 53A | 53A | 45E |
| LCD15 | 52B | 52B | 45A |
| LCD16 | 51B | 51B | 44F |
| LCD17 | 51A | 51A | 44D |
| LCD18 | 50B | 50B | 44B |
| LCD19 | 50A | 50A | 44E |
| LCD20 | 49A | 49A | 44A |
| LCD21 | 48A | 48A | 43B |
| LCD22 | 48B | 48B | 43F |
| LCD23 | 47B | 47B | 43E |
| LCDPWR | 62B | 62B | 48E |
| LCDCLKIN | 63B | 63B | 48F |
| LCDFP | 63A | 63A | 48B |
| LCDLP | 64A | 64A | 49A |
| LCDCP | 65A | 65A | 49E |
| LCDAC | 65B | 65B | 49B |
| LCDLE | 66A | 66A | 49D |

43 UART Signal Mapping

Table 43-1 provides signal mapping for the SOM UART signals. All signals that do not end in RS232 are at TTL levels. All signals that end in RS232 are at RS-232 levels.

The *Signal* column specifies the signal name used on the phyCORE-Connector and throughout the phyCORE-LPC3250 schematics. The *SOM* column specifies the pin number on the phyCORE-Connector on the SOM (see Chapter 2). The *Expansion Bus* column specifies the pin number on the GPIO expansion bus connector (see Chapter 28) on the Carrier Board. The *Patch Field* column specifies the location of the signal on the GPIO Expansion Board patch field.

Table 43-1. UART Signal Mapping

| Signal | SOM | Expansion Bus | Patch Field |
|--------------|-----|---------------|-------------|
| U1_RX | 16D | 16D | 6A |
| U1_TX | 17D | 17D | 6C |
| U1_RX_RS232 | 22D | 22D | 7F |
| U1_TX_RS232 | 23D | 23D | 8E |
| U5_RX | 19C | 19C | 6F |
| U5_TX | 20C | 20C | 7A |
| U5_RX_RS232 | 21C | 21C | 7B |
| U5_TX_RS232 | 23C | 23C | 8A |
| /RS232_EN | 20D | 20D | 7E |
| RS232_SD | 21D | 21D | 7D |
| U3_TX | 24C | 24C | 8B |
| U3_RX | 25C | 25C | 8D |
| U3_CTS | 26C | 26C | 9A |
| U3_DSR | 25D | 25D | 8F |
| U3_DTR | 26D | 26D | 9E |
| U3_RTS | 27D | 27D | 9B |
| U3_DCD | 28C | 28C | 9F |
| U3_RI | 28D | 28D | 10A |
| U6_IRTX | 29C | 29C | 10C |
| U6_IRRX | 30D | 30D | 10B |
| /U3_INVALID | N/C | 75B | 25B |
| U3_FORCEON | N/C | 76B | 53C |
| /U3_FORCEOFF | N/C | 77B | 53E |
| U3_RI_DETECT | N/C | 78B | 51A |

44 I²C Signal Mapping

Table 44-1 provides signal mapping for the SOM I²C signals.

The *Signal* column specifies the signal name used on the phyCORE-Connector and throughout the phyCORE-LPC3250 schematics. The *SOM* column specifies the pin number on the phyCORE-Connector on the SOM (see [Chapter 2](#)). The *Expansion Bus* column specifies the pin number on the GPIO expansion bus connector (see [Chapter 28](#)) on the Carrier Board. The *Patch Field* column specifies the location of the signal on the GPIO Expansion Board patch field.

Table 44-1. I²C Signal Mapping

| Signal | SOM | Expansion Bus | Patch Field |
|---------------|------------|----------------------|--------------------|
| I2C1_SCL | 31C | 31C | 10F |
| I2C1_SDA | 32D | 32D | 11C |
| I2C2_SCL | 30C | 30C | 10E |
| I2C2_SDA | 31D | 31D | 11A |

45 GPIO Signal Mapping

Table 45-1 provides signal mapping for the SOM GPI, GPO, and GPIO signals.

The *Signal* column specifies the signal name used on the phyCORE-Connector and throughout the phyCORE-LPC3250 schematics. The *SOM* column specifies the pin number on the phyCORE-Connector on the SOM (see Chapter 2). The *Expansion Bus* column specifies the pin number on the GPIO expansion bus connector (see Chapter 28) on the Carrier Board. The *Patch Field* column specifies the location of the signal on the GPIO Expansion Board patch field.

For convenience purposes four GPO signals are provided in two locations on the GPIO expansion connector at two voltage levels. These signals, GPO 1, 5, 14, and 20, are provided at their normal 1.8V output levels provided by the LPC3250 processor and as level shifted 3.15V signals. The level shifted signals are preceded by a "t" in the signal name. For instance signal GPO_1 is a 1.8V output of the processor, while tGPO_1 is a 3.15V level shifted version of GPO_1. Be aware that these signals are used with other applications on the Carrier Board. Make sure you disconnect these from their respective functions before making use of them on the GPIO Expansion Board patch field. For GPO_1 and GPO_14 see the User LEDs Chapter 34. For GPO_5 see the SD/MMC Chapter 30. For GPO_20 see the Watchdog Circuit Chapter 38.

Table 45-1. GPIO Signal Mapping

| Signal | SOM | Expansion Bus | Patch Field |
|---------|-----|---------------|-------------|
| GPO_0 | 41C | 41C | 14A |
| GPO_1 | 41D | 41D | 14E |
| tGPO_1 | N/C | 76A | 53A |
| GPO_4 | 42D | 42D | 14B |
| GPO_5 | 43C | 43C | 14F |
| tGPO_5 | N/C | 79A | 54A |
| GPO_11 | 43D | 43D | 15A |
| GPO_14 | 44C | 44C | 15C |
| tGPO_14 | N/C | 78A | 53B |
| GPO_17 | 45D | 45D | 15B |
| GPO_19 | 45C | 45C | 15E |
| GPO_20 | 18D | | 33F |
| tGPO_20 | N/C | 80A | 54E |
| GPI_3 | 39C | 39C | 13B |
| GPI_4 | 51D | 51D | 17D |
| GPI_7 | 40D | 40D | 13F |
| GPI_19 | 40C | 40C | 13D |
| GPIO_0 | 38C | 38C | 13A |
| GPIO_1 | 38D | 38D | 13E |

46 USB Signal Mapping

Table 46-1 provides signal mapping for the SOM USB signals.

The *Signal* column specifies the signal name used on the phyCORE-Connector and throughout the phyCORE-LPC3250 schematics. The *SOM* column specifies the pin number on the phyCORE-Connector on the SOM (see [Chapter 2](#)). The *Expansion Bus* column specifies the pin number on the GPIO expansion bus connector (see [Chapter 28](#)) on the Carrier Board. The *Patch Field* column specifies the location of the signal on the GPIO Expansion Board patch field

Table 46-1. USB Signal Mapping

| Signal | SOM | Expansion Bus | Patch Field |
|---------------|------------|----------------------|--------------------|
| USB_ADR/PSW | 46C | 46C | 15F |
| USB_ID | 46D | 46D | 16A |
| USB_D+ | 47D | 47D | 16C |
| USB_D- | 48D | 48D | 16B |
| USB_VBUS | 48C | 48C | 16E |

47 SSP Signal Mapping

Table 47-1 provides signal mapping for the SOM SSP signals.

The *Signal* column specifies the signal name used on the phyCORE-Connector and throughout the phyCORE-LPC3250 schematics. The *SOM* column specifies the pin number on the phyCORE-Connector on the SOM (see [Chapter 2](#)). The *Expansion Bus* column specifies the pin number on the GPIO expansion bus connector (see [Chapter 28](#)) on the Carrier Board. The *Patch Field* column specifies the location of the signal on the GPIO Expansion Board patch field

Table 47-1. SSP Signal Mapping

| Signal | SOM | Expansion Bus | Patch Field |
|---------------|------------|----------------------|--------------------|
| SCK0 | 49C | 49C | 16F |
| MISO0 | 50C | 50C | 17A |
| MOSI0 | 50D | 50D | 17E |
| SSEL0 | 51C | 51C | 17B |

48 I²S Signal Mapping

Table 48-1 provides signal mapping for the SOM I²S signals.

The *Signal* column specifies the signal name used on the phyCORE-Connector and throughout the phyCORE-LPC3250 schematics. The *SOM* column specifies the pin number on the phyCORE-Connector on the SOM (see Chapter 2). The *Expansion Bus* column specifies the pin number on the GPIO expansion bus connector (see Chapter 28) on the Carrier Board. The *Patch Field* column specifies the location of the signal on the GPIO Expansion Board patch field

Table 48-1. I²S Signal Mapping

| Signal | SOM | Expansion Bus | Patch Field |
|------------|-----|---------------|-------------|
| I2STX_CLK1 | 53C | 53C | 18A |
| I2STX_SDA1 | 54C | 54C | 18B |
| I2STX_WS1 | 55C | 55C | 18D |
| I2SRX_CLK1 | 55D | 55D | 18F |
| I2SRX_SDA1 | 56D | 56D | 19E |
| I2SRX_WS1 | 57D | 57D | 19B |

49 Power Signal Mapping

Table 49-1 provides signal mapping for the SOM power signals. These signals include all VCC and ground pins.

The *Signal* column specifies the signal name used on the phyCORE-Connector and throughout the phyCORE-LPC3250 schematics. The *SOM* column specifies the pin number on the phyCORE-Connector on the SOM (see Chapter 2). The *Expansion Bus* column specifies the pin number on the GPIO expansion bus connector (see Chapter 28) on the Carrier Board. The *Patch Field* column specifies the location of the signal on the GPIO Expansion Board patch field

Table 49-1. Power Signal Mapping

| Signal | SOM | Expansion Bus | Patch Field |
|------------|--|--|--|
| VCC | 1C, 2C, 1D, 2D | 1C, 2C, 1D, 2D | 1A, 1C |
| VCC_SDIO | 4C, 5C | 4C, 5C | 2A, 1B |
| VCC_AD_EXT | 4D, 5D | 4D, 5D | 2C, 1D |
| VDS_3V0 | 6C | 6C | 2B |
| AGND | 77C, 79D | Connected to GND | Connected to GND |
| GND | 2A, 7A, 12A, 17A, 22A, 27A, 32A, 37A, 42A, 47A, 52A, 57A, 62A, 67A, 72A, 77A, 4B, 9B, 14B, 19B, 24B, 29B, 34B, 39B, 44B, 49B, 54B, 59B, 64B, 69B, 74B, 79B, 3C, 7C, 12C, 17C, 22C, 27C, 32C, 37C, 42C, 47C, 52C, 57C, 62C, 67C, 72C, 3D, 9D, 14D, 19D, 24D, 29D, 34D, 39D, 44D, 49D, 54D, 59D, 64D, 69D, 74D | 2A, 7A, 12A, 17A, 22A, 27A, 32A, 37A, 42A, 47A, 52A, 57A, 62A, 67A, 72A, 77A, 4B, 9B, 14B, 19B, 24B, 29B, 34B, 39B, 44B, 49B, 54B, 59B, 64B, 69B, 74B, 79B, 3C, 7C, 12C, 17C, 22C, 27C, 32C, 37C, 42C, 47C, 52C, 57C, 62C, 67C, 72C, 77C 3D, 9D, 14D, 19D, 24D, 29D, 34D, 39D, 44D, 49D, 54D, 59D, 64D, 69D, 74D, 79D | 3C, 4C, 7C, 8C, 9C, 12C, 13C, 14C, 17C, 18C, 19C, 22C, 23C, 24C, 27C, 29C, 30C, 31C, 34C, 35C, 36C, 39C, 40C, 41C, 44C, 45C, 46C, 49C, 50C, 51C, 54C, 4D, 5D, 6D, 9D, 10D, 11D, 14D, 15D, 16D, 19D, 20D, 21D, 24D, 25D, 26D, 28D, 31D, 32D, 33D, 36D, 37D, 38D, 41D, 42D, 43D, 46D, 47D, 48D, 51D, 52D, 53D, 1E, 2E, 1F |

Revision History

Table 50-1. Revision History

| Date | Version Number | Changes in this Manual |
|-------------|-----------------------|-------------------------------|
| 09/02/2008 | L-714e_0 | Preliminary release. |
| 01/21/2009 | L-714e_1 | First official release. |

Index

A

ADC potentiometer 109
audio interface 80

B

battery
 automatic switch-over 31
 charging circuit 70
block diagram, SOM 4
board configuration data, *see* EEPROM

boot

Kickstart Loader 37
mode selection 110
modes 34
NAND Flash 34
process 34
secondary bootloader 35
sequence 38
Stage 1 Loader 37

bus buffers

ICs at U1, U2, U3, U4, and U5 50
memory map 50
signal mapping 50
voltage select 51

C

Carrier Board 57
CB, *see* Carrier Board
chip selects 42, 50
Common Driver Library 40
current measurement
 Carrier Board 71
 SOM 27

D

debug interface
 Carrier Board 72
 compatible JTAG probes 73
 SOM 49
deep sleep, Carrier Board
 3.0V supply at U11 79
 block diagram 76
 description 75
 state diagram 78
deep sleep, SOM
 block diagram 30
 description 30
dimensions, SOM 52

E

EEPROM
 configuration data 40
 densities 39
 U19 40
Ethernet

connector 82
easy access header X11 103
jumpers 44, 83
MAC ID 40
PHY at U6 43
PHY operating mode 44

F

features list, SOM 2

G

GPIO Expansion Board
 description 114
 GPIO signal map 122
 I2C signal map 121
 I2S signal map 125
 LCD signal map 119
 memory bus signal map 117
 patch field 114
 power signal map 126
 SSP signal map 124
 system signal map 116
 UART signal map 120
 USB signal map 123
GPIO expansion connector 91

H

humidity 52

I

I2C1, external RTC 32

J

JTAG, *see* debug interface
jumpers, Carrier Board
 J3 70
 J4 71
 J5 79
 J6 100
 J7 71
 JP1 81
 JP10 81
 JP11 81
 JP12 81
 JP13 81
 JP14 83
 JP15 78
 JP17 78
 JP18 79
 JP19 79
 JP2 70
 JP20 79
 JP21 110
 JP22 79
 JP23 108
 JP24 79

JP25 106
 JP26 109
 JP27 108
 JP28 106
 JP29 94
 JP3 78
 JP30 73
 JP31 94
 JP32 95
 JP33 95
 JP34 85
 JP35 98
 JP36 98
 JP37 98
 JP38 112
 JP39 69, 83
 JP4 100
 JP40 90
 JP41 73
 JP42 68, 69
 JP43 71
 JP44 67, 70
 JP45 67, 79
 JP46 79
 JP48-50 90
 JP5 85
 JP51 90
 JP52 85
 JP53 95
 JP54 95
 JP55 95
 JP56 95
 JP57 95
 JP58 74
 JP6 98
 JP7 81
 JP8 81
 JP9 81
 settings summary 62
 jumpers, SOM
 EEPROM configuration 41
 external RTC configuration 32
 external watchdog configuration 33
 locations (connector side) 20
 locations (controller side) 19
 NAND Flash write protect 39
 settings summary 19, 20
 VCC_1V2 & VCC_1V8 settings 26
 VCC_CORE configuration 27
 VCC_RTC & VCC_SDRAM settings 27

K

keyboard
 connectivity 102
 disabling ethernet interface 102

pull-up/pull-down resistors 102
 switch S5 pull-downs 103
 switch S5 pull-ups 102

L

LCD

bit modes 88
 connectivity 86
 CPLDs 87
 signal mapping through CPLDs 87

M

MAC ID *see* Ethernet

memory

EEPROM 40
 map 42
 NAND Flash 39
 NOR Flash 40
 NOR vs. NAND 40
 SDRAM 39

N

NAND Flash

densities 39
 IC at U8 39
 write protect 39

NOR Flash

address ranges 40
 densities 39
 ICs at U12, U13 40
 write protect 40

P

pin description, SOM 7

power, Carrier Board

1.8V supply at U10 71
 3.0V supply at U11 79
 3.15V supply at U9 70
 5.0V supply at U21 71
 battery input 69
 current measurement 71
 power path controller 71
 Power-over-Ethernet 69
 wall input 68

power, SOM 24

consumption 52
See also VCC, SOM

Power-over-Ethernet 69

PSE options 69

R

reset

/RESET_BAT 33, 74
 /RESET_SYS 33, 74
 JTAG /SRST 73
 system reset button 111
 thresholds 28

revision history 127

RS-232

- configuring UART2 & 3 operation 95
- connecting to UART2 and 3 93
- connecting to UART5 93
- connectivity 92
- enable and shutdown 43
- transceiver U25 43
- RTC
 - external 32
 - internal 3
- S**
- SD/MMC
 - card power control 97
 - configuration jumpers 98
 - connectivity 97
 - easy access header X15 97
- SDIO
 - adjustable power supply 100
 - clocking 48
 - configuration jumpers 100
 - connectivity 99
 - controller IC at U14 47
 - easy access header X23 100
 - interface signals 48
 - power control 48
 - signal mapping 47
 - VCC_SDIO 24, 25
- SDRAM
 - address ranges 39
 - densities 39
 - initialization 34
 - memory ICs at U10, U11 39
- serial interfaces 43
 - ethernet 43
 - RS-232 43
 - USB 45
- settings summary 62
- solder jumper, *see* jumper
- SOM connectivity to Carrier Board 65
- SOM, *see* System on Module
- SPI EEPROM, *see* EEPROM
- Stage 1 Loader, *see* boot
- system memory, *see* memory
- System on Module 1
- T**
- technical specifications 52
- temperature
 - operating 52
 - storage 52
- U**
- USB
 - applicable connectors 46
 - connectivity 84
 - external power supply 45
 - I2C address 45
 - transceiver IC at U24 45
 - VBUS capacitance 45
 - VBUS current 45
- user ADC potentiometer 109
- user buttons 105
- user LEDs 107
- V**
- VBAT 24
- VCC, SOM
 - adjustable VCC_CORE supply 25, 27
 - fixed VCC_1V2 supply 25
 - fixed VCC_1V8 supply 25
 - fixed VCC_RTC supply 27
 - fixed VCC_SDRAM supply 27
 - input power 24
 - VCC_AD_EXT inputs 24
 - VCC_SDIO inputs, *see* SDIO
- VFP 2
- voltage supervisor 28
- W**
- watchdog
 - enable jumper 112
 - overview 33
- weight 52